



Assembly and Operating Instructions



max. 120 kg



~ 60 Min. 



 54 kg

L 127 | W 70 | H 107

FSCSTBC70B2.02.01

Art. No. CST-BC70-B-2

Recumbent Bike **BC70**

Content

1	GENERAL INFORMATION	8
1.1	Technical Data	8
1.2	Personal Safety	9
1.3	Electrical Safety	10
1.4	Set-Up Place	11
2	ASSEMBLY	12
2.1	General Instructions	12
2.2	Scope of Delivery	13
2.3	Assembly	15
3	OPERATING INSTRUCTIONS	22
3.1	Console display	22
3.2	Button functions	23
3.3	Turn on the machine	24
3.4	Programmes	26
3.4.1	QUICK START in the manual programme	27
3.4.2	Manual Mode	27
3.4.3	Profile programmes	28
3.4.4	User-defined programmes	30
3.4.5	Watt-controlled programme	31
3.5	Heart rate control	32
3.6	Recovery	33
3.7	Check or delete saved data	34
3.8	Battery compartment	37
3.9	Heart-rate measuring	38
4	STORAGE AND TRANSPORT	40
4.1	General Instructions	40
4.2	Transportation Wheels	40
5	TROUBLESHOOTING, CARE AND MAINTENANCE	41
5.1	General Instructions	41
5.2	Faults and Fault Diagnosis	41
5.3	Error Codes and Troubleshooting	42
5.4	Maintenance and Inspection Calendar	42
6	DISPOSAL	42

7	RECOMMENDED ACCESSORIES	43
8	ORDERING SPARE PARTS	44
8.1	Serial Number and Model Name	44
8.2	Parts List	45
8.3	Exploded Drawing	48
9	WARRANTY	50
10	CONTACT	52

Dear customer,

thank you for choosing fitness equipment from cardiostrong®. cardiostrong offers high-quality home fitness equipment that is optimally adapted to the conditions at home. Train at home no matter what the weather or time of the day. cardiostrong fitness equipment offers training programmes and a variety of equipment for all training levels and all training goals.

Further information can be found at www.fitshop.com or www.cardiostrong.de.

We hope you enjoy your training!

Intended Use

The equipment may only be used for its intended purpose.

The equipment is only suitable for home use. The equipment is not suitable for semi-professional (e.g. hospitals, associations, hotels, schools, etc.) and commercial or professional use (e.g. fitness studios).

Legal Notice

Fitshop GmbH
Europe's No. 1 for home fitness

International Headquarters
Flensburger Straße 55
24837 Schleswig
Germany

Management:
Christian Grau
Sebastian Campmann
Dr. Bernhard Schenkel
No. HRB 1000 SL
Local Court Flensburg
European VAT Number: DE813211547

Disclaimer

© cardiostrong is a registered brand of the company Fitshop GmbH. All rights reserved. Any use of this trademark without the explicit written permission of Fitshop is prohibited.

Product and manual are subject to change. Technical data can be changed without advance notice.

FITSHOP

Europe's No.1 for Home Fitness

ABOUT THIS MANUAL

Please carefully read the entire manual before installation and first use. The manual will help you to quickly set up the system and explains how to safely use it. Make sure that all persons exercising with the equipment (especially children and persons with physical, sensory, mental or motor disabilities) are informed about this manual and its contents in advance. In case of doubt, responsible persons must supervise the use of the equipment.

Due to ongoing changes and software optimisations, the manual may have to be updated. If you notice any discrepancies during assembly or use, please refer to the manual uploaded to the webshop. The latest manual is always available there.

This equipment has been manufactured according to the latest safety knowledge. As far as possible, potential safety hazards which could cause injury have been eliminated. Make sure to carefully follow the instructions and that all parts are securely in place. If required, read through the instructions again to correct any mistakes.



Training devices must be classified according to accuracy and use. Accuracy classes are only applicable to devices that display training data.

Accuracy classes

Class A: high accuracy.

Class B: medium accuracy.

Class C: low accuracy.

The use classes explain the intended use of the training device.

Use classes

Class S (studio): professional and/or commercial use.

These training devices are intended for the use in training rooms of facilities such as sports clubs, school facilities, hotels, clubs and studios whose access and supervision is specifically regulated by the owner (person with legal responsibility).

Class H (home use): use at home.

These stationary training devices are intended for the use in private homes where access to the training device is regulated by the owner (person with legal responsibility).

Please pay close attention to the safety and maintenance instructions given here. The contract partner cannot be held liable for damage to health, accidents or damage to the equipment when it is not used in accordance with these instructions.

The following safety instructions may appear in this manual:

► **ATTENTION**

This notice indicates potentially hazardous situations which, if not avoided, may result in property damage.

⚠ **CAUTION**

This notice indicates potentially hazardous situations which, if not avoided, may result in slight or minor injuries!

⚠ **WARNING**

This notice indicates potentially hazardous situations which, if not avoided, may result in death or serious injuries!

⚠ **DANGER**

This notice indicates potentially hazardous situations which, if not avoided, will result in death or serious injuries!

ⓘ **NOTICE**

This notice indicates further useful information.

Retain these instructions in a safe place for future reference, maintenance or when ordering replacement parts.

1.1 Technical Data

LED display

- + Speed in km/h
- + Training time in min
- + Training distance in km
- + Cadence (rotations per minute)
- + Calorie consumption
- + Heart rate (when using the hand pulse sensors or a chest strap)
- + Power output in watts
- + Resistance level

Resistance system:	electronic magnetic brake system
Resistance level:	16
Watt:	10 - 350 watt

User memory:	5
Total number of training programs:	19
Manual programs:	1
Pre-set programs:	12
Watt-controlled programs:	1
Heart rate controlled programs:	4
User defined programs:	1

Flywheel mass:	9 kg
Pedal arm length:	17 cm
Bottom bracket width:	8 cm

Weight and dimensions

Article weight (gross, including packaging):	61 kg
Article weight (net, without packaging):	54 kg

Packaging dimensions (L x W x H):	approx. 135 cm x 32 cm x 75 cm
Set-up dimensions (L x W x H):	approx. 127 cm x 70 cm x 107 cm
Maximum user weight:	120 kg

Use class:	H
------------	---

1.2 Personal Safety

DANGER

- + Before you start using the equipment, you should consult your physician that this type of exercise is suitable for you from a health perspective. Particularly affected are persons who: have a hereditary disposition to high blood pressure or heart disease, are over the age of 45, smoke, have high cholesterol values, are overweight and/or have not exercised regularly in the past year. If you are under medical treatment that affects your heart rate, medical advice is absolutely essential.
- + Note that excessive training can seriously endanger your health. Please also note that heart rate monitoring systems can be inaccurate. If you notice any signs of weakness, nausea, dizziness, pain, shortness of breath, or other abnormal symptoms, stop exercising immediately and seek advice from your doctor if necessary.
- + The owner must communicate all warnings and instructions to the user.

WARNING

- + This equipment may not be used by children under the age of 14.
- + Children should not be allowed unsupervised access to the equipment.
- + Persons with disabilities must have a medical license and must be under strict observation when using the equipment.
- + The equipment is strictly for use by one person at a time.
- + If your equipment provides a safety key, the clip of the safety key must be attached to your clothing before starting your training. In the event of a fall, the EMERGENCY STOP of the equipment can be initiated.
- + There is a risk of injury from spinning pedals and/or an exposed flywheel in the absence of a freewheel. Never get on or off the equipment when the pedals or the flywheel are still moving. Always make sure that the pedals and the flywheel have come to a complete stop.
- + Support yourself with at least one hand on the handlebar when getting on and off the equipment. Only dismount from the equipment when the pedals have come to a complete stop.
- + Keep your hands, feet and other body parts, hair, clothing, jewellery and other objects well clear of moving parts.
- + During use, wear suitable sports clothing rather than loose or baggy clothing. When wearing sports shoes, make sure they have suitable soles, preferably made of rubber or other non-slip materials. Shoes with heels, leather soles, studs or spikes are unsuitable. Never exercise barefoot.

CAUTION

- + If your equipment needs to be connected to the power supply with a mains cable, make sure that the cable is not a potential tripping hazard.
- + Make sure that nobody is within the range of motion of the equipment during training so as not to endanger you or other persons.
- + Always tighten the pedal strap before you start training to prevent your feet from slipping.



CAUTION

- + Be aware that if adjustment devices are left protruding, they may impede the user's movement.

▶ ATTENTION

- + Do not insert any objects of any kind into the openings of the device.
- + To protect the equipment from use by unauthorised third parties, always remove the power cable when not in use and store it in a safe place that is inaccessible to unauthorised persons (e.g. children).
- + Class B and C crank training equipment is not suitable for high accuracy purposes.

1.3 Electrical Safety



DANGER

- + In order to reduce the risk of an electric shock, always unplug the equipment from the mains socket immediately after your workout, before assembly or dismantling, and before maintenance or cleaning. Do not pull on the cable.



WARNING

- + Do not leave the equipment unattended while the mains cable is plugged into the mains socket. During your absence, the mains cable must be removed from the mains socket to prevent improper use by third parties or children.
- + If the mains cable or plug is damaged or defective, contact your contract partner. Until repair, the equipment must not be used.

▶ ATTENTION

- + The equipment requires a mains connection of 220-230 V with 50 Hz mains voltage.
- + The equipment may only be connected directly to an earthed socket using the supplied mains cable. Extension cables must conform to VDE guidelines. Always completely unwind the mains cable.
- + The socket must be protected by a fuse with a minimum fuse rating of "16 A, slow blow".
- + Do not make any changes to the mains cable or the mains plug.
- + Keep the mains cable away from water, heat, oil and sharp edges. Do not route the mains cable underneath the equipment or under a carpet or rug, and do not place any objects on top of it.
- + If your purchased item is equipped with a TFT console, software updates must be carried out regularly. Follow the instructions on the console to perform the update(s).
- + The software systems on gym equipment with TFT consoles are set up only for the pre-installed apps. Do not install any additional apps.



NOTICE

- + The pre-installed apps on TFT consoles are produced and provided by external manufacturers. Fitshop does not take any responsibility for the availability, functionality or contents of these apps.

1.4 Set-Up Place

WARNING

- + Do not place the equipment in main corridors or escape routes.

CAUTION

- + Choose a location in which to place the equipment such that there is enough free space/clearance to the front, the rear and to the sides of the equipment.
- + The training room should be well ventilated during training and not be exposed to any draughts.
- + Choose the place in which to set up the equipment such that there is enough free space/clearance to the front, the rear and to the sides of the equipment.
- + The free area in the direction from which the exercise equipment is accessed must be at least 0.6 m larger than the exercise area.
- + The set-up and mounting surface of the equipment should be flat, loadable and solid.

ATTENTION

- + The device may only be used in one building, in sufficiently tempered and dry rooms (ambient temperatures between 10°C and 35°C). The equipment should not be used outdoors or in rooms with high humidity (over 70%) like swimming pools.
- + A floor protective mat/equipment underlay can help to protect high-quality floor coverings (parquet, laminate, cork, carpets) from dents and sweat and can help to level out slight unevenness.
- + For Class S equipment, the exercise equipment may only be used in areas where access, supervision and control are specifically regulated by the owner.

2.1 General Instructions



DANGER

- + Do not leave any tools, packaging materials such as foils or small parts lying around, as otherwise there is a danger of suffocation for children. Keep children away from the equipment during assembly.



WARNING

- + Pay attention to the instructions attached to the equipment in order to reduce the risk of injuries.



CAUTION

- + Ensure to have sufficient room for movement in each direction during assembly.
- + The assembly of the equipment must be carried out by at least two adults. If in doubt, seek the help of a third technically skilled person.



ATTENTION

- + To prevent damage to the equipment and the floor, assemble the equipment on a mat or packaging board.



NOTICE

- + In order to make the assembly as simple as possible, some screws and nuts to be used can already be pre-assembled.
- + Ideally, assemble the equipment at its later set-up place.

2.2 Scope of Delivery

The scope of delivery consist of the following parts. At the beginning, check whether all parts and tools belonging to the device are included in the scope of delivery and whether damage has occurred. In the event of complaints, the contractual partner must be contacted directly.

⚠ CAUTION

If parts of the scope of delivery are missing or damaged, the assembly must not be carried out.

📄 NOTICE

Batteries are not included in the scope of delivery. The following batteries are required: 2 x AA

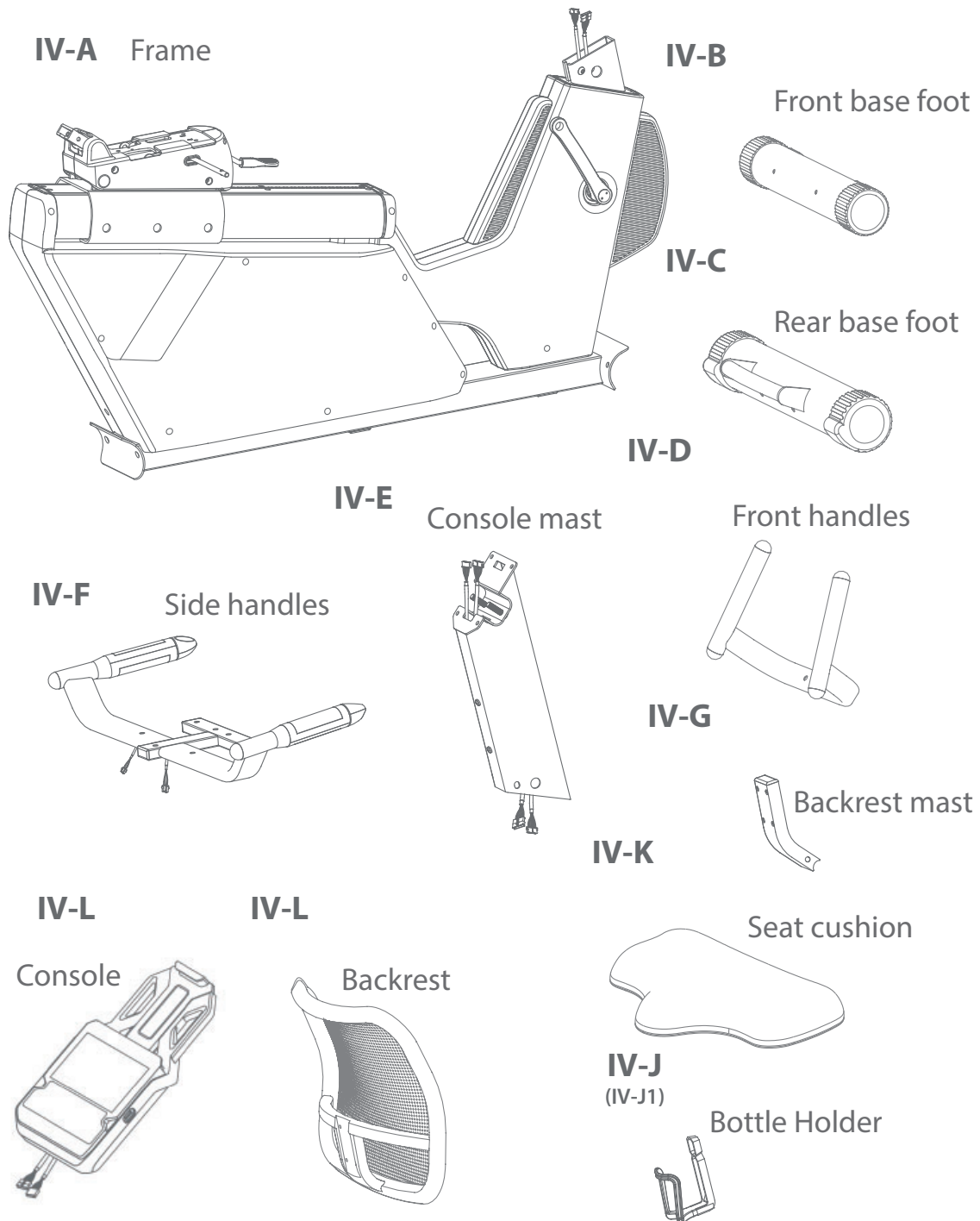

IV-M

IV-M1 & IV-M2 Pedal

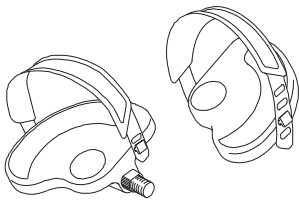

**IV-M3 & IV-M4
Cover**

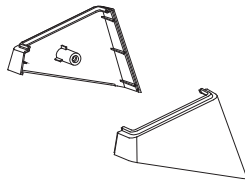

IV-M5 Lever

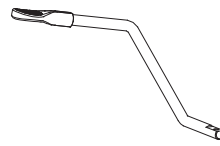

IV-M6 Plug

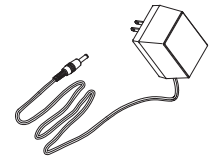

IV-N

IV-N1 Screw

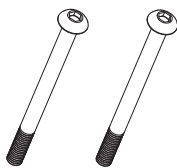

IV-N2 Washer

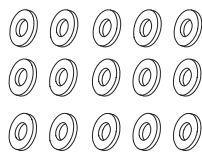

IV-N3 Screw



IV-N4 Screw



IV-N6 Screw



IV-N7 Screw



IV-N9 Nut



IV-N10 Screw

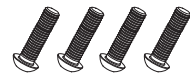

IV-N11 Adjusting lever



IV-N13 Screw



IV-N15 Spring washer



IV-N16 Screw

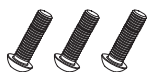

2.3 Assembly

Before assembly, take a close look at the individual assembly steps shown and carry out the assembly in the order given.

① NOTICE

- + First loosely screw all parts together and check that they fit properly. Tighten the screws using the tool only when you are instructed to do so.
- + If you have difficulty recognising the graphics, we recommend that you open and/or download the PDF instructions stored in the webshop on your end device (e.g. smartphone, tablet or PC). There you have the option of zooming in closer. Please note that the Adobe Acrobat Reader programme must be installed on your end device in order to open the file.

Step 1: Assembly of the front and back feet

1. Mount the rear base foot (IV-C) on the frame (A) with two washers (IV-N2), two spring washers (IV-N15) and two screws (IV-N1).
2. Then mount the front base foot (IV-B) on the frame (A) with two washers (IV-N2), two spring washers (IV-N15) and two screws (IV-N3).

① NOTICE

If the equipment is not stable after construction, adjust the setting screws on the underside of the base foot (IV-C1) correspondingly.

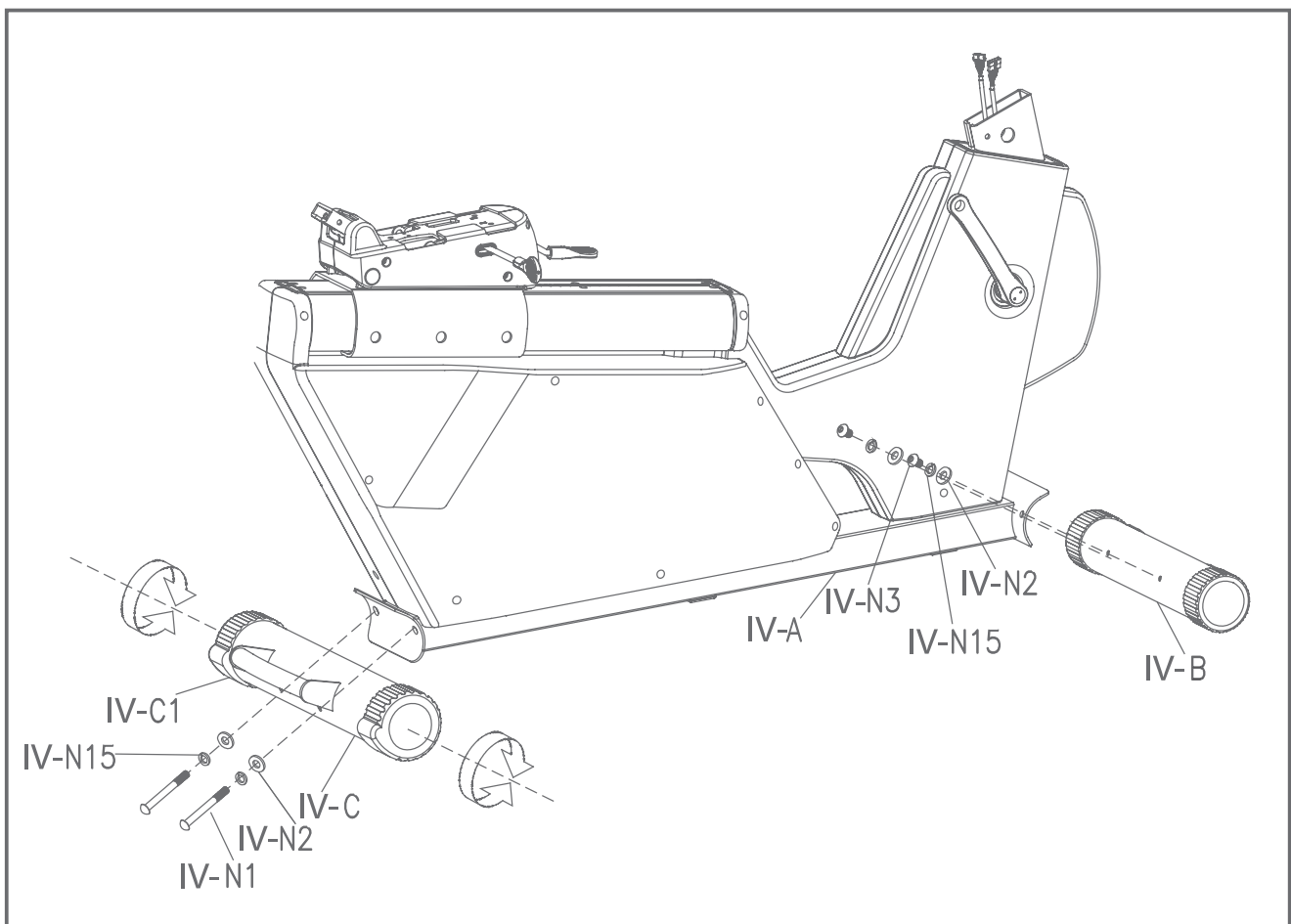

Step 2: Assembly of the console mast

1. First loosen the screws (IV-N12) from the frame.
2. Connect the sensor cables (IV-E1 and IV-E2) from the console mast with the sensor cables (IV-A1 and IV-A2) from the frame.
3. Mount the console mast (IV-E) on the frame (IV-A) with two screws (IV-N12).
4. Slide the covers (IV-M3 and IV-M4) on the frame (IV-A) and mount with two screws (IV-N6).



WARNING

Make sure to not pinch the cables.

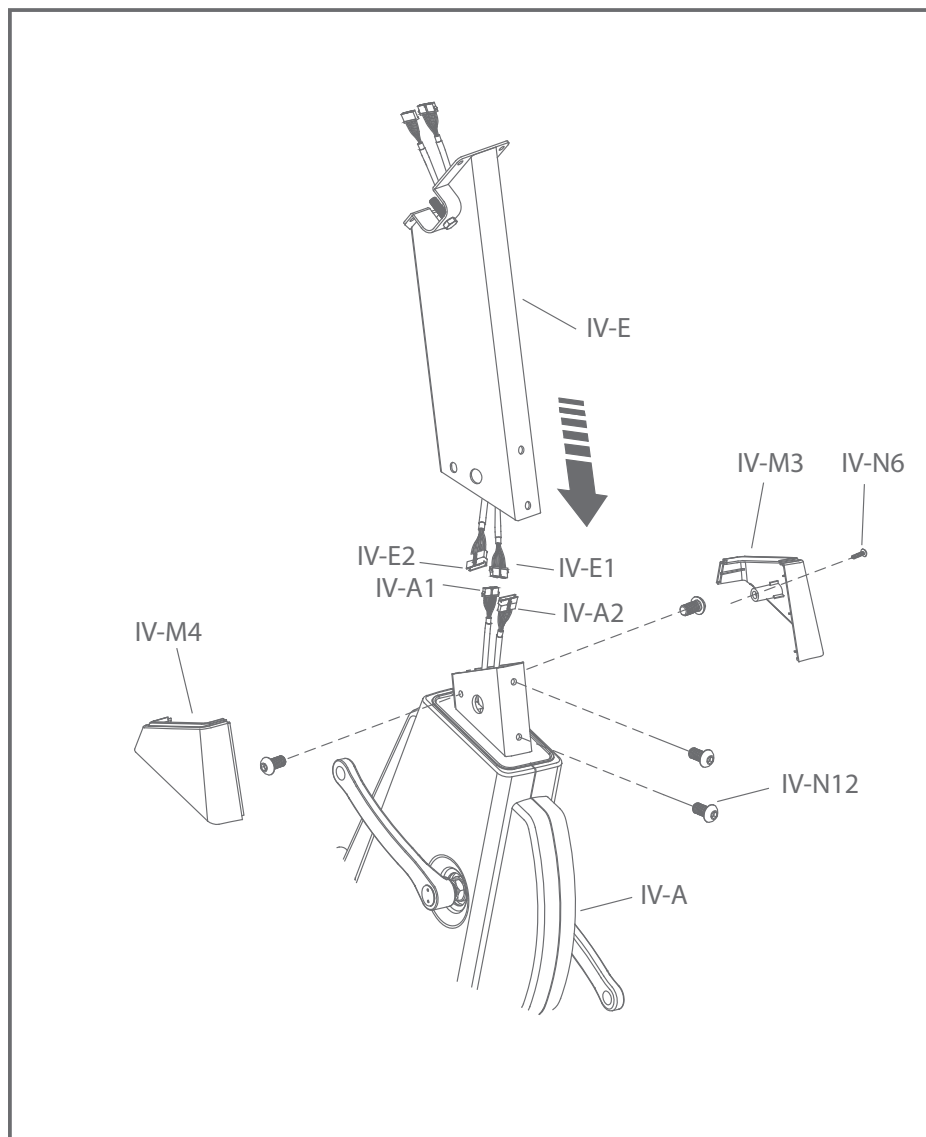

Step 3: Assembly of the upper handles and the console

1. Set the upper handles (IV-D) on the iron plate of the console mast (IV-E) and mount with two nuts (IV-N9).
2. Loosen the four screws (IV-H1) from the console (IV-H).
3. Connect the sensor cables (IV-E1 and IV-E2) from the console mast with the cables from the console. Make sure that the cables are properly connected with each other.
4. Push the cable carefully into the console mast and mount the console (IV-H) on the console mast (IV-E) with two screws (IV-H1).
5. Release the two screws (IV-N14) from the central tube (IV-E), equip the bottle holder (IV-J1) with the central tube (IV-E) with the two screws (IV-N14).

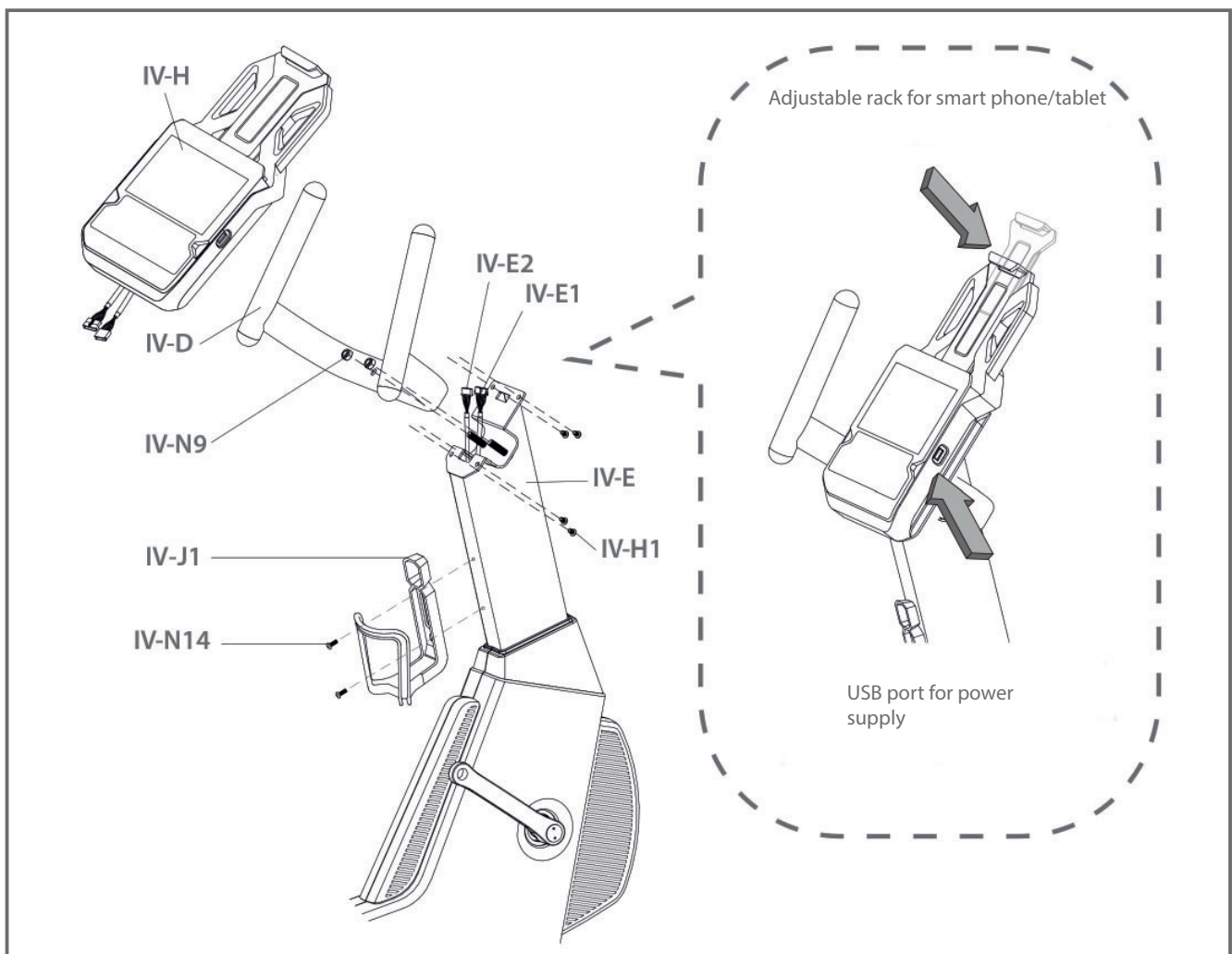

Step 4: Assembly of the backrest mast and the side handles

1. Mount the backrest mast (IV-G) on the frame (IV-A) with two screws (IV-N4) and washers (IV-N2).
2. Connect the sensor cables (IV-F5 and IV-F4) from the handle with the sensor cables (IV-A2) from the frame.
3. Move the side handles (IV-F) on the frame (IV-A) and mount the parts with three screws (IV-N16) and three washers.

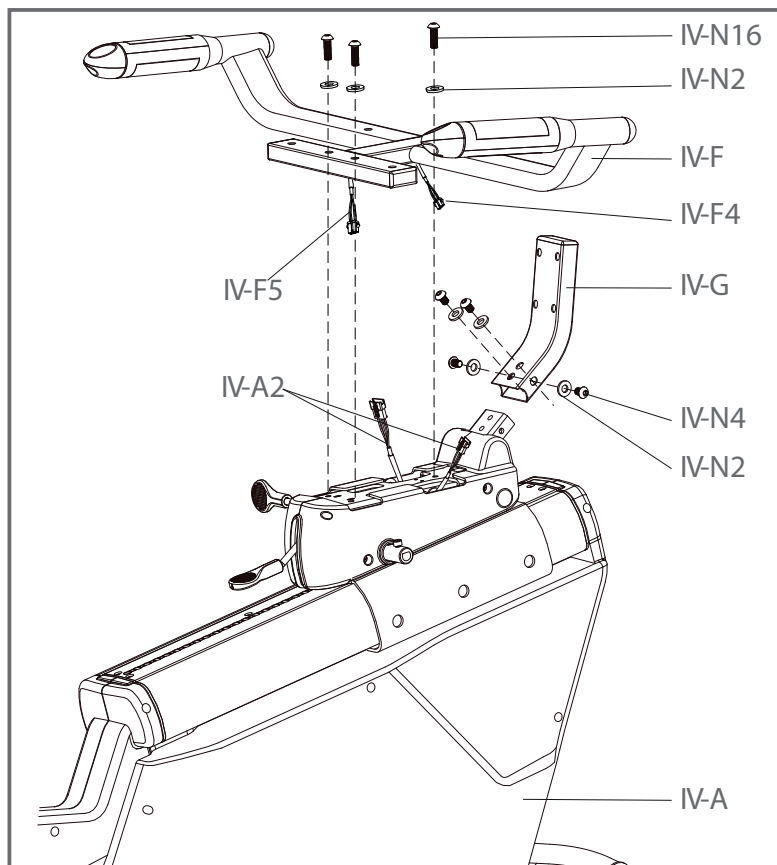

Step 5: Assembly of the backrest and the seat cushion

1. Mount the backrest (IV-L) on the backrest mast (IV-G) with four screws (IV-N7).
2. Mount the seat cushion (IV-K) on the frame of the side handles (IV-F) with four washers (IV-N2) and four screws (IV-N10).

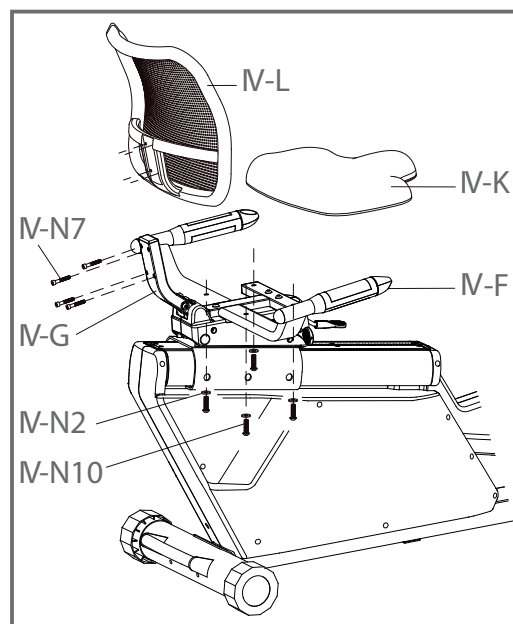

Step 6: Assembly of the adjusting lever

Push the adjusting lever (IV-M5) into the frame (IV-A) and mount it with a stop screw (IV-N13).

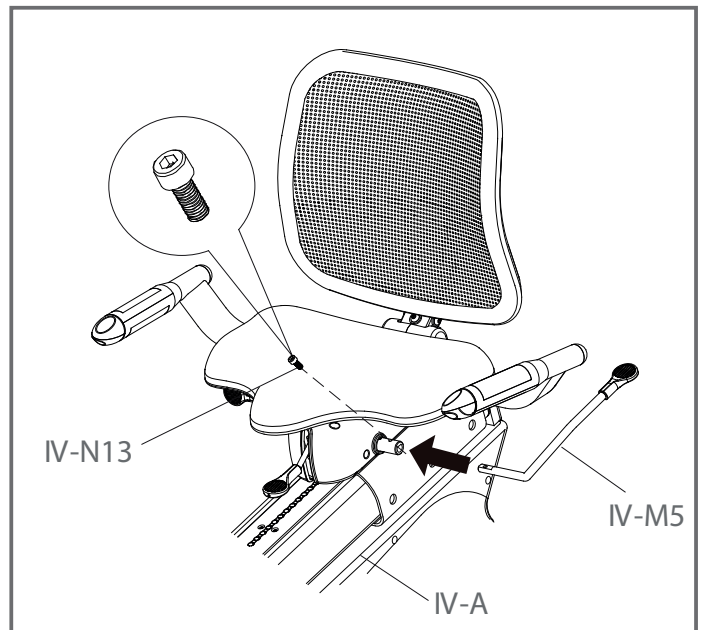

Step 7: Assembly of the pedals

1. Move the right pedal on to the right crank and mount it by turning the pedal clockwise.
2. Move the left pedal on to the left crank and mount it by turning the pedal counter-clockwise.



CAUTION

Make sure to screw in the pedals completely.

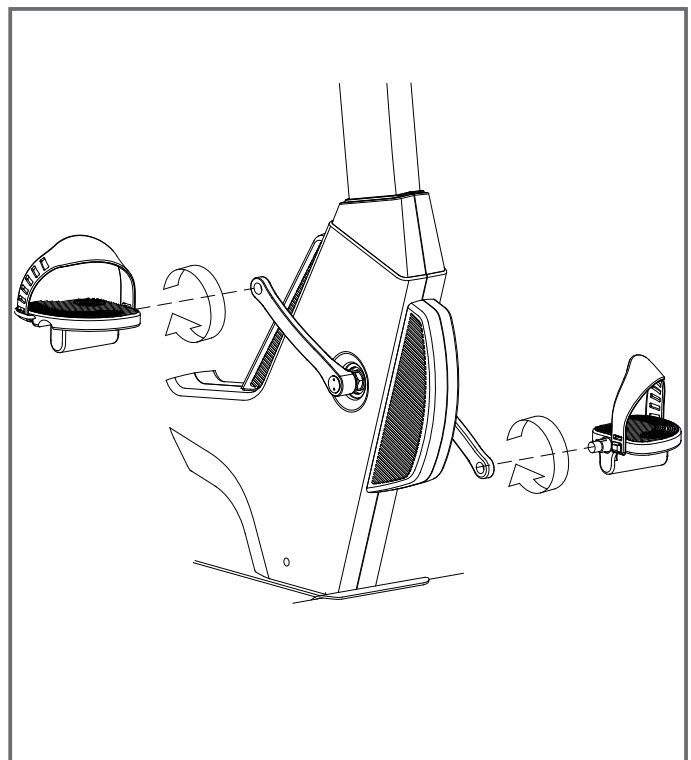

Step 8: Alignment of the Feet

If the floor is uneven, you can stabilize the equipment by turning the two setting screws under the main frame.

1. Lift the equipment on the desired side and rotate the setting screws under the main frame.
2. Rotate the screws clockwise in order to remove them and to raise the equipment.
3. Rotate them counterclockwise in order to lower the equipment.

Step 9: Connecting the Equipment to the Mains Supply

► ATTENTION

The equipment must not be connected to a multiple socket, otherwise it cannot be guaranteed that the equipment will be supplied with sufficient power. Technical errors can result.

Plug the power plug into a wall outlet that complies with the instructions in the chapter on electrical safety.

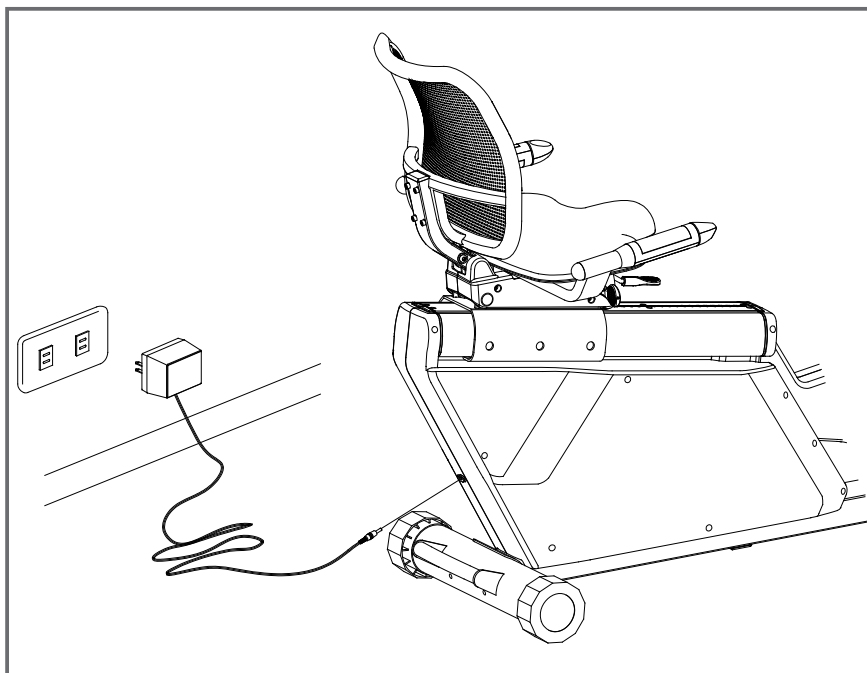

Correctly Getting On and Off

1. To get on, grip the handles with both hands and first step onto the left pedal with your left foot or onto the right pedal with your right foot and then place your foot onto the other pedal.
2. To get off, grip the handles with both hands and place one foot next to the equipment and then the other foot.

Step 10: Adjusting the backrest

Press the adjusting lever back, move the seat to the desired position and move the adjusting lever back to the front.

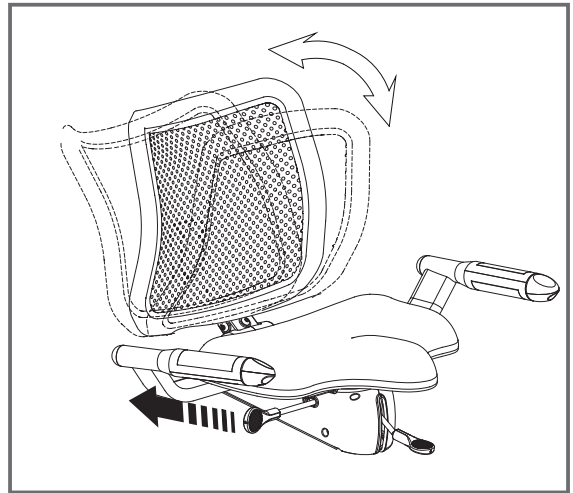

Step 11: Adjusting the seat

Pull the lever (IV-G44) up, place the seat at the desired distance and move the lever back down.

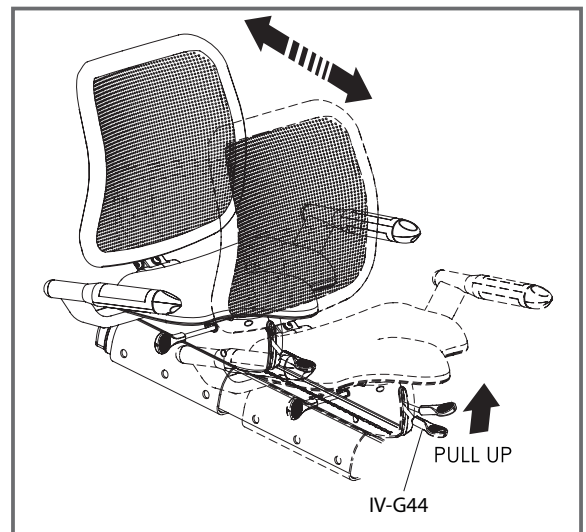

Step 12: Adjusting the seat angle

Pull the lever (IV-M5) up to increase the seat angle and push it down to decrease the seat angle.

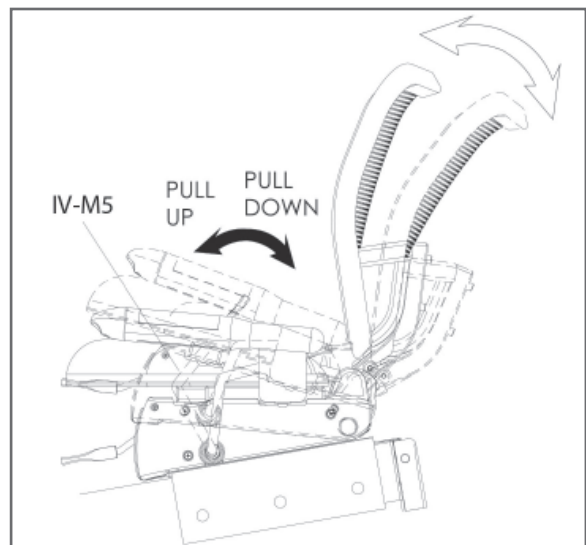

3 OPERATING INSTRUCTIONS

NOTICE

- + Familiarise yourself with all the functions and setting options of the device before starting training. Have the proper use of this product explained to you by a specialist.
- + Always start your training with low intensity and increase evenly and gently. End your training with a cool-down phase. If you are unsure, please consult your physician.

3.1 Console display



Time	The time counts from 00:00 to a maximum of 99:59 in 1-minute increments.
Speed	Displays the current speed. The maximum speed is 99.9 km/h or mph.
RPM (cadence; rotations per minute)	Displays the rotations per minute. Range from 0 to 999 RPM.
Distance	Counts the total distance from 0.0 to 999.9 km or miles in increments of 0.1 kilometres or miles.

Calories (calorie consumption)	Counts the calories consumption from 0 to a maximum of 9999 calories during the training. The unit for reducing or increasing is 10 kcal. (This values serve as rough guides for comparing with different training sessions. However, they cannot be used for medical treatment.)
Pulse (heart rate; beats per minute)	Set a target pulse from 0 – 30 to 230.
Watt/Load (output/resistance)	Displays the current training wattage. Range from 0 to 999.

3.2 Button functions

START/STOP	Start or stop the training. Press it in the Standby mode to start Quick Start in the MANUAL programme.
DOWN	Reduce the functional values or the training resistance
UP	Increase the functional values or the training resistance
ENTER	Confirm the settings
RESET	Reset the current setting, the screen returns to the initial training mode in the selection. Hold it pressed for two seconds in the Standby mode to reset all.
RECOVERY	Activate the recovery function.
RECORDED DATA	Press in the Stop mode to check the data.
SAVE/DELETE	SAVE: Press STOP to stop the training. The display asks whether you want to save the data. Press SAVE. DELETE: When you check the saved data, press DELETE. The system asks whether you really want to delete the data. Confirm with ENTER.
PROGRAMM MODE	Quick key to enter program mode function.
HEART RATE CONTROL	Quick key to enter heart rate control function.
WATT CONSTANT	Quick key to enter Watt constant function.

3.3 Turn on the machine

1. Connect the monitor to the power and press RESET for two seconds.

The LCD screen displays all segments for two seconds and a signal sounds (see fig. 1).

2. Go to the settings of calendar and time (fig. 2 to 5).
3. Set the time and the calendar with the UP/DOWN buttons.
4. Confirm with ENTER.



Fig. 1



Fig. 2



Fig. 3



Fig. 4



Fig. . 5

- To choose the user (U) form 1 to 4, press the UP/DOWN buttons.
- Confirm with ENTER (fig. 6).
- Enter the user data for gender, age, height, and weight (fig. 7 to 10).



Fig. 6



Fig. 7

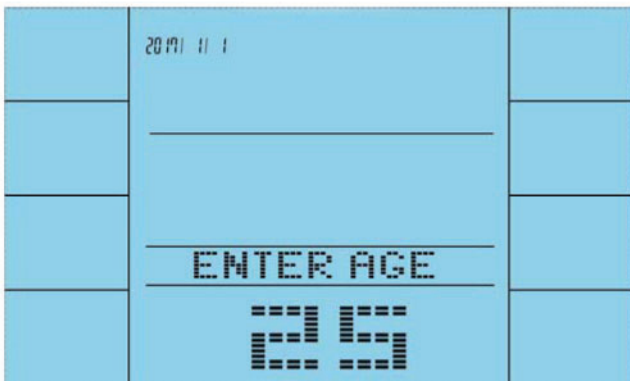

Fig. 8

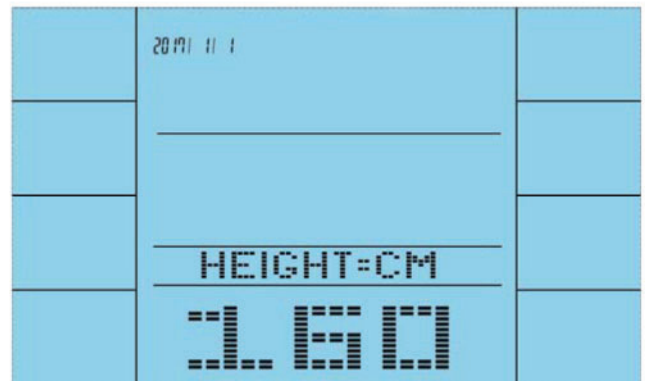

Fig. 9



Fig. 10

3.4 Programmes

The programmes can be chosen as followed:

MANUAL - PROGRAM - USER PROG - WATT - H.R.C. (fig. 11 to 15).

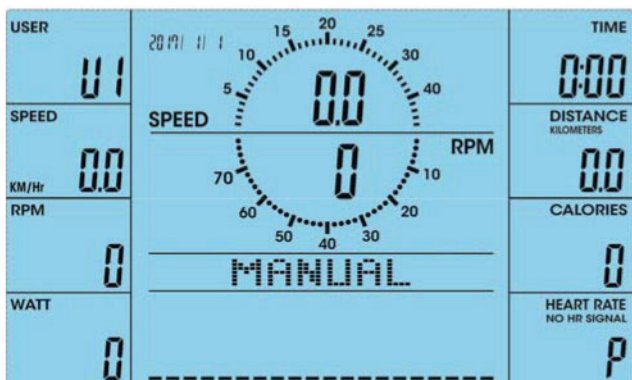

Fig. 11

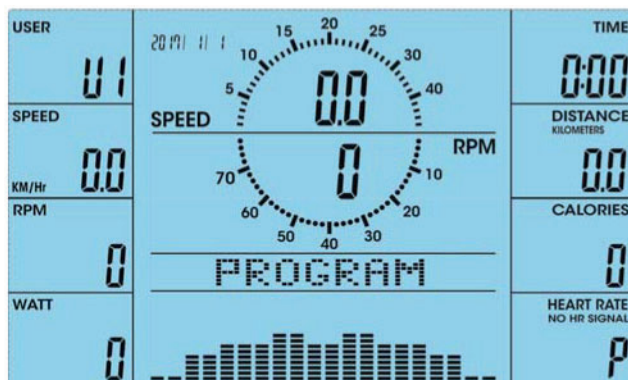

Fig. 12



Fig. 13

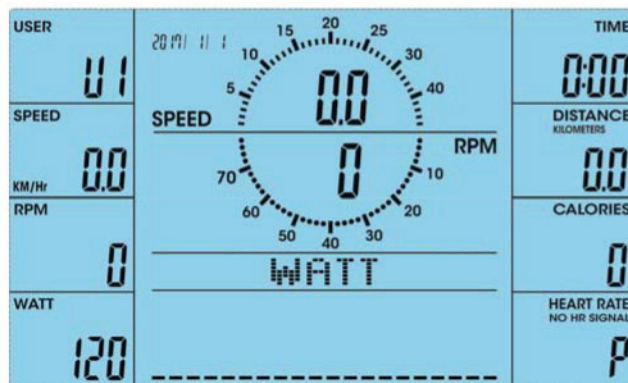

Fig. 14

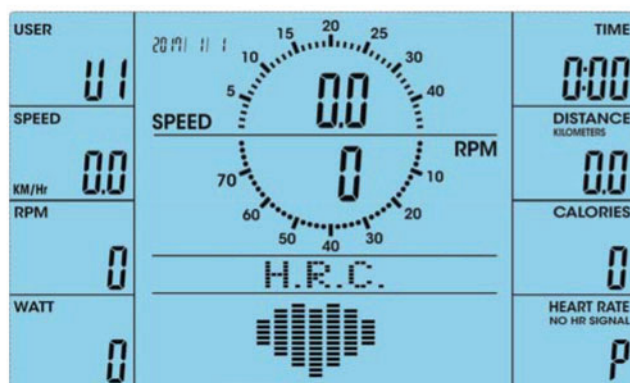

Fig. 15

3.4.1 QUICK START in the manual programme

1. Press ENTER in the MANUAL programme (fig. 19).
2. Press START/STOP to start the training (fig. 20). The resistance can be adjusted during the training.
3. Press START/STOP to stop the training.

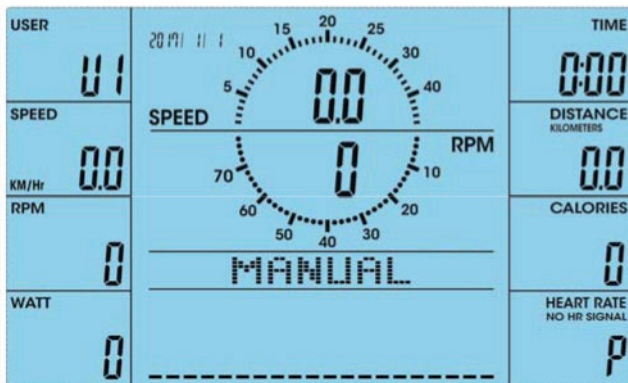

Fig. 16



Fig. 17

3.4.2 Manual Mode

1. Choose the MANUAL mode and confirm with ENTER (fig. 16.).
2. Increase or reduce the intensity level (from 1 to 6) with the UP/DOWN buttons. Confirm with ENTER.

ⓘ NOTICE

Target values for TIME/DISTANCE/CALORIES/PULSE can be pre-set.

3. To start the training, press START/STOP (fig. 17).
4. To return to the MANUAL mode, press RESET.

ⓘ NOTICE

The resistance can be adjusted during the training.

3.4.3 Profile programmes

1. After entering the PROGRAM mode (fig. 18) you can choose one of the 12 hill programs with the UP/DOWN buttons (fig. 19 to 30).
2. Confirm with ENTER.

NOTICE

The TIME can be pre-set.

3. Press START/STOP to start the training (fig. 31).

After the training starts, the time is counted down. When the time reaches zero, the screen lights up and a signal sounds. To stop the signal, press any button.

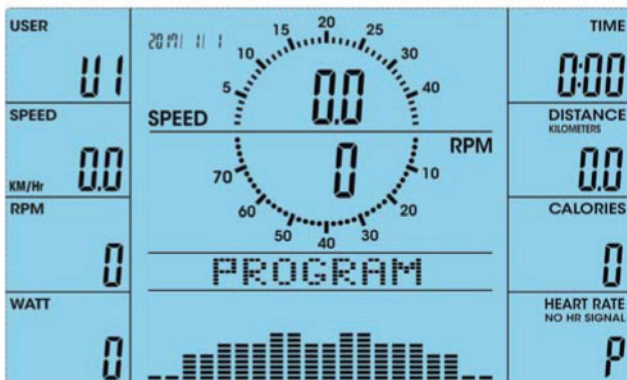

Fig. 18

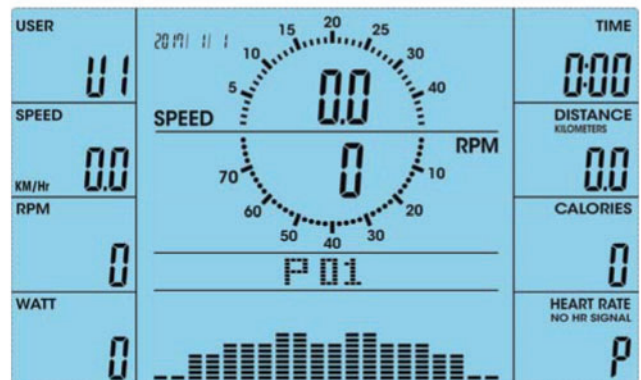

Fig. 19

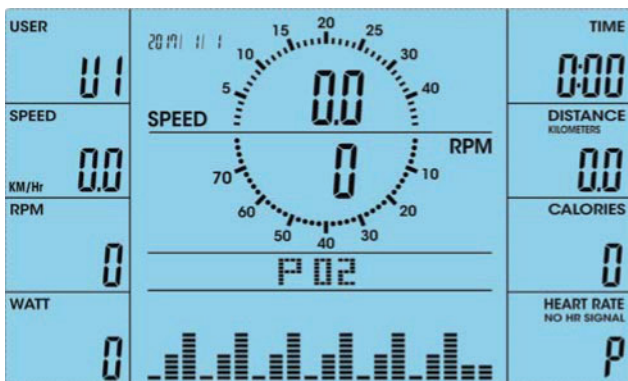

Fig. 20

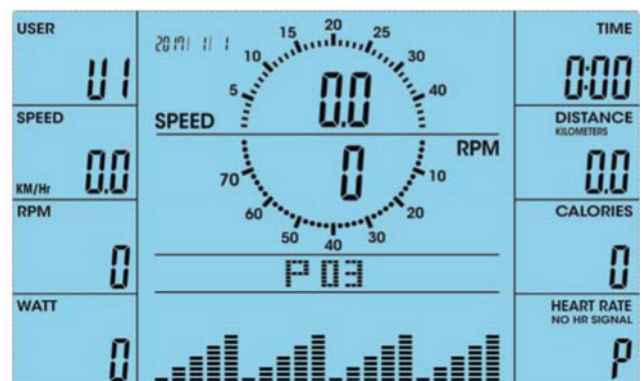

Fig. 21

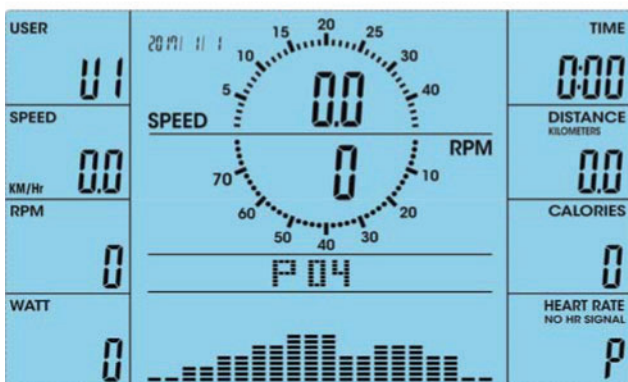

Fig. 22

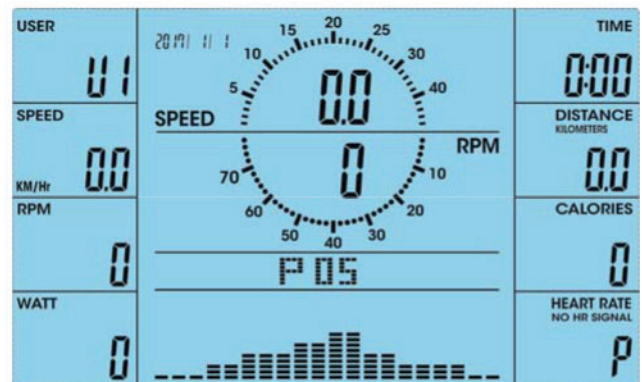

Fig. 23



Fig. 24



Fig. 25

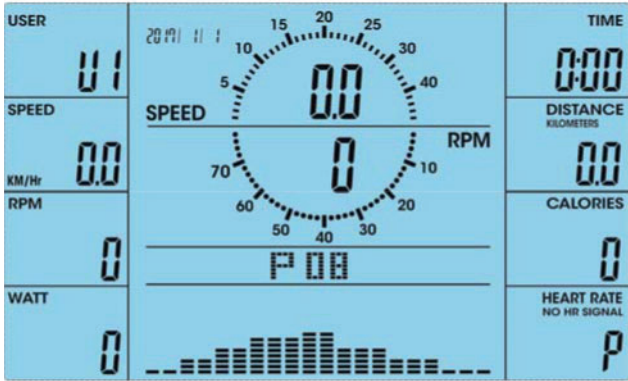

Fig. 26

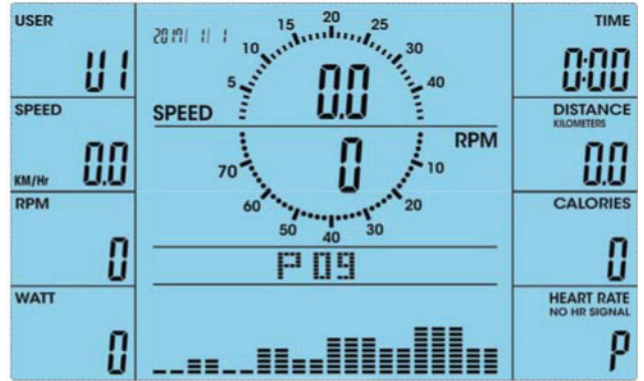

Fig. 27

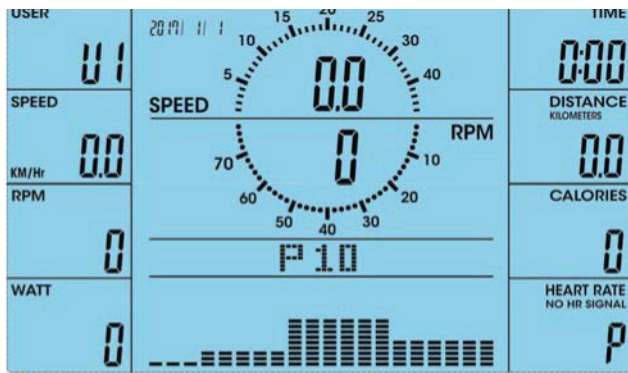

Fig. 28

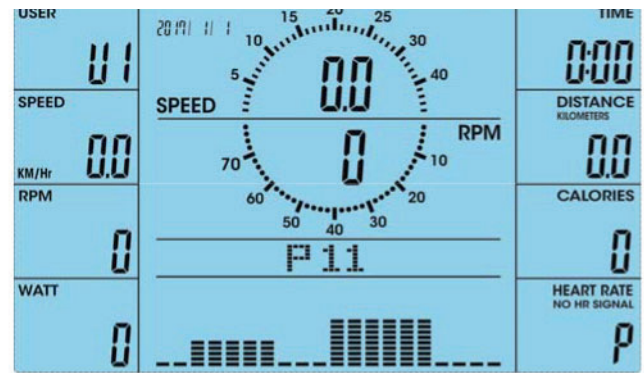

Fig. 29

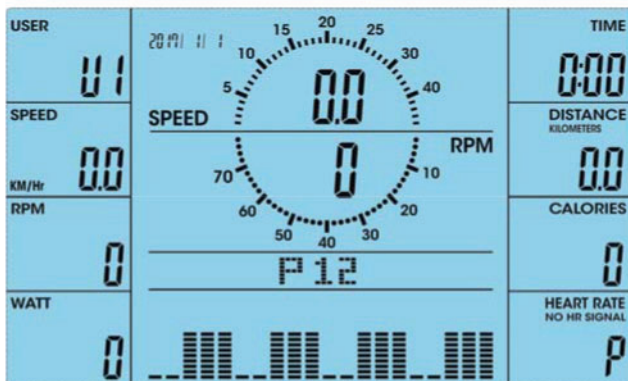

Fig. 30

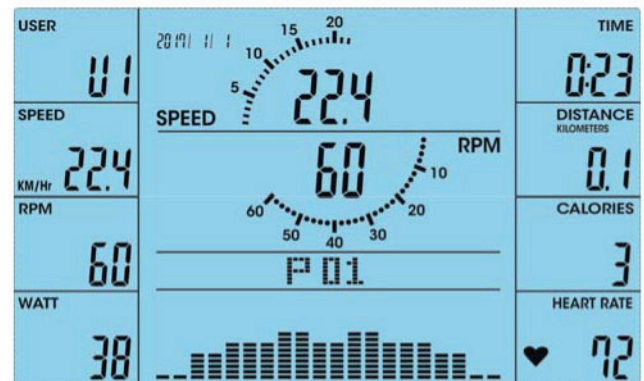

Fig. 31

3.4.4 User-defined programmes

1. When you entered the USER PROG (PROGRAM mode, fig. 32) the first section blinks (fig. 33). You can increase or reduce the intensity level (from 1 to 6) with the UP/DOWN buttons for all the 20 sections.
2. If you set the intensity level for all sections, press and hold ENTER for two seconds. The profile program will now be saved and you can continue by entering the training time.
3. You can enter target values for TIME, DISTANCE, CALORIES and PULSE. The training will automatically be ended when the target value is reached. To skip the target entering and immediately start with the training, press START/STOP (fig. 43). To return to the settings in the MANUAL mode, press RESET.



Fig. 32

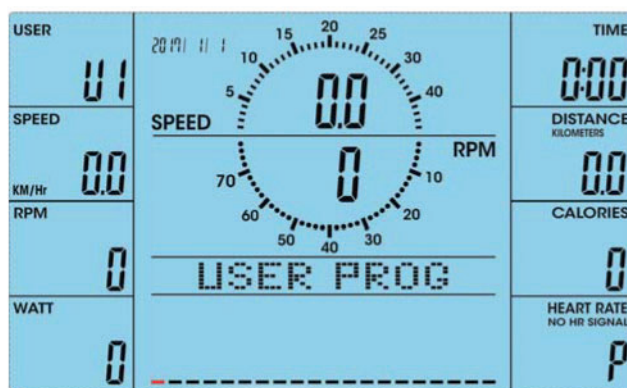

Fig. 33

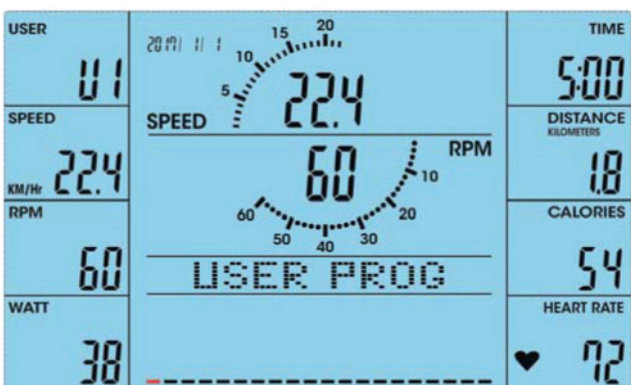

Fig. 34

3.4.5 Watt-controlled programme

1. Select the watt-controlled programme (WATT mode).

The pre-set value of 120 Watt blinks. You can set the value between 10 and 350 Watt with the UP/DOWN buttons.

2. To set the target values, press ENTER.
3. To immediately start the training, press START.

NOTICE

You can enter target values for TIME, DISTANCE and CALORIES. The training will automatically be ended when the target value is reached. To skip the target entering and immediately start with the training, press START/STOP.

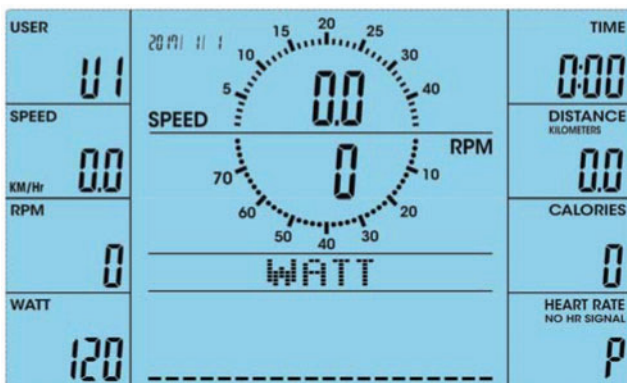

Fig. 35

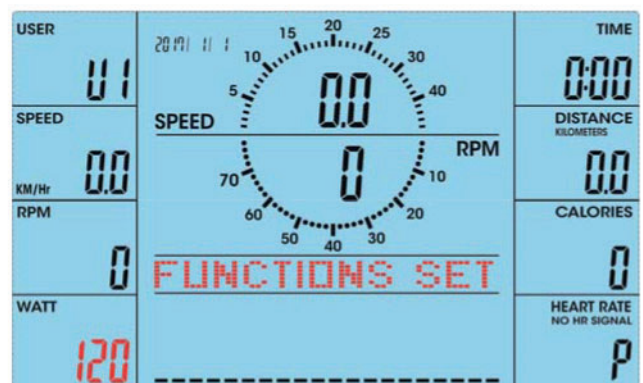

Fig. 36

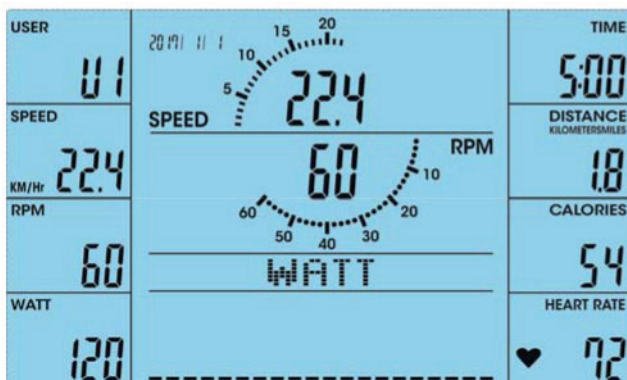

Fig. 37

3.5 Heart rate control

WARNING

Your training equipment is not a medical device. The heart rate measurement of this equipment may be inaccurate. Various factors can affect the accuracy of the heart rate measurement. The heart rate measurement serves only as a training aid.

In the H.R.C. mode (fig. 38), the screen displays 55%, 75%, 90%, and TARGET (fig. 39 to 42).

1. Choose the preferred heart rate with the UP/DOWN buttons.
2. Set the desired time.
3. To start the training, press START/STOP.

After the training start, the time is counted down. When zero is reached, the screen lights up and a signal sounds. To top the signa, press any button.

NOTICE

When there is no pulse for six seconds, the LCD screen displays PULSE INPUT as reminder until a pulse is set (fig. 43).

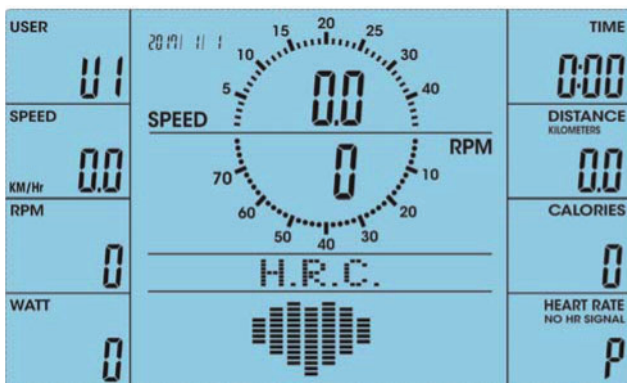

Fig. 38

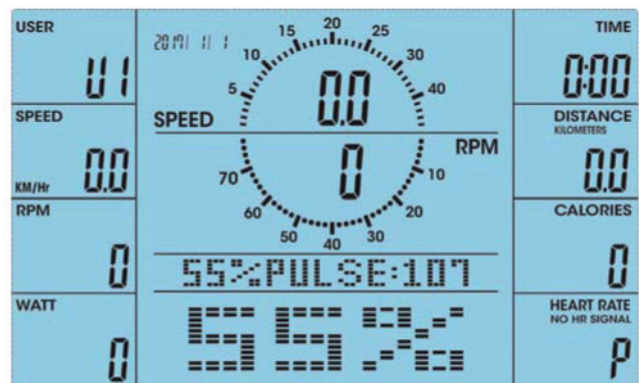

Fig. 39

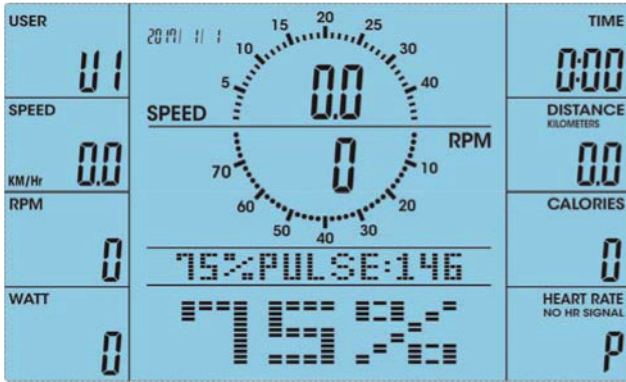

Fig. 40

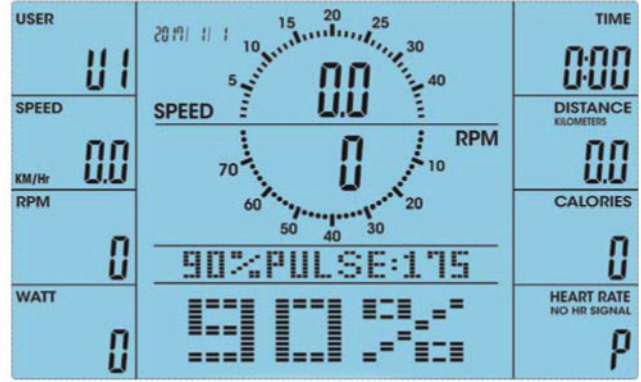

Fig. 41

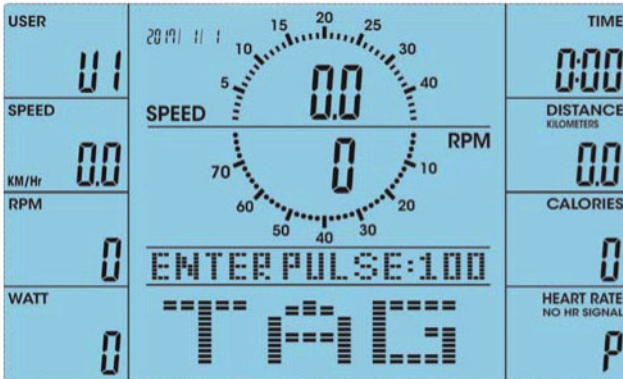

Fig. 42

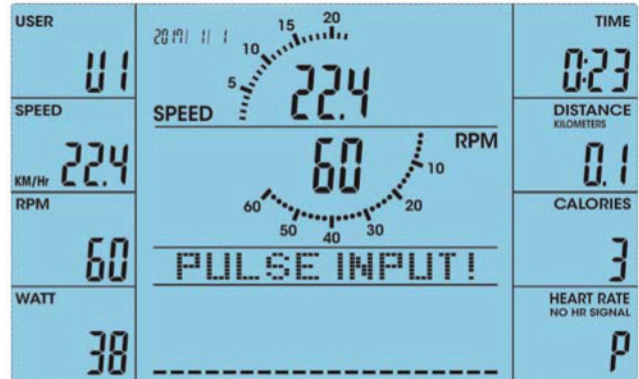

Fig. 43

3.6 Recovery

1. Press RECOVERY after the pure training time and grasp both handles.

All function displays stop except for TIME. It counts down from 00:60 to 00:00 (fig. 44). When the console detects a pulse signal, the LCD screen displays RECOVERY SCANNING. When the console does not detect a pulse signal, the LCD screen reminds of it by displaying PULSE INPUT!

→ The screen displays your recovery pulse status with F1 to F6 (fig. 45). F1 stands for the best value, F6 for the worst.

Continue training to improve your recovery pulse.

2. Press RECOVERY again to return to the main display.

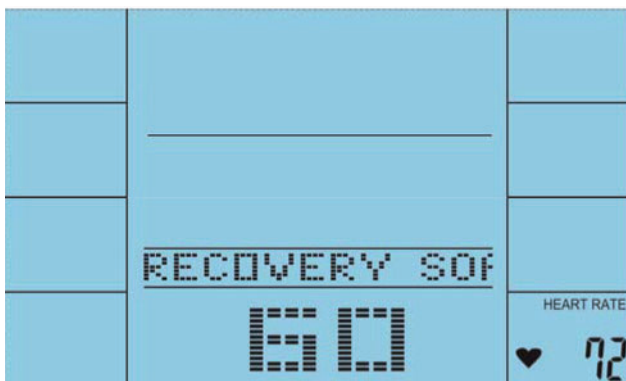

Fig. 44



Fig. 45

3.7 Check or delete saved data

When the machine is turned on, the calendar and the user data U1 to U4 (fig. 46 to 55) have to be entered. Please make sure that the calendar data are correctly entered.

Press START/STOP during the training to stop the display and press SAVE.DELETE.

SAVE FINISH is displayed (fig. 56). The training values are saved now.

The console saves all training values, storages, time, average speed, average RPM, average Watt value, distance, and calories.

When you want to check the data, press the mode selection in the main programme and press RECORDED DATA. Then press UP/DOWN to see the previously saved data (fig. 57).

Check in RECORDED DATA and press SAVE.DELETE. Confirm the deletion of the saving with ENTER (fig. 58).

Delete all data: Press SAVE.DELETE for six seconds in the calendar setting or in the RECORDED DATA control. DELETE ALL! is displayed (fig. 59). Confirm with ENTER. All data are deleted (fig. 60). The computer reboots after 15 seconds and returns to the calendar default 20170101.



Fig. 46



Fig. 47

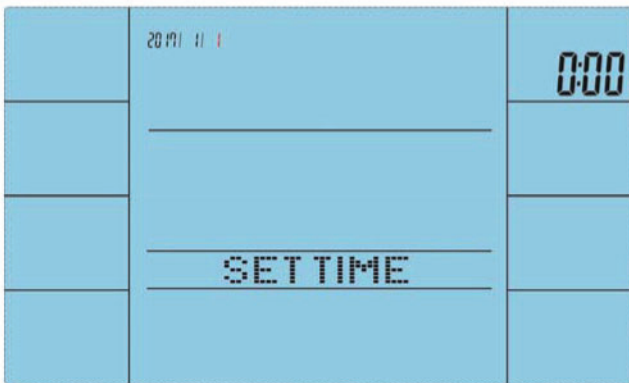

Fig. 48



Fig. 49

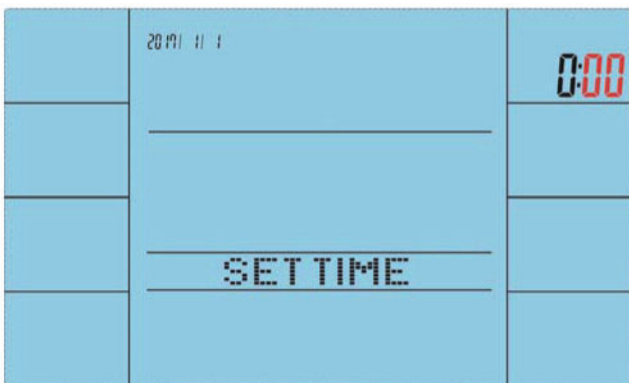

Fig. 50

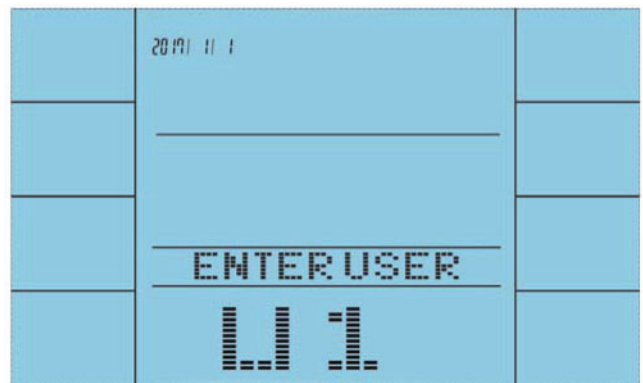

Fig. 51

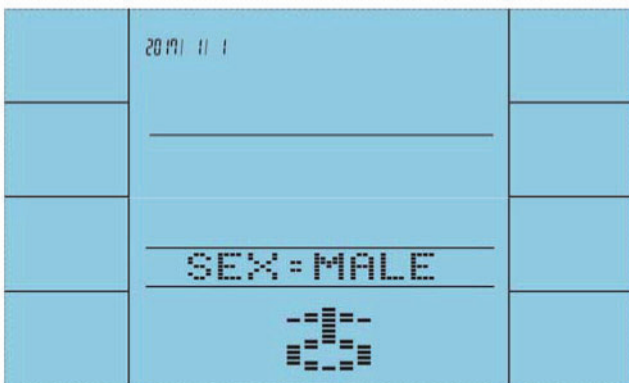

Fig. 52



Fig. 53



Fig. 54



Fig. 55



Fig. 56

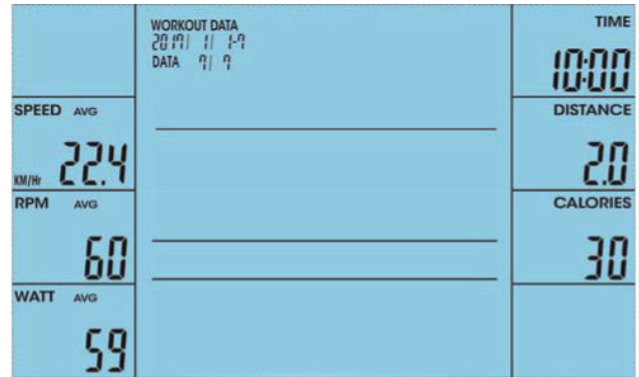

Fig. 57



Fig. 58

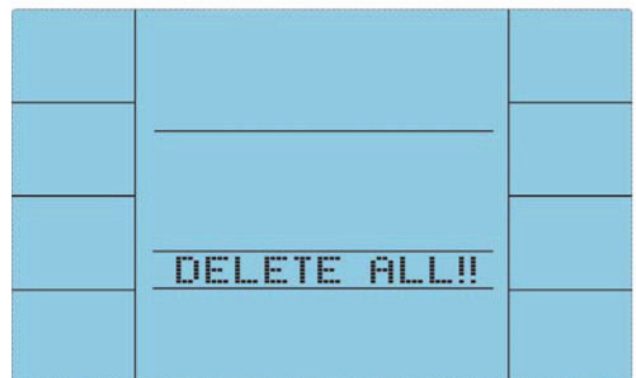

Fig. 59



Fig. 60

3.8 Battery compartment

The battery runs the calendar. If you want to set the calendar, remove the battery and restart the console (fig. 61).



Fig. 61

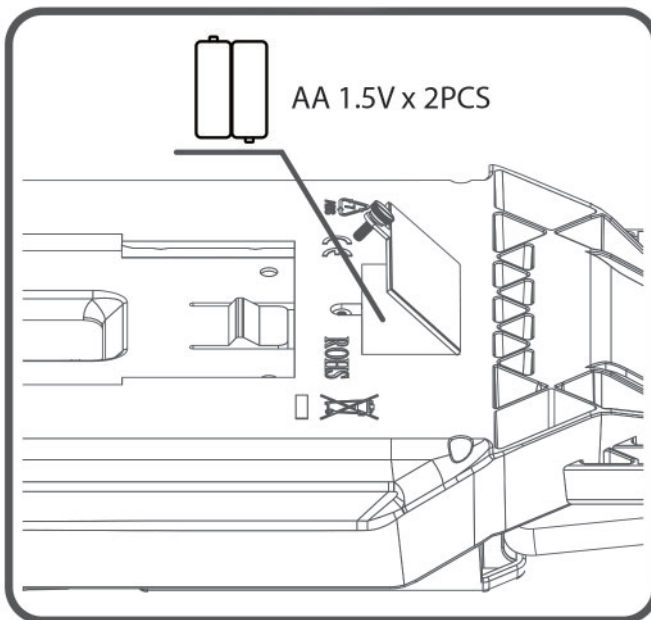

1. Loosen the screw at the battery compartment.
2. Remove the battery compartment coverage.
3. Insert the battery and close the battery compartment by tighten up the screw again.

ⓘ NOTICE

- + If you interrupt the treading for more than four minutes, the computer enters the sleep mode. All entries and training values remain stored till you resume the training.
- + If the computer is not working, please pull the plug and plug it in again.

3.9 Heart-rate measuring

Pulse measuring via hand sensors

The hand sensors integrated in the handles beside the seat allow you to determine your heart rate. You can measure your heart rate by lightly grasping the sensors with both hands at the same time. Blood pressure changes occur due to the heartbeat. The sensors measure the changes to the electric skin resistance caused by it. These values are then used to create an average and are displayed on the screen of the console as a heart rate.

Note:

For some people, the skin resistance change caused by the heart rate is so minimal that the measurements do not allow for usable values. Strong callus or sweat on the hands may also impair a correct measurement. In such cases, the heart rate will not be shown at all or only incorrectly.

If the measurement is incorrect or not taken at all, please check if it happens to only one person or to several people. If the pulse display only does not work in a single case, the equipment is not defective. In this case, we recommend using a chest strap to achieve a permanently correct heart rate display..

CAUTION: Your training equipment is not a medical device. Different factors may influence the accuracy of the heart rate display. The heart rate display only serves as a training aid.

Telemetric heart rate measuring

This recumbent ergometer is already equipped with a heart rate receiver as standard. Using a chest strap makes it possible for you to have a wireless heart rate measuring. This optimal and ECG-precise type of measuring reads the heart rate directly from the skin through a transmitting chest strap. The chest strap then sends the impulse to the receiver integrated in the console.

Positioning the chest strap and moistening the electrodes:

Place the belt directly below the chest, while the transmitter should be placed on the middle of the chest. The chest strap should sit comfortably, but not too loose. If the belt is too loose, the contact to the electrodes may be disrupted or the belt may slip der Brustmitte liegewise exercising. The transmitter turns on automatically once it is put on. In order to allow for a precise measuring, you should moisten the rubber electrodes. This is best done with a special chest strap contact gel, which is also used for ultrasound scans.

Note:

If you have not been active in doing sports for a longer period of time, you should first go to your physician in order to discuss your training with them. You should also contact your physician in advance in the event of heart problems, high/low blood pressure and obesity.

Training with heart rate orientation

Heart rate orientation guarantees an extremely effective and healthy training. Through your age and the following table, you can quickly and easily read and determine the optimal pulse for your training. An acoustic alarm will sound if your heart rate exceeds the set target heart rate. Which target heart rate is important for which training goal can be found out in the following.

Fat burning (weight management): The main goal here is to burn deposits of fat. In order to achieve this training goal, a low training intensity (approximately 55% of the maximum heart rate) and a longer training period are required.

Cardiovascular training (cardio training): The primary goal is to increase stamina and fitness through an improved provision of oxygen through the cardiovascular system. In order to achieve this training goal, medium intensity (approximately 75% of the maximum heart rate) with a medium training period is required.

Anaerobic (maximum) load training: The main goal of maximum load training is to improve recovery after short, intense loads in order to be able to quickly return to the aerobic zone. In order to achieve this training goal, a high intensity (approximately 90% of the maximum heart rate) with short, intense load is required, which is followed by a recovery phase in order to prevent muscle fatigue.

Example:

For a 45-year-old man or woman, the maximum heart rate is 175 ($220 - 45 = 175$).

- The fat burning target zone (55%) is at approximately 96 beats/min.
= $(220 - \text{age}) \times 0.55$.
- The cardio target zone (75%) is at approximately 131 beats/min.
= $(220 - \text{age}) \times 0.75$.
- The maximum heart rate for an anaerobic load training (90%) is at approximately 157 beats/min. = $(220 - \text{age}) \times 0.9$.

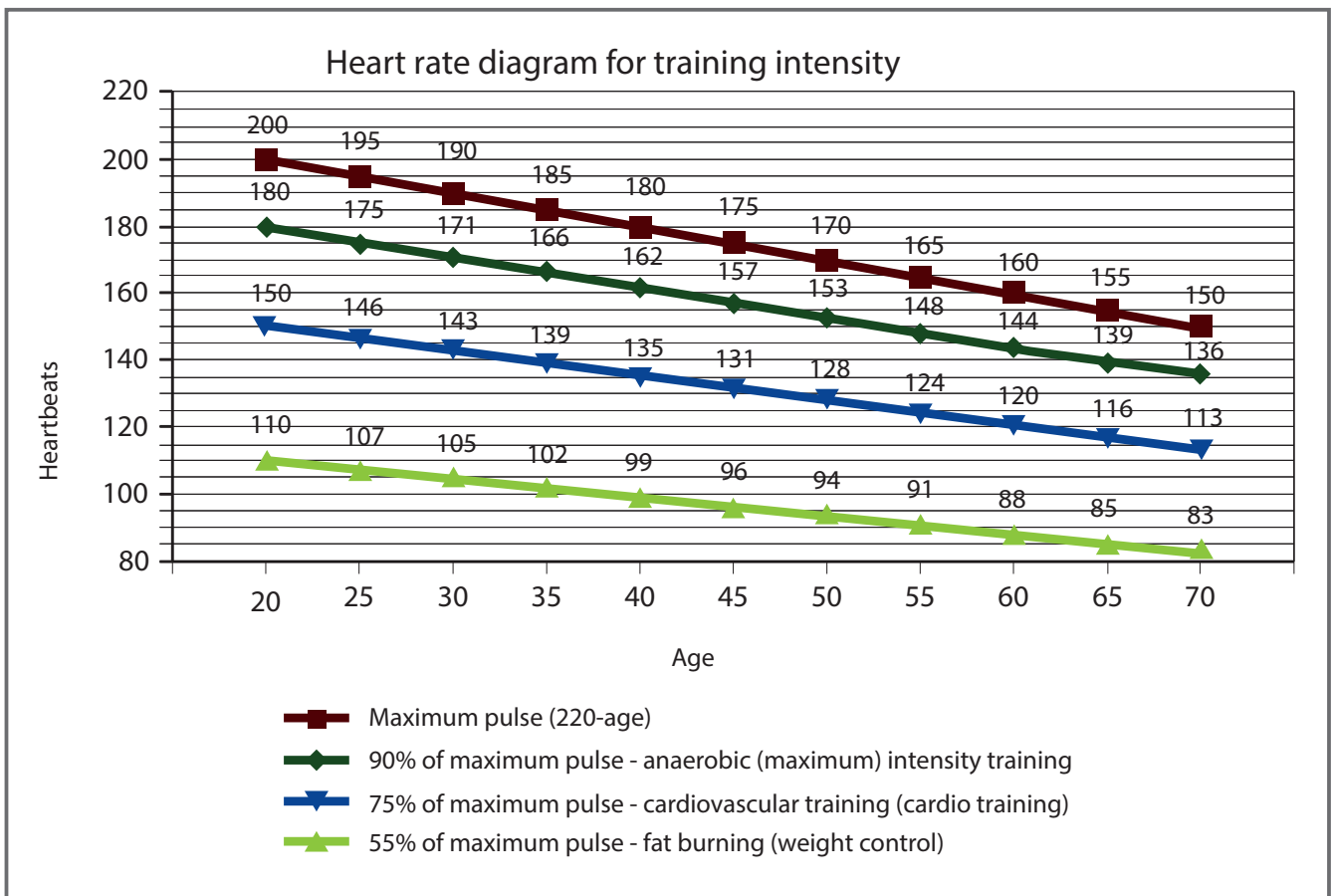

4.1 General Instructions

⚠ WARNING

- + The storage location should be chosen so that improper use by third parties or children can be prevented.
- + If your equipment does not have transportation wheels, the equipment must be disassembled before transportation.

▶ ATTENTION

- + Make sure that the equipment is protected from moisture, dust and dirt in the selected storage location. The storage location should be dry and well ventilated and have a constant ambient temperature between 10°C and 35°C.

4.2 Transportation Wheels

▶ ATTENTION

If you want to transport your equipment over particularly sensitive and soft floor coverings, such as parquet, planks or laminate, lay out the transport route with cardboard or similar to avoid possible floor damage.

1. Stand behind the equipment and lift it until the weight is transferred to the transportation wheels. After that, you easily can move the equipment to a new position. For long transport distances the equipment should be disassembled and safely packed.
2. Select the new location by following the instructions in the section 1.4 of this manual.

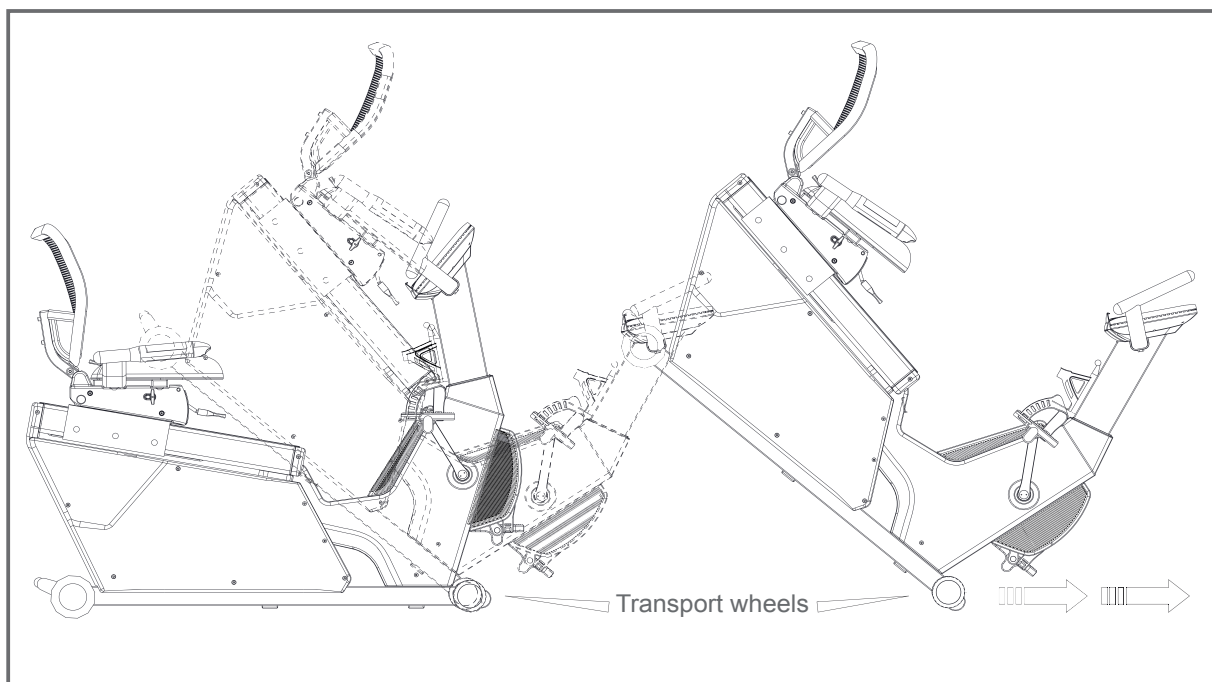

5.1 General Instructions



WARNING

- + Do not make any improper changes to the equipment.



CAUTION

- + Damaged or worn components may affect your safety and the life of the equipment. Therefore, immediately replace damaged or worn components. In such a case, contact the contract partner. The equipment must not be used until it has been repaired. If necessary, use only original spare parts.

ATTENTION

- + In addition to the instructions and recommendations for maintenance and care given here, additional service and/or repair work may be necessary; this must only be carried out by authorised service technicians.

5.2 Faults and Fault Diagnosis

The equipment undergoes regular quality controls during production. Nevertheless, faults or malfunctions may occur. Frequently, individual parts are responsible for these disturbances, an exchange is usually sufficient. Please refer to the following overview for the most common errors and how to correct them. If the equipment still does not function properly, contact your contract partner.

Fault	Cause	Solution
Cracking in the pedal area	Pedals loose	Tighten the pedals
Equipment wobbles	Equipment is not level	Align the feet
Handlebar/saddle wobbles	Loose screws	Tighten screws firmly
Display is blank/is not working	Batteries empty or loose cable connection	Replace batteries or check cable connections
No pulse display	<ul style="list-style-type: none"> + Sources of interference in the room + unsuitable chest strap + Wrong position of chest strap + Chest strap defective or battery empty + Pulse display defective 	<ul style="list-style-type: none"> + Eliminate sources of interference (e.g. mobile phone, WLAN, lawn mower and vacuum cleaner robot, etc. ...) + Use a suitable chest strap (see RECOMMENDED ACCESSORIES) + Reposition chest strap and/or moisten electrodes + Changing batteries + Check if pulse display by hand pulse possible

5.3 Error Codes and Troubleshooting

The electronics of the equipment continuously carries out tests. In case of deviations, an error code appears on the display and normal operation is stopped for your safety.

Please contact the contract partner for technical support.

5.4 Maintenance and Inspection Calendar

To avoid damage from body sweat, the equipment must be cleaned with a damp towel (no solvents!) after each training session.

The following routine tasks must be performed at the specified intervals:

Part	Weekly	Monthly
Display console	C	I
Plastic covers	C	I
Screws and cable connections		I
Check pedals for tightness		I
Legend: C = clean; I = inspect		

By scanning the QR-code with the camera function or QR-code scanner app of your smartphone/tablet, a video on general maintenance of an exercise bike opens on YouTube. The video serves to illustrate the maintenance points described in this manual.



Please note that the video may not be available in your language or with appropriate subtitles.

If you cannot scan QR-codes, you can access all Fitshop videos on YouTube by first opening YouTube and entering "Fitshop" in the search field.

6 DISPOSAL

At the end of its operational life, this equipment cannot be disposed of in normal household waste. Instead, it must be disposed of via an electricals recycling centre. Further information can be obtained from your local authority's recycling service.



The materials can be recycled as per their symbols. Through the reuse, recycling of materials or other forms of recovery of old equipment, you make an important contribution to the protection of the environment.

7 RECOMMENDED ACCESSORIES

To make your training experience even more efficient and pleasant, we recommend that you add suiting accessories to your fitness equipment. For exercise bikes this could for example be a **floor mat**, which makes your fitness equipment stand more securely and also protects the floor from sweat or **silicone spray** to keep moving parts in good shape. For many exercise bikes it is possible to replace the **saddle** or **pedals**, as these are usually the same mounts used on bicycles.

If you have purchased a fitness machine with pulse training and want to train your heart rate, we strongly recommend that you use a compatible **chest strap**, as this ensures optimum transmission of the heart rate.



Our range of accessories offers the highest quality and makes training even better. If you would like to find out more about compatible accessories, please go to the detail page of the product in our webshop (the easiest way is to enter the article number in the search field above) and go to the recommended accessories on this page. Alternatively, you can use the QR-code provided. Of course, you can also contact our customer service: by telephone, e-mail, in one of our branches or via our social media channels. We will be happy to advise you!



saddle cover



chest strap



chest strap contact gel



floor mat



saddle



silicone spray

8.1 Serial Number and Model Name

In order to provide you with the best possible service, please have the model name, article number, serial number, exploded drawing and parts list ready. The corresponding contact options can be found in chapter 10 of this operating manual.

NOTICE

The serial number of your equipment is unique. It's located on a white sticker. The exact position of this sticker is shown in the following illustration.



Enter the serial number in the appropriate field.

Serial number:

Brand / Category:

Model Name:

Article Number:

8.2 Parts List

No.	Qty.	Name	No.	Qty.	Name
IV-A	1	Main Frame	IV-A43	4	Screw (M8 x P1.25 x 40L)
IV-A1	1	Sensor(1100Mm)	IV-A44	2	Aluminum Housing
IV-A2	1	Sensor(1350Mm)	IV-A45	1	Aluminum Track(640L)
IV-A3	1	Motor	IV-A47	2	Aluminum Housing
IV-A5	1	Sensor(950Mm)	IV-A49	4	Screw
IV-A6	1	Screw	IV-A50	8	Screw (M4 x P0.7 x 15L)
IV-A7	1	Sensor Holder	IV-A52	1	Driving Wheel
IV-A11	4	Screw(M5 x 0.8 x 15t)	IV-A53	1	Magnetic
IV-A12	1	Tension Cable	IV-A54	1	Axle
IV-A16	1	Senore Wire(950Mm)	IV-A55	4	Screw (M6 x P1.0 x 15L)
IV-A17	1	Belt (1956L-J6)	IV-A56	2	Bearing (6004zz)
IV-A18	1	Magnetic Whell	IV-A57	2	Pulley Housing
IV-A19	1	Axle	IV-A59	12	Screw (M6 x P1.0 x 12L)
IV-A20	2	Bearing (6003)	IV-A60	2	Nut (M17 x P1.0 x 8t)
IV-A21	1	One Way Bearing	IV-A61	4	Washer
IV-A22	2	Bearing (6001zz)	IV-A62	4	Nut (M6 x P1.0)
IV-A23	1	Pully	IV-A63	2	Nut (M10 x P1.25 x 7t)
IV-A24	4	Screw (M8 x P1.25 x 35L)	IV-A64	2	End Cap
IV-A25	1	Bearing (6001zz)	IV-A65	1	Front Chain Cover(L)
IV-A26	1	C CLIP	IV-A66	1	Front Chain Cover(R)
IV-A27	6	Nut	IV-A67	1	Rear Chain Cover(R)
IV-A29	2	Screw	IV-A68	1	Rear Chain Cover(L)
IV-A30	1	NUT(3/8" X 3t)	IV-A69	15	Screw (M4 x P0.7 x20L)
IV-A31	2	Nut (M6 x P1.0)	IV-A70	1	Crank(L)
IV-A32	2	Steel Shield	IV-A71	1	Crank(R)
IV-A33	1	Magnetic Housing	IV-A72	1	Spring
IV-A34	1	Nut (M6 xP1.0)	IV-B	1	Front Stabilizer
IV-A35	1	Screw (M6 x P1.0 x 65L)	IV-B1	2	End Cap
IV-A37	1	Bush	IV-B2	2	Wheel
IV-A38	2	Washer	IV-B3	4	Screw (M4 x 12L)
IV-A41	1	Strip Of Tracking Housing	IV-C	1	Rear Stabilizer
IV-A42	8	Screw (M5 x P0.8 x 16L)	IV-C1	2	End Cap

IV-D	1	Front Handle Bar	IV-G12	1	Cover Of Seat Tube (R)
IV-D1	4	End Cap	IV-G13	4	Screw (M5 x P0.8 x 10L)
IV-E	1	Central Support Tube	IV-G14	1	Screw (M3 x 15L)
IV-E1	1	Sensor Wire(500Mm)	IV-G15	1	Gas Cylindner
IV-E2	1	Sensor Wire(500Mm)	IV-G16	1	Spring
IV-F	1	Side Handke Bar	IV-G17	1	Screw (M6 x P1.0 x 30L)
IV-F1	3	End Cap (20 x 40mm)	IV-G18	2	Nut (M6 x P1.0)
IV-F2	2	End Cap	IV-G19	2	Bracket
IV-F3	2	End Cap	IV-G20	4	Screw (M8 x P1.25 x 20L)
IV-F4	1	Sensor Wire(L)(650Mm)	IV-G21	4	Washer
IV-F5	1	Sensor Wire(R)(650Mm)	IV-G22	4	Bush
IV-F6	2	End Cap	IV-G23	4	Nut (M8 x P1.25)
IV-F7	2	Sensor Box(Below)	IV-G24	6	Nut (M8 x P1.25)
IV-F8	2	Sensor Box(Above)	IV-G25	12	Washer
IV-F9	2	Screw (M4 x 12L)	IV-G26	6	Bush
IV-F10	1	Control Box(Above)-R	IV-G27	6	Wheel
IV-F10-1	1	Control Box(Below)-R	IV-G28	6	Screw
IV-F11	1	Control Box(Above)-L	IV-G29	2	Screw
IV-F11-1	1	Control Box(Below)-L	IV-G30	1	Moving Basement
IV-F12	1	Mylar Button(R)	IV-G31	1	Sliding Housing (R)
IV-F13	1	Mylar Button (L)	IV-G32	1	Sliding Housing (L)
IV-F14	4	Screw (M3)	IV-G33	4	Washer
IV-F15	4	Nut (M3)	IV-G34	4	Screw (M6 x P1.0 x 10L)
IV-F16	4	Sensor Sheet Metal	IV-G35	1	Screw (M6 x P1.0 x 30L)
IV-G	1	Back Pad Support Tube	IV-G36	1	Washer
IV-G1	1	End Cap (25 x 50mm)	IV-G37	1	Nut (M6 x P1.0)
IV-G2	1	Saddle Basement	IV-G38	2	Screw (M5 x P0.8 x 8L)
IV-G3	1	Rotate Reciprocator	IV-G39	1	Bush
IV-G4	1	Screw (M6 x 1.0 x 12L)	IV-G40	2	Washer
IV-G5	1	Axle	IV-G41	1	Axle
IV-G6	1	Nut	IV-G42	2	Washer
IV-G7	2	Nut (M8 x P1.25)	IV-G43	1	Spring
IV-G8	2	Washer	IV-G44	1	Rotate Shaft
IV-G10	1	Axle	IV-G45	1	Screw (M8 x P1.25 x 45L)
IV-G11	1	Cover Of Seat Tube (L)	IV-G46	1	Bush

IV-G47	1	Nut (M8 x P1.25)	IV-N14	2	Screw M5x5L
IV-G47-1	1	Washer	IV-N15	4	Spring Washer M8
IV-G48	1	Screw (M6 x P1.0 x20L)	IV-N16	3	Screw M8x30
IV-G49	1	Nut (M6 x P1.0)	IV-P8	1	U-shaped Base
IV-G50	1	Axle Grip	IV-P10	2	Washer $\Phi 27 \times \Phi 13 \times 3.0T$
IV-G51	1	Adjusting Axle	IV-P11	2	Nut M12x8.0T
IV-G52	2	Screw (M6 x P1.0 x15L)	IV-P12	1	Screw M10x50L
IV-G53	2	Washer	IV-P13	1	Nut M10
IV-G54	2	Bush	IV-P14	1	Guide Wheel Frame
IV-H	1	Console	IV-P15	2	Sleeve $\Phi 16 \times \Phi 10 \times 10mm$
IV-H1	4	Screw	IV-P16	2	Bushing
IV-J	1	Bottle Holder			
IV-K	1	Saddle			
IV-L	1	Back Pad			
IV-M1	1	Pedal(L)			
IV-M2	1	Pedal(R)			
IV-M3	1	Central Supporting Tube Cover (L)			
IV-M4	1	Central Supporting Tube Cover (R)			
IV-M5	1	Bar			
IV-M6	1	Adaptor			
IV-M7	2	Pedal Belt			
IV-N1	2	Screw M8x100			
IV-N2	15	Washer M8x16			
IV-N3	2	Screw M8x20			
IV-N4	4	Screw M8x15			
IV-N6	1	Screw M4x20			
IV-N7	4	Screw 1/4X37			
IV-N9	2	Nut M8			
IV-N10	4	Screw M8x30			
IV-N11	3	Adjust Handle			
IV-N12	4	Screw M8x15			
IV-N13	1	Screw M8x10			
IV-N13-1	1	Screw M8x10			

8.3 Exploded Drawing

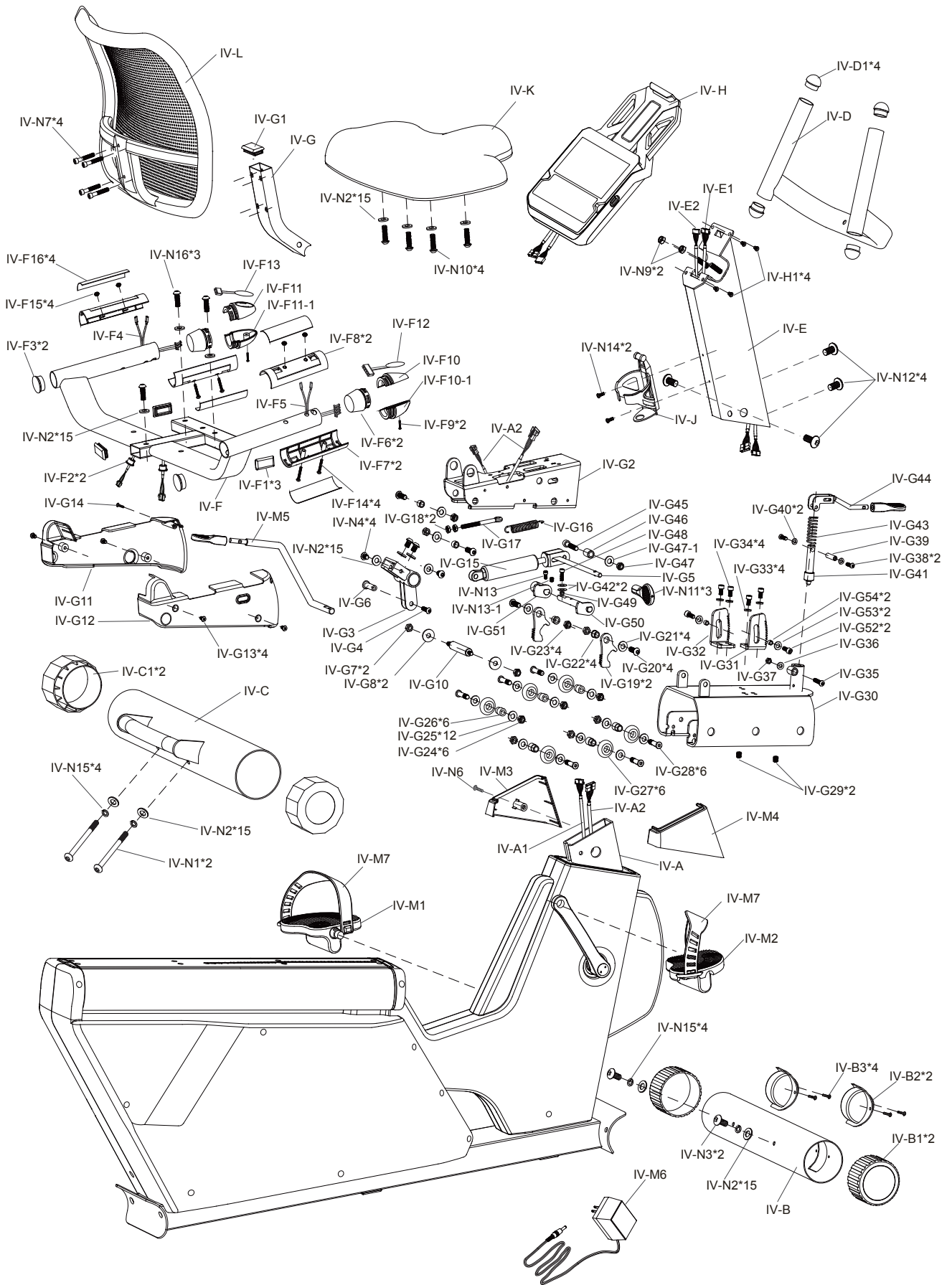

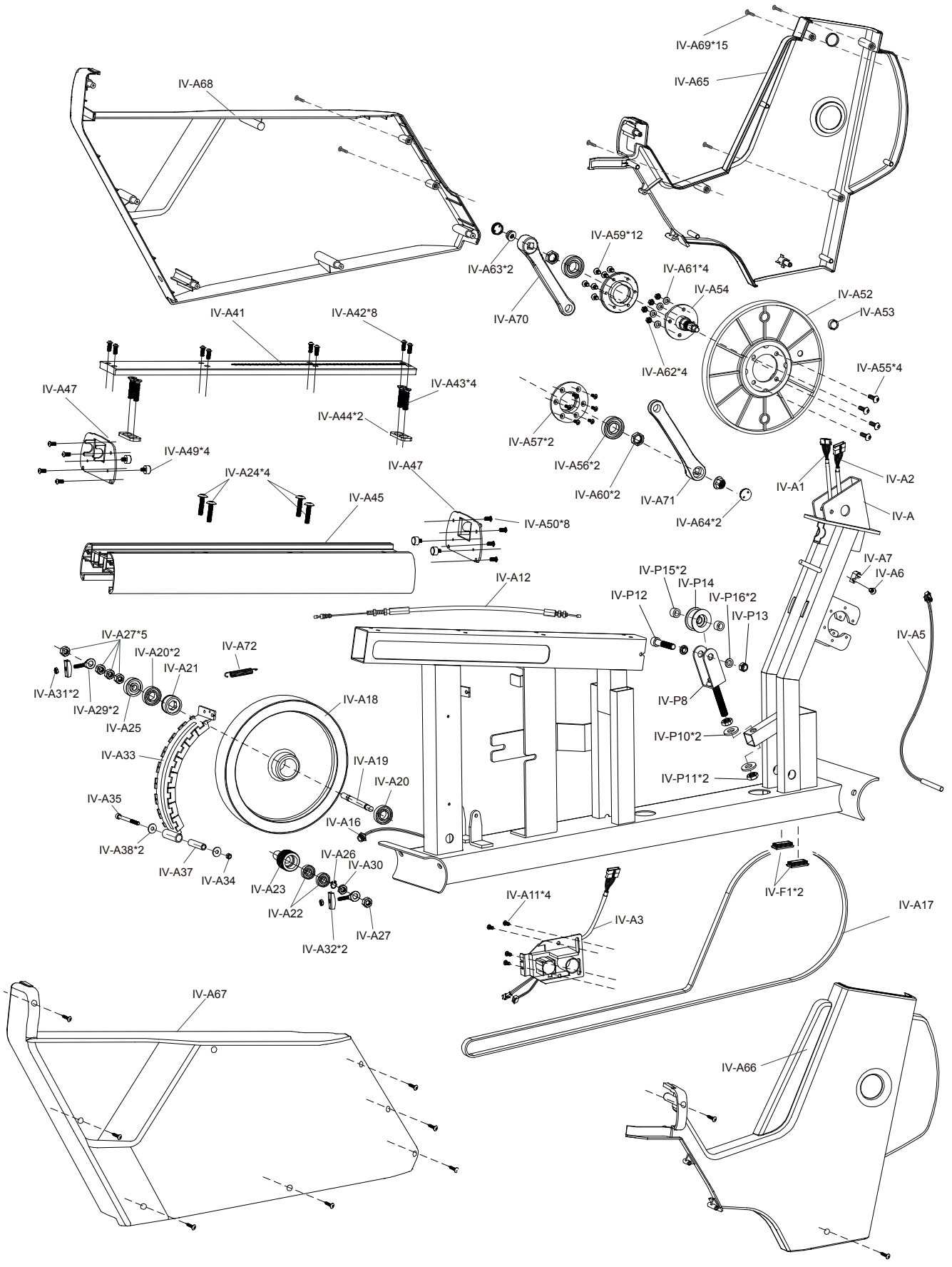

Products from cardiostrong® are subject to strict quality control. However, if a fitness equipment purchased from us does not work perfectly, we take it very seriously and ask you to contact our customer service as indicated. We are happy to help you by phone via our service hotline.

Error Descriptions

Your fitness equipment is developed for long-term, high-quality training. However, should a problem arise, please first read the operating instructions. For further assistance, please contact your contract partner or call our service hotline. To ensure your problem is solved as quickly as possible, please describe the defect as exactly as possible.

In addition to the statutory warranty, we provide a warranty for every fitness equipment purchased from us according to the following provisions.

Your statutory rights are not affected.

Warrantee

The warrantee is the first/original buyer and/or any person who received a newly purchased product as a gift from the original buyer.

Warranty period

The warranty periods, shown on our web shop, begin on delivery of the fitness equipment. The respective warranty periods for your equipment can be found on its product website.

Repair Costs

According to our choice, there will either be a repair, a replacement of individual damaged parts or a complete replacement. Spare parts, that have to be mounted while assembling the equipment, have to be replaced by the warrantee personally and are not a part of repair. After the expiration of the warranty period, the responsibility for parts costs, repair costs, installation costs and delivery costs lies with the warranty holder.

The terms of use are defined as follows:

- + Home use: solely for private use in private households up to 3 hours per day
- + Semi-professional use: up to 6 hours per day (e. g. rehabilitation centres, hotels, clubs, company gyms)
- + Professional use: more than 6 hours per day (e. g. commercial gyms)

Warranty Service

Within the warranty period, equipment which develops faults as a result of material or manufacturing defects, will be repaired or replaced at our discretion. Ownership of equipment or parts of equipment which have been replaced is transferred to us. The warranty period is not extended nor does a new warranty period begin following repair or replacement under the warranty.

Warranty Conditions

For the warranty to be valid, the following steps must be taken:

Please contact our customer service by email or phone. If the product under warranty has to be sent in for repair, the seller bears costs. After expiry of the warranty, the buyer bears the costs of transport and insurance. If the fault is covered by our warranty, you will receive a new or repaired equipment in return.

Warranty claims are invalid in case of damage resulting from:

- + misuse or improper handling
- + environmental influences (moisture, heat, electrical surge, dust, etc.)
- + failure to follow the current safety measures for the equipment
- + failure to follow the operating instructions
- + use of force (e. g. hitting, kicking, falling)
- + interventions which were not carried out by one of our authorized service centres
- + unauthorised repair attempts

Proof of Purchase and Serial Number

Please make sure that you are able to provide the appropriate receipt when claiming on your warranty. So that we can clearly identify the model of your equipment, and for the purposes of our quality control, you will need to give the serial number of your equipment, when contacting the service team. Where possible please have your serial number and your customer number ready when you call our service hotline. It will help us to deal with your request swiftly.







































If you cannot find the serial number on your fitness equipment, our service team is at your disposal to offer further information.

Service outside of the Warranty Period

We are also happy to issue an individual cost estimate if there is a problem with your fitness equipment after the warranty has expired, or in cases which do not fall under the terms of the warranty, e. g. normal wear and tear. Please contact our customer service team to find a quick and cost-effective solution to your problem. In such a case you will be responsible for the delivery costs.

Communication

Many problems can be solved just by speaking to us as your specialist supplier. We know how important it is to you as a user of the fitness equipment to have problems solved quickly and simply, so you can enjoy working out with minimal interruption. For that reason, we also want to resolve your queries quickly and in a straightforward manner. Thus, please always keep your customer number and the serial number of the faulty equipment handy.

DE	DK	UK
<p>TECHNIK</p> <p> +49 4621 4210-900</p> <p> +49 4621 4210-698</p> <p> technik@fitshop.de</p> <p> Öffnungszeiten entnehmen Sie unserer Homepage.</p>	<p>TEKNIK OG SERVICE</p> <p> 80 90 16 50</p> <p>+49 4621 4210-945</p> <p> info@fitshop.dk</p> <p> Åbningstider kan findes på hjemmesiden: https://stg.fit/statit7</p>	<p>CUSTOMER SUPPORT</p> <p> 00800 2020 2772</p> <p>+494621 4210 944</p> <p> info@fitshop.co.uk</p> <p> You can find the opening hours on our homepage: https://stg.fit/statitc</p>
<p>SERVICE</p> <p> 0800 20 20277 (kostenlos)</p> <p> 04621 4210 - 0</p> <p> info@fitshop.de</p> <p> Öffnungszeiten entnehmen Sie unserer Homepage: https://stg.fit/statita</p>	<p>FR</p> <p>TECHNIQUE & SERVICE</p> <p> +33 (0) 189 530984</p> <p>+49 4621 42 10 933</p> <p> info@fitshop.fr</p> <p> Vous trouverez les heures d'ouverture sur notre site Internet: https://stg.fit/statit4</p>	<p>BE</p> <p>TECHNIQUE & SERVICE</p> <p> 02 732 46 77</p> <p>+49 4621 4210 933</p> <p> info@fitshop.be</p> <p> Vous trouverez les heures d'ouverture sur notre site Internet: https://stg.fit/statit8</p>
<p>ES</p> <p>TECNOLOGÍA Y SERVICIOS</p> <p> 911 238 029</p> <p> info@fitshop.es</p> <p> Consulta nuestro horario de apertura en la página web: https://stg.fit/statit5</p>	<p>NL</p> <p>TECHNISCHE DIENST & SERVICE</p> <p> +31 172 619961</p> <p> service@fitshop.nl</p> <p> De openingstijden vindt u op onze homepage: https://stg.fit/statit3</p>	<p>INT</p> <p>TECHNICAL SUPPORT & SERVICE</p> <p> +49 4621 4210-944</p> <p> service-int@fitshop.de</p> <p> You can find the opening hours on our homepage: https://stg.fit/statita</p>
<p>PL</p> <p>DZIAŁ TECHNICZNY I SERWIS</p> <p> 22 307 43 21</p> <p>+49 4621 42 10-948</p> <p> info@fitshop.pl</p> <p> Godziny otwarcia można znaleźć na stronie głównej: https://stg.fit/statit6</p>	<p>AT</p> <p>TECHNIK & SERVICE</p> <p> 0800 20 20277 (Freecall)</p> <p>+49 4621 42 10-0</p> <p> info@fitshop.at</p> <p> Öffnungszeiten entnehmen Sie unserer Homepage: https://stg.fit/statitb</p>	<p>CH</p> <p>TECHNIK & SERVICE</p> <p> 0800 202 027</p> <p>+49 4621 42 10-0</p> <p> info@fitshop.ch</p> <p> Öffnungszeiten entnehmen Sie unserer Homepage: https://stg.fit/statit9</p>

Please find a detailed overview including address and opening hours for all stores of the Fitshop Group in Germany and abroad on the following website:

www.fitshop.com/en/stores

WE LIVE FITNESS

WEBSHOP AND SOCIAL MEDIA

Fitshop is Europe's largest specialist store for home fitness equipment with currently over 70 stores and one of the world's most renowned online mail order companies for fitness equipment. Private customers order via the 25 web shops in the respective national language or have their desired equipment assembled on site. In addition, the company supplies fitness studios, hotels, sports clubs, companies and physio practices with professional equipment for endurance and strength training.

Fitshop offers a wide range of fitness equipment from renowned manufacturers, high-quality in-house developments and comprehensive services, such as a build-up service and sports scientific advice before and after the purchase. The company employs numerous sports scientists, fitness trainers and competitive athletes.

Visit us also on our social media platforms or our blog!

	www.fitshop.co.uk www.fitshop.de/blog
---	--

	www.facebook.com/fitshop.co.uk
---	--

	www.instagram.com/fitshop_uk
--	--

	www.youtube.com/@fitshop_uk
---	--

TAURUS

 cardiostrong 

BODYCRAFT

 cardiojump

 **DUKEFITNESS**

DARWIN

Notes

