



## Assembly and Operating Instructions



max. 150 kg



~ 30-60 Min.



47 kg

L 96 | W 56 | H 143

FSCSTBX70i.02.02

Art. No. CST-BX70i-2

Ergometer **BX70i**



# Content

<b>1</b>	<b>GENERAL INFORMATION</b>	<b>8</b>
1.1	Technical Data	8
1.2	Personal Safety	9
1.3	Electrical Safety	10
1.4	Set-Up Place	11
<b>2</b>	<b>ASSEMBLY</b>	<b>12</b>
2.1	General Instructions	12
2.2	Scope of Delivery	13
2.3	Assembly	15
<b>3</b>	<b>OPERATING INSTRUCTIONS</b>	<b>21</b>
3.1	Console display	21
3.2	Button Function	23
3.3	Turning On and Setting the Equipment	23
3.4	Training programme	24
3.4.1	MANUAL MODE	24
3.4.2	PROGRAM MODE	25
3.4.3	H.R.C. MODE	26
3.4.4	WATT MODE	27
3.4.5	USER PROGRAM MODE	27
3.4.6	RECOVERY	28
3.4.7	BODY FAT	28
3.5	Connection with Kinomap	30
<b>4</b>	<b>STORAGE AND TRANSPORT</b>	<b>32</b>
4.1	General Instructions	32
4.2	Transportation Wheels	32
<b>5</b>	<b>TROUBLESHOOTING, CARE AND MAINTENANCE</b>	<b>33</b>
5.1	General Instructions	33
5.2	Faults and Fault Diagnosis	33
5.3	Error Codes and Troubleshooting	34
5.4	Maintenance and Inspection Calendar	34
<b>6</b>	<b>DISPOSAL</b>	<b>35</b>
<b>7</b>	<b>RECOMMENDED ACCESSORIES</b>	<b>36</b>

<b>8</b>	<b>ORDERING SPARE PARTS</b>	<b>37</b>
8.1	Serial Number and Model Name	37
8.2	Parts List	38
8.3	Exploded Drawing	41
<b>9</b>	<b>WARRANTY</b>	<b>42</b>
<b>10</b>	<b>CONTACT</b>	<b>44</b>

**Dear customer,**

thank you for choosing fitness equipment from cardiostrong®. cardiostrong offers high-quality home fitness equipment that is optimally adapted to the conditions at home. Train at home no matter what the weather or time of the day. cardiostrong fitness equipment offers training programmes and a variety of equipment for all training levels and all training goals.

Further information can be found at [www.fitshop.co.uk](http://www.fitshop.co.uk) or [www.cardiostrong.de](http://www.cardiostrong.de).

We hope you enjoy your training!

#### **Intended Use**

The equipment may only be used for its intended purpose.

The equipment is suitable for home use and semi-professional use (e.g. hospitals, clubs, hotels, schools, etc.). The equipment is not suitable for commercial or professional use (e.g. fitness studio).

#### **Legal Notice**

Fitshop GmbH  
Europe's No. 1 for home fitness

International Headquarters  
Flensburger Straße 55  
24837 Schleswig  
Germany

Management:  
Christian Grau  
Sebastian Campmann  
Dr. Bernhard Schenkel  
No. HRB 1000 SL  
Local Court Flensburg  
European VAT Number: DE813211547

#### **Disclaimer**

© cardiostrong is a registered brand of the company Fitshop GmbH. All rights reserved. Any use of this trademark without the explicit written permission of Fitshop is prohibited.

Product and manual are subject to change. Technical data can be changed without advance notice.

# **FITSHOP**

Europe's No.1 for Home Fitness

## ABOUT THIS MANUAL

Please carefully read the entire manual before installation and first use. The manual will help you to quickly set up the system and explains how to safely use it. Make sure that all persons exercising with the equipment (especially children and persons with physical, sensory, mental or motor disabilities) are informed about this manual and its contents in advance. In case of doubt, responsible persons must supervise the use of the equipment.

Due to ongoing changes and software optimisations, the manual may have to be updated. If you notice any discrepancies during assembly or use, please refer to the manual uploaded to the webshop. The latest manual is always available there.



This equipment has been manufactured according to the latest safety knowledge. As far as possible, potential safety hazards which could cause injury have been eliminated. Make sure to carefully follow the instructions and that all parts are securely in place. If required, read through the instructions again to correct any mistakes.

Training devices must be classified according to accuracy and use. Accuracy classes are only applicable to devices that display training data.

### Accuracy classes

Class A: high accuracy.

Class B: medium accuracy.

Class C: low accuracy.

The use classes explain the intended use of the training device.

### Use classes

**Class S** (studio): professional and/or commercial use.

These training devices are intended for the use in training rooms of facilities such as sports clubs, school facilities, hotels, clubs and studios whose access and supervision is specifically regulated by the owner (person with legal responsibility).

**Class H** (home use): use at home.

These stationary training devices are intended for the use in private homes where access to the training device is regulated by the owner (person with legal responsibility).

Please pay close attention to the safety and maintenance instructions given here. The contract partner cannot be held liable for damage to health, accidents or damage to the equipment when it is not used in accordance with these instructions.

The following safety instructions may appear in this manual:

► **ATTENTION**

This notice indicates potentially hazardous situations which, if not avoided, may result in property damage.

⚠ **CAUTION**

This notice indicates potentially hazardous situations which, if not avoided, may result in slight or minor injuries!

⚠ **WARNING**

This notice indicates potentially hazardous situations which, if not avoided, may result in death or serious injuries!

⚠ **DANGER**

This notice indicates potentially hazardous situations which, if not avoided, will result in death or serious injuries!

ⓘ **NOTICE**

This notice indicates further useful information.

Retain these instructions in a safe place for future reference, maintenance or when ordering replacement parts.

## 1.1 Technical Data

### LED display of

- + speed in km/h
- + training time in min
- + training distance in km
- + cadence (rotations per minute)
- + calories burnt
- + heart rate (when using the hand sensors or a chest strap)
- + watt
- + resistance level

Resistance system:	electromagnetic induction brake
Resistance level:	32
Watt:	10 - 350 Watt (adjustable in 5-watt increments)

Total number of training programs:	18
Manual programs:	1
Pre-set programs:	12
Watt-controlled programs:	1
Heart rate controlled programs:	1
User defined programs:	1

Flywheel mass:	10 kg
Transmission:	1 : 8.1
Pedal arm length:	17 cm

### Weight and dimensions

Article weight (gross, including packaging):	50.8 kg
Article weight (net, without packaging):	46.6 kg

Packaging dimensions (L x W x H):	approximately 102 cm x 28 cm x 68 cm
Set-up dimensions (L x W x H):	approximately 96 cm x 56cm x 143 cm
Maximum user weight:	150 kg/330 lbs
Use class:	S



## 1.2 Personal Safety

### **DANGER**

- + Before you start using the equipment, you should consult your physician that this type of exercise is suitable for you from a health perspective. Particularly affected are persons who: have a hereditary disposition to high blood pressure or heart disease, are over the age of 45, smoke, have high cholesterol values, are overweight and/or have not exercised regularly in the past year. If you are under medical treatment that affects your heart rate, medical advice is absolutely essential.
- + Note that excessive training can seriously endanger your health. Please also note that heart rate monitoring systems can be inaccurate. If you notice any signs of weakness, nausea, dizziness, pain, shortness of breath, or other abnormal symptoms, stop exercising immediately and seek advice from your doctor if necessary.
- + The owner must communicate all warnings and instructions to the user.

### **WARNING**

- + This equipment may not be used by children under the age of 14.
- + Children should not be allowed unsupervised access to the equipment.
- + Persons with disabilities must have a medical license and must be under strict observation when using the equipment.
- + The equipment is strictly for use by one person at a time.
- + If your equipment provides a safety key, the clip of the safety key must be attached to your clothing before starting your training. In the event of a fall, the EMERGENCY STOP of the equipment can be initiated.
- + There is a risk of injury from spinning pedals and/or an exposed flywheel in the absence of a freewheel. Never get on or off the equipment when the pedals or the flywheel are still moving. Always make sure that the pedals and the flywheel have come to a complete stop.
- + Support yourself with at least one hand on the handlebar when getting on and off the equipment. Only dismount from the equipment when the pedals have come to a complete stop.
- + Keep your hands, feet and other body parts, hair, clothing, jewellery and other objects well clear of moving parts.
- + During use, wear suitable sports clothing rather than loose or baggy clothing. When wearing sports shoes, make sure they have suitable soles, preferably made of rubber or other non-slip materials. Shoes with heels, leather soles, studs or spikes are unsuitable. Never exercise barefoot.

### **CAUTION**

- + If your equipment needs to be connected to the power supply with a mains cable, make sure that the cable is not a potential tripping hazard.
- + Make sure that nobody is within the range of motion of the equipment during training so as not to endanger you or other persons.
- + Always tighten the pedal strap before you start training to prevent your feet from slipping.

**⚠ CAUTION**

- + Be aware that if adjustment devices are left protruding, they may impede the user's movement.

**▶ ATTENTION**

- + Do not insert any objects of any kind into the openings of the device.
- + To protect the equipment from use by unauthorised third parties, always remove the power cable when not in use and store it in a safe place that is inaccessible to unauthorised persons (e.g. children).
- + Class B and C crank training equipment is not suitable for high accuracy purposes.

## 1.3 Electrical Safety

**⚠ DANGER**

- + In order to reduce the risk of an electric shock, always unplug the equipment from the mains socket immediately after your workout, before assembly or dismantling, and before maintenance or cleaning. Do not pull on the cable.

**⚠ WARNING**

- + Do not leave the equipment unattended while the mains cable is plugged into the mains socket. During your absence, the mains cable must be removed from the mains socket to prevent improper use by third parties or children.
- + If the mains cable or plug is damaged or defective, contact your contract partner. Until repair, the equipment must not be used.

**▶ ATTENTION**

- + The equipment requires a mains connection of 220-230 V with 50 Hz mains voltage.
- + The equipment may only be connected directly to an earthed socket using the supplied mains cable. Extension cables must conform to VDE guidelines. Always completely unwind the mains cable.
- + The socket must be protected by a fuse with a minimum fuse rating of "16 A, slow blow".
- + Do not make any changes to the mains cable or the mains plug.
- + Keep the mains cable away from water, heat, oil and sharp edges. Do not route the mains cable underneath the equipment or under a carpet or rug, and do not place any objects on top of it.
- + If your purchased item is equipped with a TFT console, software updates must be carried out regularly. Follow the instructions on the console to perform the update(s).
- + The software systems on gym equipment with TFT consoles are set up only for the pre-installed apps. Do not install any additional apps.

**ⓘ NOTICE**

- + The pre-installed apps on TFT consoles are produced and provided by external manufacturers. Fitshop does not take any responsibility for the availability, functionality or contents of these apps.

## 1.4 Set-Up Place

### **WARNING**

- + Do not place the equipment in main corridors or escape routes.

### **CAUTION**

- + Choose a location in which to place the equipment such that there is enough free space/clearance to the front, the rear and to the sides of the equipment.
- + The training room should be well ventilated during training and not be exposed to any draughts.
- + Choose the place in which to set up the equipment such that there is enough free space/clearance to the front, the rear and to the sides of the equipment.
- + The free area in the direction from which the exercise equipment is accessed must be at least 0.6 m larger than the exercise area.
- + The set-up and mounting surface of the equipment should be flat, loadable and solid.

### **ATTENTION**

- + The device may only be used in one building, in sufficiently tempered and dry rooms (ambient temperatures between 10°C and 35°C). The equipment should not be used outdoors or in rooms with high humidity (over 70%) like swimming pools.
- + A floor protective mat/equipment underlay can help to protect high-quality floor coverings (parquet, laminate, cork, carpets) from dents and sweat and can help to level out slight unevenness.
- + For Class S equipment, the exercise equipment may only be used in areas where access, supervision and control are specifically regulated by the owner.

### 2.1 General Instructions



#### **DANGER**

- + Do not leave any tools, packaging materials such as foils or small parts lying around, as otherwise there is a danger of suffocation for children. Keep children away from the equipment during assembly.



#### **WARNING**

- + Pay attention to the instructions attached to the equipment in order to reduce the risk of injuries.



#### **CAUTION**

- + Ensure to have sufficient room for movement in each direction during assembly.
- + The assembly of the equipment must be carried out by at least two adults. If in doubt, seek the help of a third technically skilled person.



#### **ATTENTION**

- + To prevent damage to the equipment and the floor, assemble the equipment on a mat or packaging board.



#### **NOTICE**

- + In order to make the assembly as simple as possible, some screws and nuts to be used can already be pre-assembled.
- + Ideally, assemble the equipment at its later set-up place.

## 2.2 Scope of Delivery

The scope of delivery consist of the following parts. At the beginning, check whether all parts and tools belonging to the device are included in the scope of delivery and whether damage has occurred. In the event of complaints, the contractual partner must be contacted directly.

### ⚠ CAUTION

If parts of the scope of delivery are missing or damaged, the assembly must not be carried out.

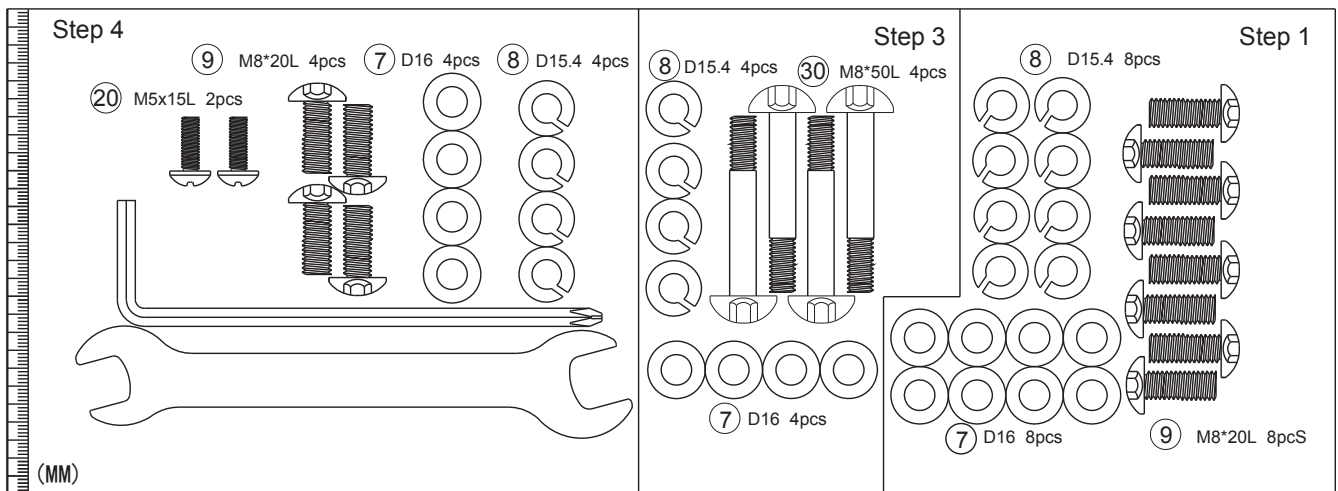

<p>①</p>  <p>x1</p>	<p>④⑦</p>  <p>x1</p>	<p>②⑧</p>  <p>x1</p>
	<p>①⑦</p>  <p>x1</p>	<p>⑥⑤</p>  <p>x1</p>
<p>②⑨</p>  <p>x1</p>	<p>⑥⑥</p>  <p>x1</p>	<p>③②</p>  <p>x1</p>
<p>④</p>  <p>x1</p>	<p>②③</p>  <p>x2</p>	<p>⑩&amp;①①</p>  <p>x1</p>
	<p>⑥②&amp;⑧⑧</p>  <p>x1</p>	<p>①⑤</p>  <p>x1</p>
	<p>②</p>  <p>x1</p>	<p>⑧①</p>  <p>x1</p>

## 2.3 Assembly

Before assembly, take a close look at the individual assembly steps shown and carry out the assembly in the order given.

### ① NOTICE

- + First loosely screw all parts together and check that they fit properly. Tighten the screws using the tool only when you are instructed to do so.
- + If you have difficulty recognising the graphics, we recommend that you open and/or download the PDF instructions stored in the webshop on your end device (e.g. smartphone, tablet or PC). There you have the option of zooming in closer. Please note that the Adobe Acrobat Reader programme must be installed on your end device in order to open the file.
- + The assembly can also be found as a video under the following link: <https://www.sport-tiedje.co.uk/cardiostrong-exercise-bike-bx70i-cst-bx70i-2#product-assembly>. To go directly to the assembly video, you can alternatively scan the QR-code.



### Step 1: Assembly of the bases

1. Mount the front base (4) and the rear base (2) on the main frame (1) with the help of the spacer sleeve (7), spring washer (8) and socket screw (9).
2. Turn the wheel under the foot cap in order to set the corresponding height. Tighten the screws. Mount the cover for wheel (23).

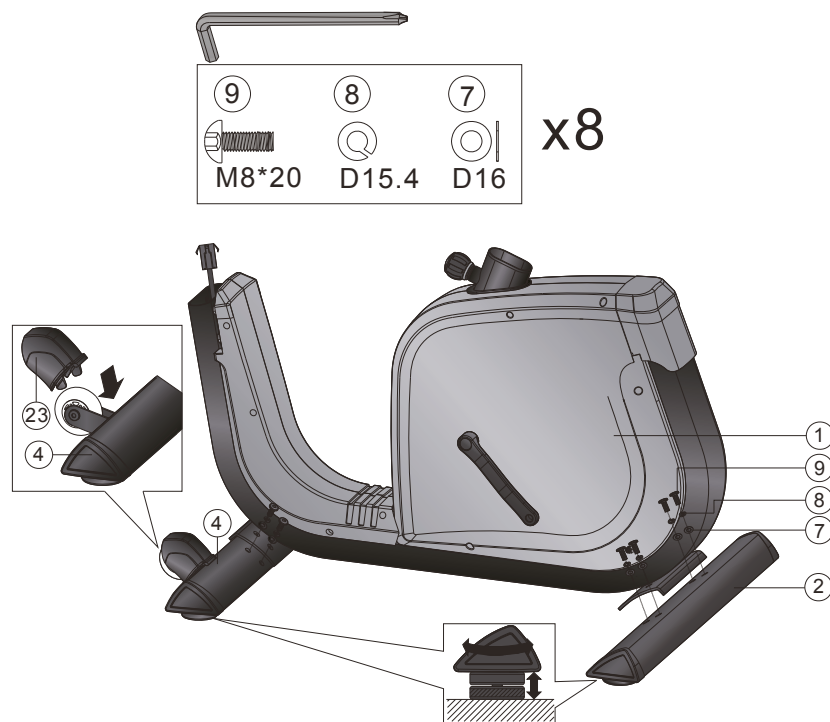

## Step 2: Assembly of the saddle and seat tube

1. Mount the seat (10) on the adjusting tube of the seat (11).
2. Mount the adjusting tube on the seat post (66) with the help of the round cross screw (16) and quick-released knob (15).
3. The seat can be adjusted in a vertical and horizontal direction, see figure a. and b.

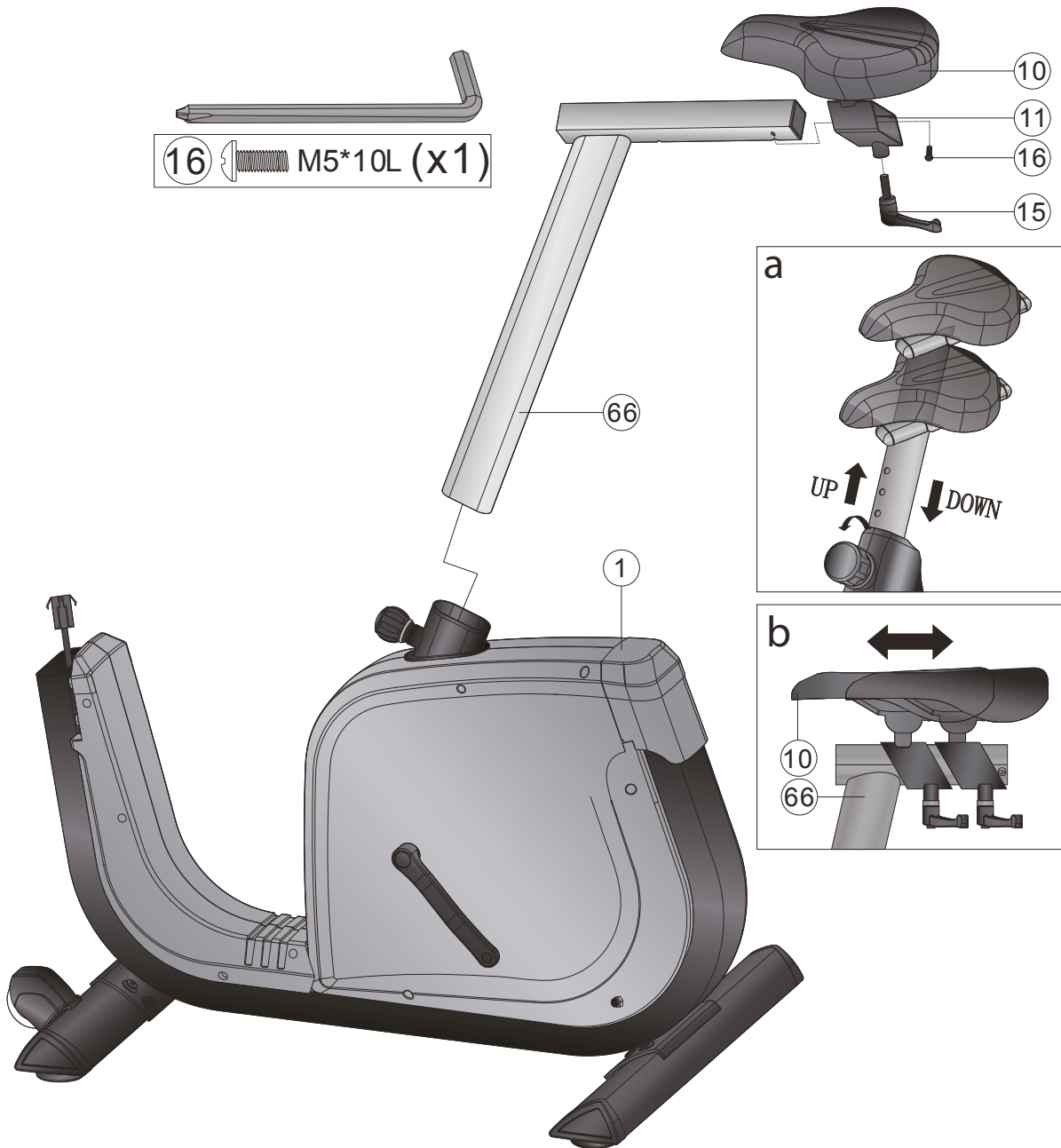



### Step 3: Assembly of the handlebar tube

1. This assembly step should be executed by at least two persons.
2. First take the upper protective cover (28) off (see figure a). Then connect the computer cables (72 & 73) (see figure b).
3. Insert the handlebar tube (29) on the main frame and mount this with the spacer sleeve (7), spring washer (8) and socket screw (30). Place the upper protective cover back on and mount it on the main frame.

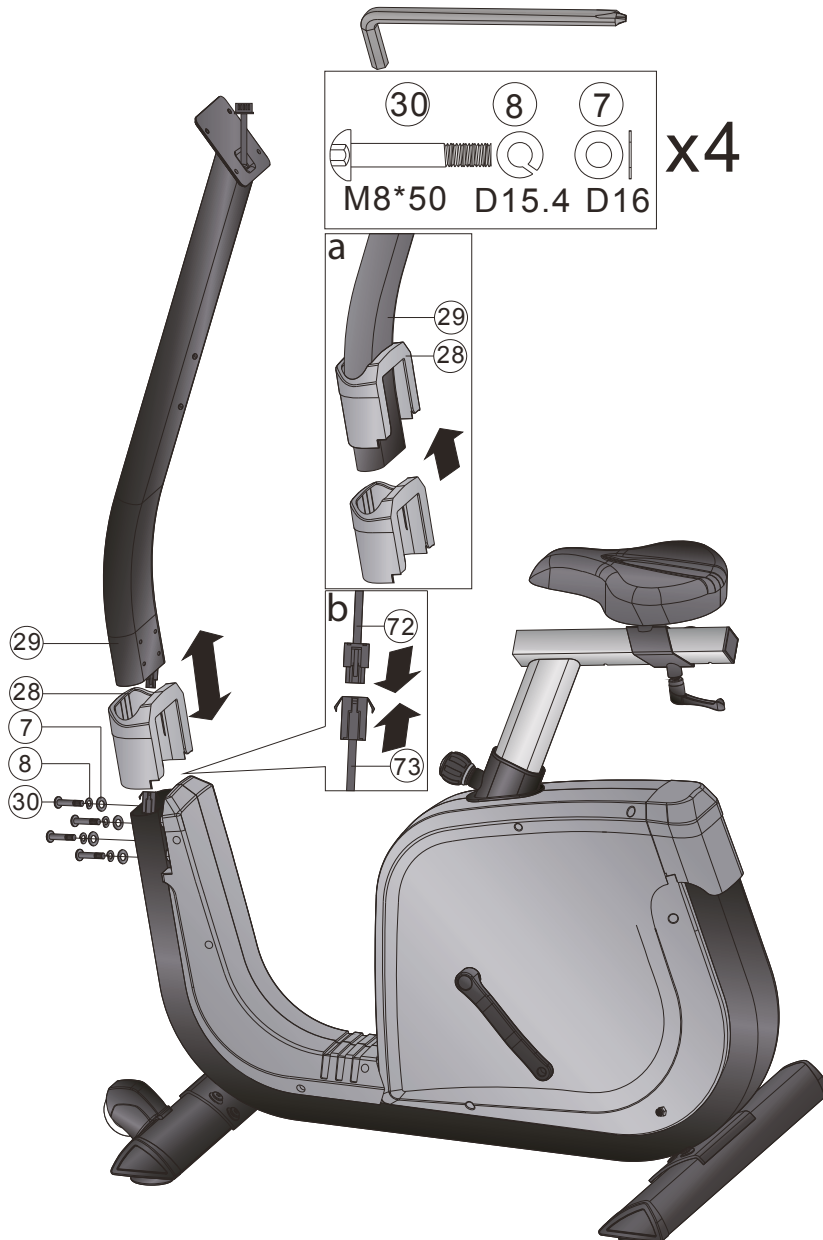

#### Step 4: Assembly of the handlebars

1. Mount the handlebars (32) on the handlebar tube (29) by means of the protective cover (65), the spacer sleeve (7), the spring washer (8), the socket screw (9) and the screw (20).
2. Make sure that all cables are correctly connected, see figure a, b, c, d.

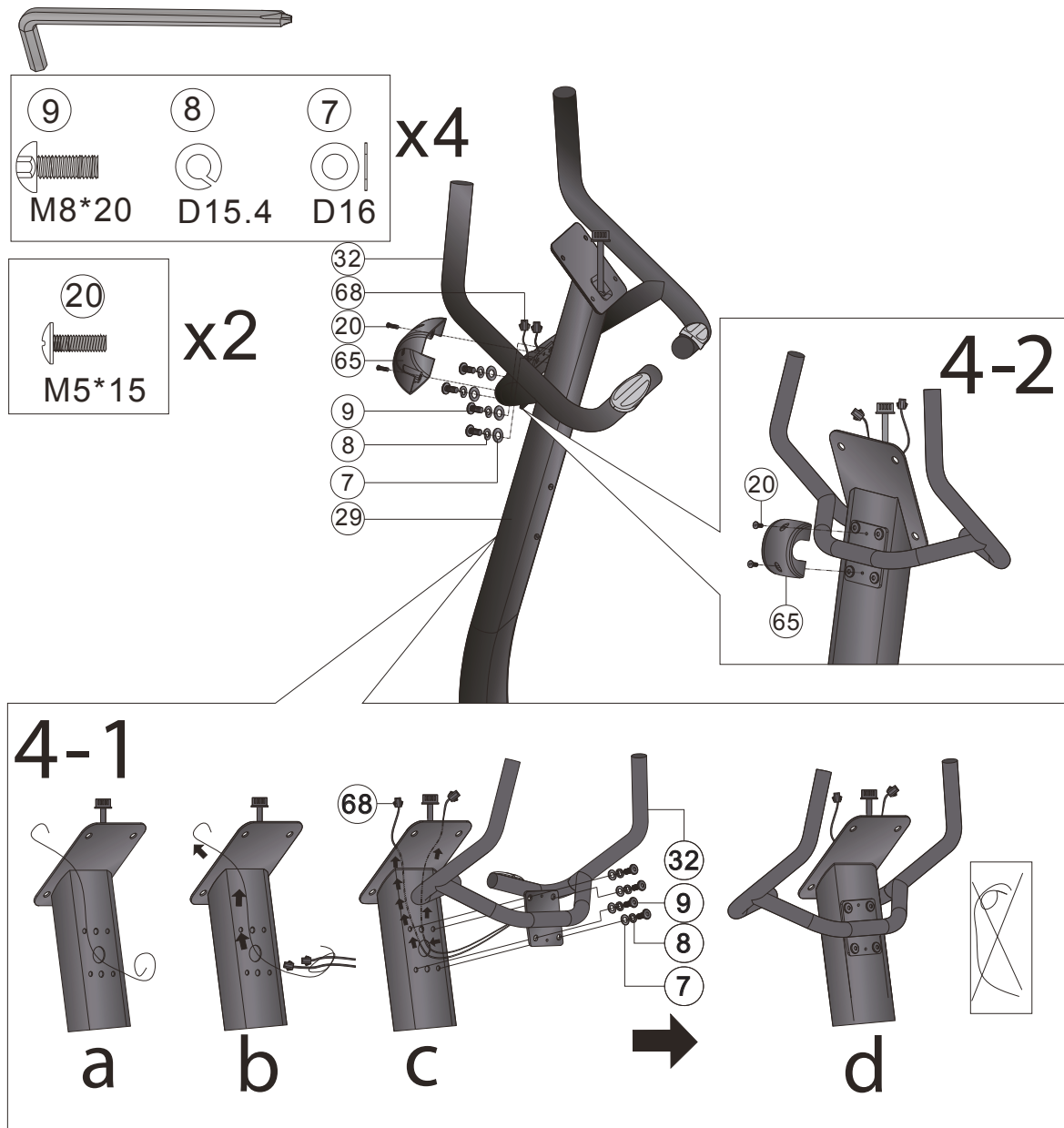

## Step 5: Assembly of the console & pedals

1. Connect the upper computer cable (72) and the hand pulse cable (68) with the computer (17) and mount the computer (17) on the handlebar tube (29) by means of the screw (64).



### CAUTION

Make sure to screw in the pedals completely.



### NOTICE:

Tighten the right pedal clockwise, and the left pedal anti-clockwise.

2. Mount the pedal (62 & 88) to the crank (35 & 89), please see figure b,c.

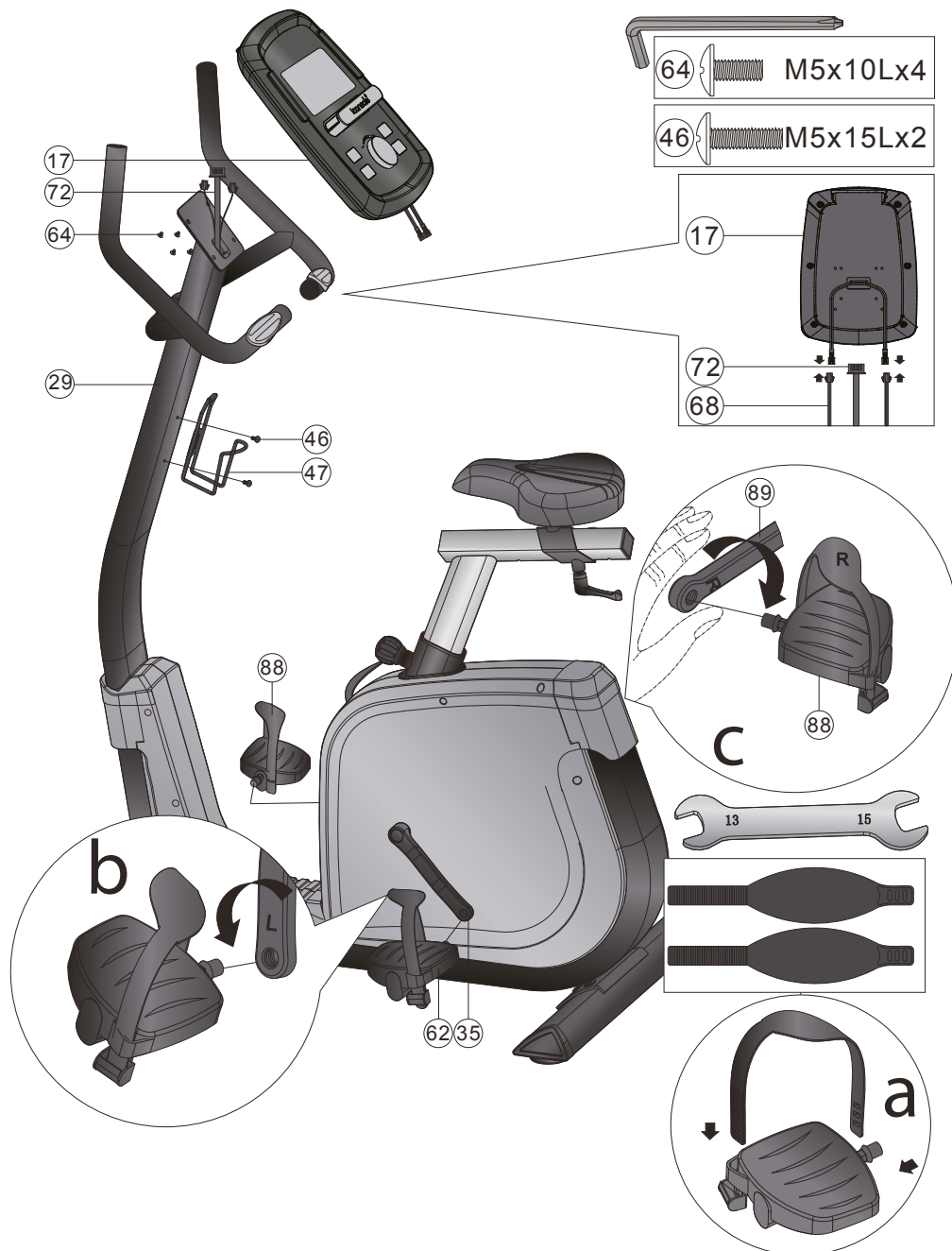

## Step 6: Alignment of the Feet

If the floor is uneven, you can stabilize the equipment by turning the two setting screws under the main frame.

1. Lift the equipment on the desired side and rotate the setting screws under the main frame.
2. Rotate the screws clockwise in order to remove them and to raise the equipment.
3. Rotate them counterclockwise in order to lower the equipment.

## Step 7: Connecting the Equipment to the Mains Supply

### ▶ ATTENTION

The equipment must not be connected to a multiple socket, otherwise it cannot be guaranteed that the equipment will be supplied with sufficient power. Technical errors can result.

Plug the power plug into a wall outlet that complies with the instructions in the chapter on electrical safety.

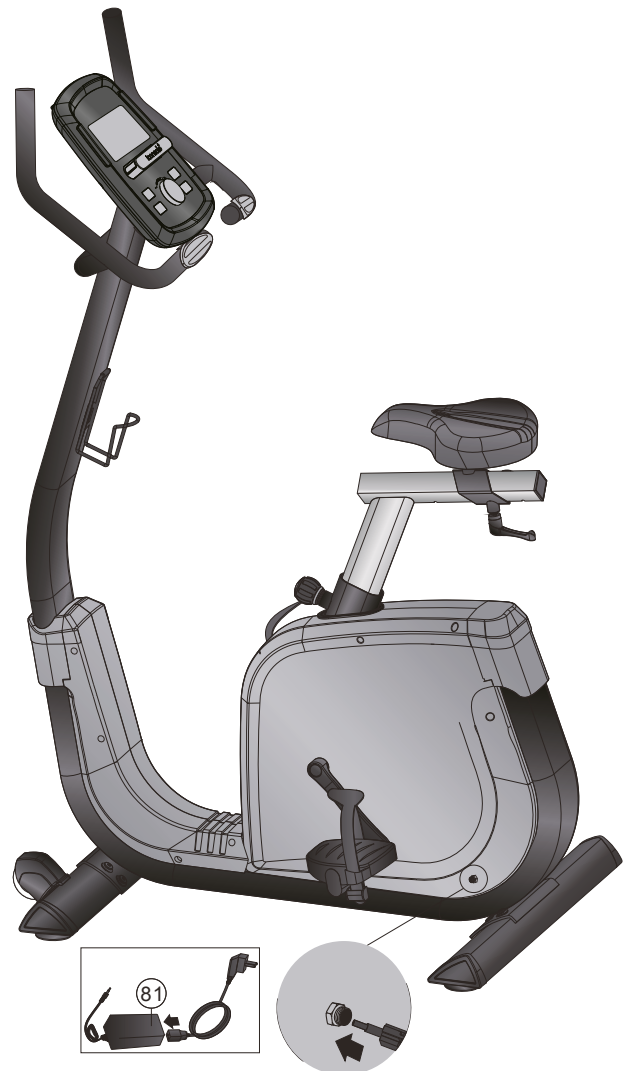

## Correctly Getting On and Off

1. To get on, grip the handles with both hands and first step onto the left pedal with your left foot or onto the right pedal with your right foot and then place your foot onto the other pedal.
2. To get off, grip the handles with both hands and place one foot next to the equipment and then the other foot.

## 3 OPERATING INSTRUCTIONS

---

### ① NOTICE

- + Familiarise yourself with all the functions and setting options of the device before starting training. Have the proper use of this product explained to you by a specialist.
- + Always start your training with low intensity and increase evenly and gently. End your training with a cool-down phase. If you are unsure, please consult your physician.

### 3.1 Console display



<b>Time</b>	<p>When no target is set, the time counts up from 00:00 to a maximum of 99:59.</p> <p>When you work out with a pre-set time, the time counts from the pre-set time down to 00:00.</p> <p>Every pre-set increment is one minute from 00:00 to 99:00.</p>
<b>Speed</b>	Displays the current training speed from 00.0 to 99.9 km/h.
<b>RPM</b>	Displays the rotations per minute. RPM range: 0 – 15 – 999.
<b>Distance</b>	<p>Counts the distance from 0.00 to 99.99 km. A target value for the distance can be set with the encoder.</p> <p>The desired distance can be set from 0.00 to 99.99 in increments of 0.1 km.</p>
<b>Calories</b>	Counts the calorie consumption during the training from 0 to a maximum of 9999 calories. (These data serve as rough guide for comparing different training sessions. However, it cannot be used for medical treatment.)
<b>Pulse</b>	A target value for pulse can be set from 30 to 230. A signal sounds on the computer, when the current heart rate exceeds the target heart rate during the training.
<b>Watts</b>	Displays the current Watt of the training. Watt range: 0 to 999. In the Watt controlled mode, the Watt value can be set from 10 to 350.
<b>Manual</b>	Manual training mode.
<b>Program</b>	Select from 12 programmes.
<b>User Program</b>	Create and save your own profile programme.
<b>H.R.C.</b>	Target heart rate training mode.
<b>Watt Program</b>	Watt programme, the resistance is adjusted according to your pedalling speed, so that you train at a constant performance (Watt). The quicker you pedal, the lower is the resistance.

## 3.2 Button Function

<b>+</b> (encoder)	Increase the resistance level. Increase values. Choose a programme.
<b>-</b> (encoder)	Reduce the resistance level. Reduce the values. Choose a programme.
<b>Mode / Enter</b>	Confirm setting of selection.
<b>Reset</b>	Hold pressed for two seconds to reboot the computer and to start with the user settings. Press shortly to return to the Stop mode or enter the training values in the main menu.
<b>Start / Stop</b>	Start or pause the training (Stop mode).
<b>Recovery</b>	Test the heart rate recovery pulse.
<b>Body fat</b>	Press the button in the stop mode to measure the body fat. During the measuring, the user holds the handles with both hands. The LCD displays "--"--"---" for eight seconds until the computer has finished the measuring. The LCD displays alternately BMI, FAT% every three seconds

## 3.3 Turning On and Setting the Equipment

Plug the adapter in the socket and the computer turns on. It displays all segments on the LCD screen for two seconds (fig. 1).

Then you start setting the user data. Select U1 to U4 with the encoder. Enter gender, age, height (fig. 2), and the weight. Confirm the settings with MODE/ENTER. When you have entered the profile of the user data, the console switches to the main menu (fig. 3).

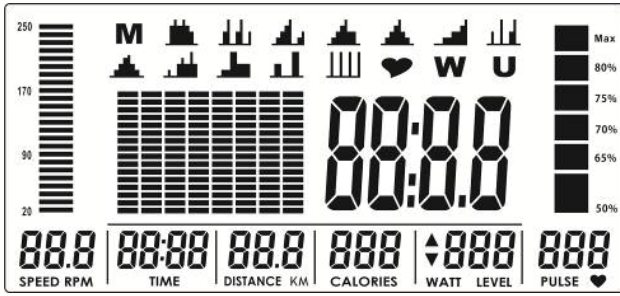

Fig. 1

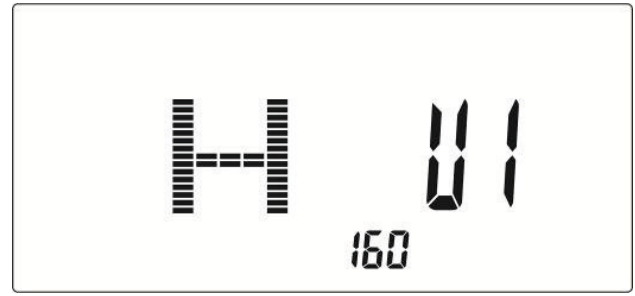

Fig. 2

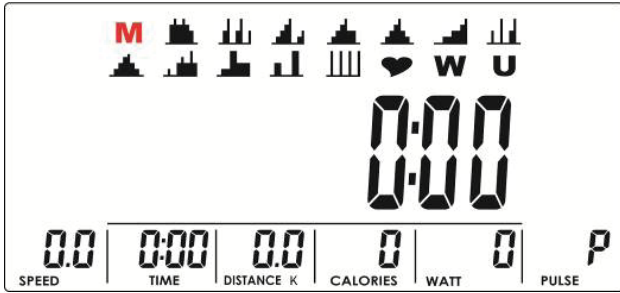

Fig. 3

### 3.4 Training programme

Select the training with the encoder: M (Manual) + P (Programme 1 to 12) + H.R.C. (heart rate controlled) + W (Watts) + U (User). Confirm the programme with MODE/ENTER.

#### 3.4.1 MANUAL MODE

Press START in the main menu to start directly the training in the manual mode.

1. Select a training programme with the encoder. Select M and confirm with MODE/ENTER.
2. Set the intensity level with the encoder (fig. 4). The default value is 1.
3. Enter the time (fig. 5), the distance (fig. 6), the calories (fig. 7), and the pulse (fig. 8) with the encoder. Confirm your settings with MODE/ENTER.
4. Press START/STOP to start the training. During the training, the intensity level can be adjusted with the encoder. When the intensity level is displayed in the WATT window, the value cannot be adjusted for three seconds. It switches to the display WATT (fig. 9).
5. Press START/STOP to pause the training. Press RESET to return to the main menu.



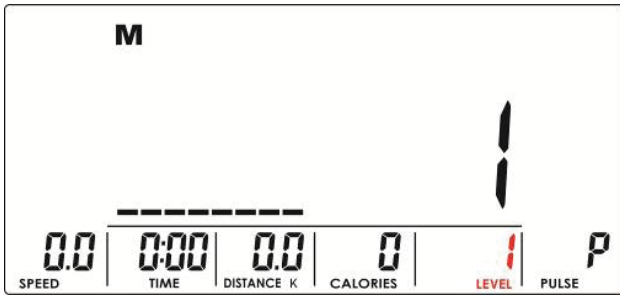

Fig. 4

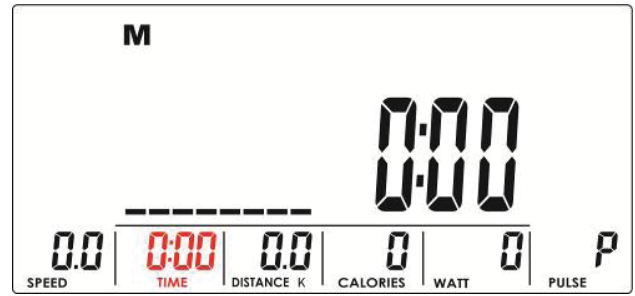

Fig. 5

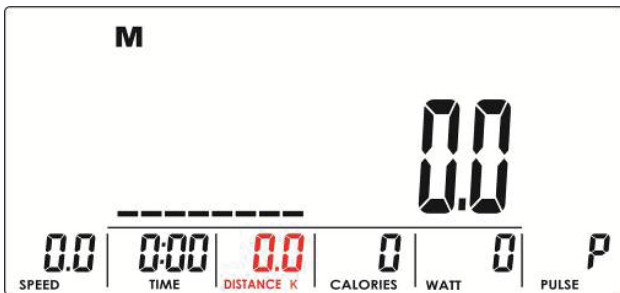

Fig. 6



Fig. 7

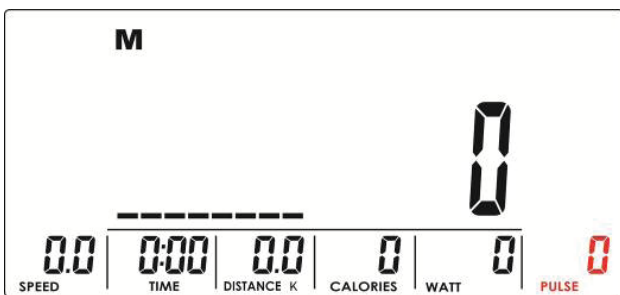

Fig. 8

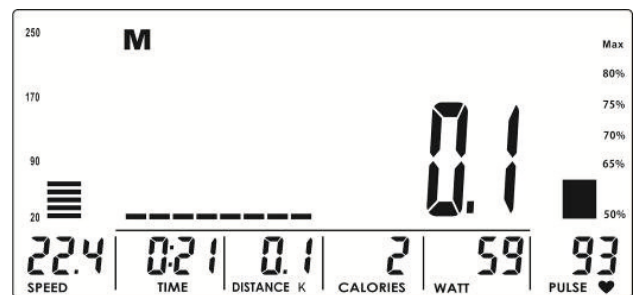

Fig. 9

### 3.4.2 PROGRAM MODE

1. Select a training programme with the encoder. Select P01, P02, P03, etc. and confirm your settings with MODE/ENTER.
2. Set the intensity level with the encoder (fig. 10). The default value is 1.
3. Enter the time with the encoder.
4. Press START/STOP to start the training. During the training, the intensity level can be adjusted with the encoder.
5. Press START/STOP to pause the training. Press RESET to return to the main menu.

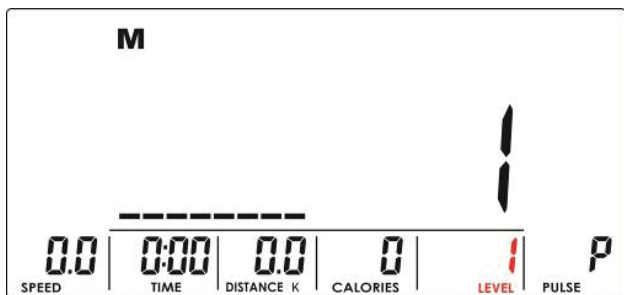

Fig. 10

### 3.4.3 H.R.C. MODE

#### ⚠ WARNING

Your training equipment is not a medical device. The heart rate measurement of this equipment may be inaccurate. Various factors can affect the accuracy of the heart rate measurement. The heart rate measurement serves only as a training aid.

1. Select a training programme with the encoder. Select H.R.C. and confirm with MODE/ENTER.
2. Select 55 % (fig. 11), 75 % (fig. 12) 90% (fig. 13) or TAG (target heart rate, default value: 100) (fig. 14) with the encoder. When you select TAG, enter a value from 30 to 230 with the encoder.
3. Enter the time with the encoder.
4. Press START/STOP to start or pause the training. Press RESET to return to the main menu.

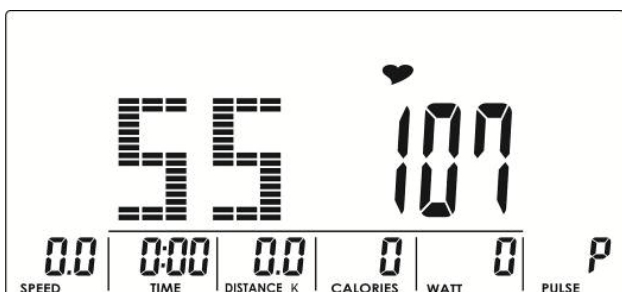

Fig. 11



Fig. 12

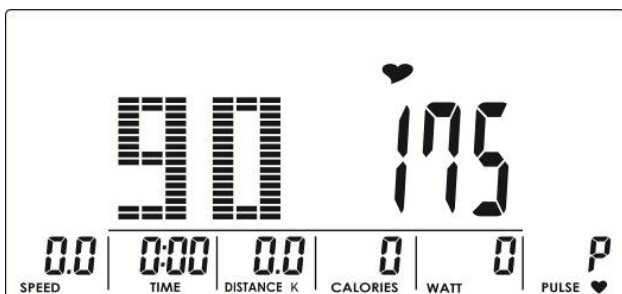

Fig. 13

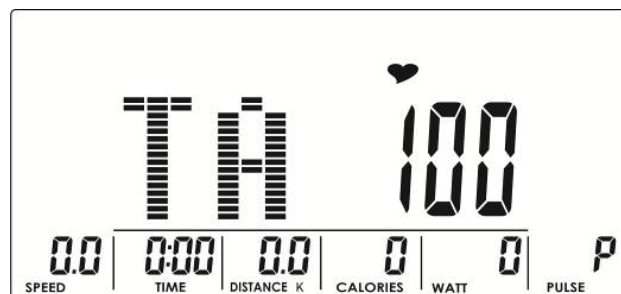

Fig. 14

### 3.4.4 WATT MODE

1. Select a training programme with the encoder. Select W and confirm with MODE/ENTER.
2. Set the WATT target (default value: 120, fig. 15) with the encoder.
3. Enter the time with the encoder.
4. Press START/STOP to start the training. During the training, the system adjusts automatically the intensity level according to the pedalling speed to keep the wattage (resistance) constant. Adjust the target WATT level with the encoder during the training.
5. Press START/STOP to pause the training. Press RESET to return to the main menu.

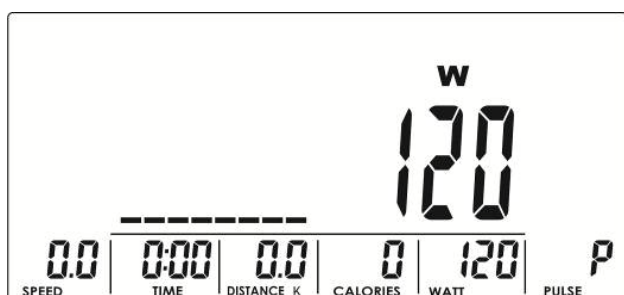

Fig. 15

### 3.4.5 USER PROGRAM MODE

1. Select a training programme with the encoder. Select U and confirm with MODE/ENTER.
2. Create a user profile (fig. 16) with the encoder. All in all, there are eight columns. The user can set the intensity level of every column. Press MODE/ENTER for two seconds to finish it during the setting.
3. Enter the time with the encoder.
4. Press START/STOP to start the training. During the training, the intensity level can be adjusted with the encoder.
5. Press START/STOP to pause the training. Press RESET to return to the main menu.

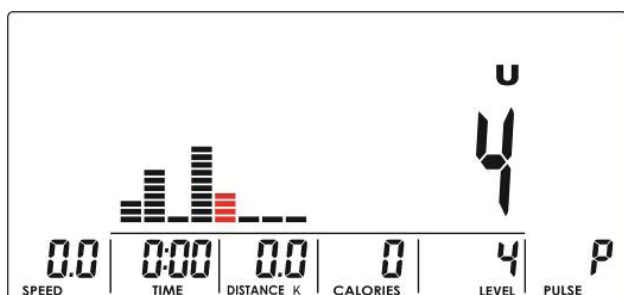

Fig. 16

### 3.4.6 RECOVERY

After the training, you hold the handles with both hands or wear a chest strap and press the RECOVERY button. The display of all functions is stopped except for TIME. The time starts to count down from 00:60 to 00:00 (fig. 17). The screen displays your heart rate recovery state with F1, F2, to F6 (fig. 18). F1 stands for the best value, F6 stands for the worst. Continue exercising to improve your heart rate recovery state. (Press RECOVERY again to return to the main display.)



Fig. 17



Fig. 18

### 3.4.7 BODY FAT

1. Press BODY FAT in the STOP mode to start the measuring of your body fat.
2. The console displays UX (fig. 19) and starts to measure (fig. 20 to 21).
3. Hold the handles with both hands during the measuring. Once the console has detected the pulse, the LCD screen displays === for eight seconds (fig. 22) until the measuring is finished.
4. The LCD screen displays the BMI (fig. 23), the fat percentage (FAT %, fig. 24), and the body fat symbol (BODY FAT, fig. 25).

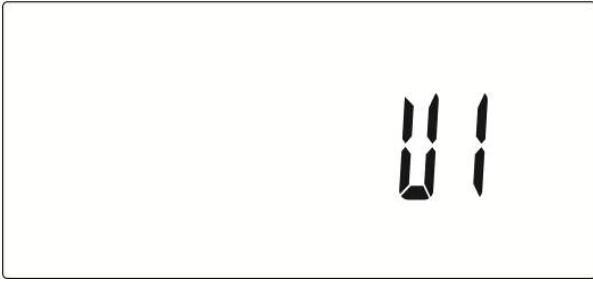

Fig. 19

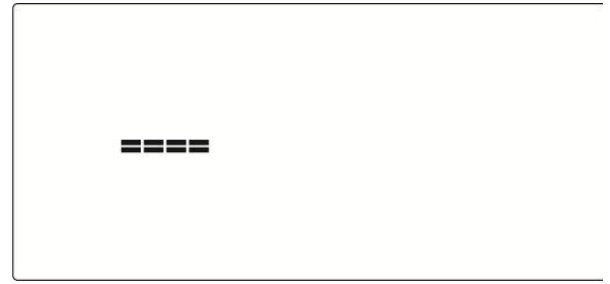

Fig. 20

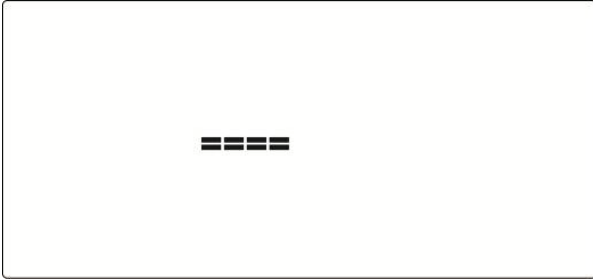

Fig. 21

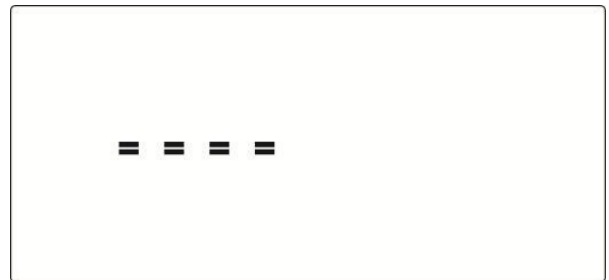

Fig. 22

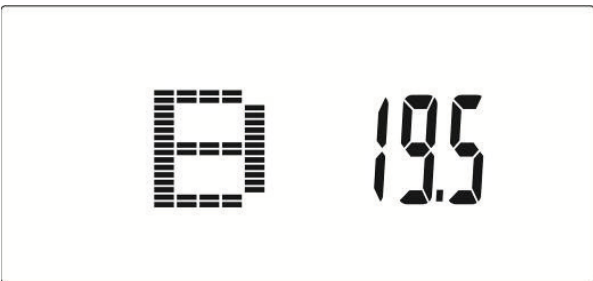

Fig. 23

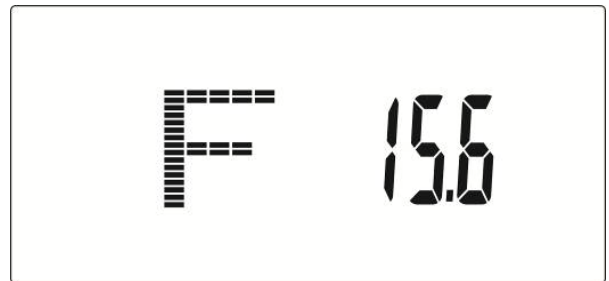

Fig. 24

SYMBOL	—	+	▲	◆
	LOW	LOW/MED	MEDIUM	MED/HIGH

Fig. 25



**NOTICE**

- + After 4 minutes without pedaling or pulse input, console will enter into power saving mode. Press any key may wake the console up.
- + When computer act abnormal, please plug out the adaptor and plug in again.

## 3.5 Connection with Kinomap

### ① NOTICE

Make sure Bluetooth is enabled on your mobile device and the console is active. Otherwise, simply tap any button except Start/Stop.

1. Open Kinomap.
2. On the main screen, select "More" in the bar at the bottom.
3. Now select "Device management" on this page. Currently connected devices are displayed here.
4. To add a new device, tap the "+" at the top right.

### ① NOTICE

There may be slight differences in menu navigation between Android and IOS.

5. Now select the type of device. You can choose from roller trainer, exercise bike, treadmill, cross trainer and rowing machine. For the BX70i, select Exercise bike/recumbent bike.
6. On the next page you will see the different brands. Select "cardiostrong" and then the BX70i.
7. Now all Bluetooth sources in the surrounding area are displayed. Select a Bluetooth source that begins with i-Console .... The number that follows is also written on a small sticker on the back of the console.

*The device is now added.*

8. Return to the main menu, select a track and enjoy a great track video.

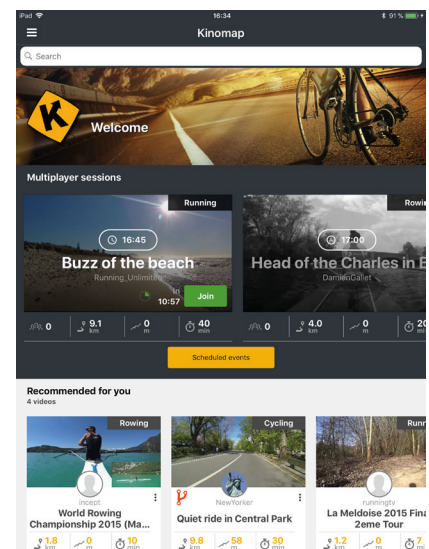
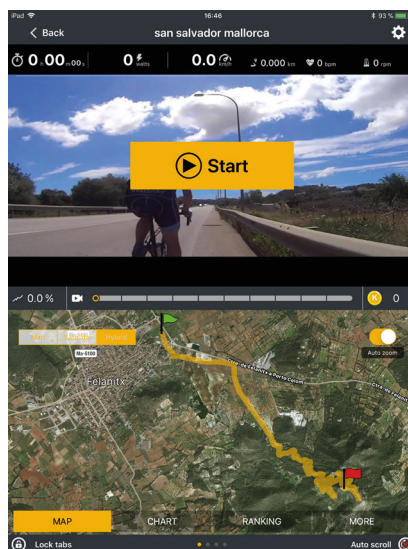
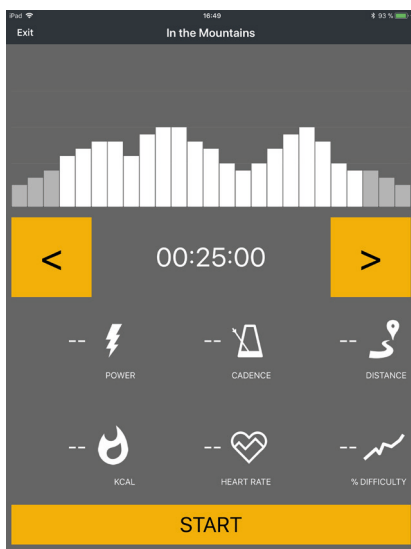

Under the QR code provided, you can watch the video of the connection with Kinomap. (<https://www.youtube.com/watch?v=KGnhAQJDIFA>)

The BX30 Plus has the same console as the BX70i, here we demonstrate the connection in a video.

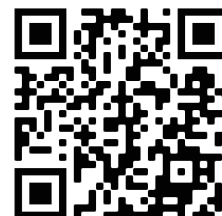

**NOTICE**

The pre-installed apps are produced and provided by external manufacturers. Changes and availability within these apps might occur. Fitshop does not take any responsibility and can not be held liable for the availability, functionality or contents of these apps.

**IMPORTANT NOTE**

To make sure the pre-installed apps are working correctly, they must be updated regularly. If needed, the respective app will notify you to do so. To update the app, you need a google account. A google email is sufficient. Just follow the instructions on the screen to perform the update. Please note: The system is set up only for the pre-installed apps. Do not install any additional apps as their proper functionality can not be guaranteed. The installation of other apps might cause technical issues.

## 4.1 General Instructions



### WARNING

- + The storage location should be chosen so that improper use by third parties or children can be prevented.
- + If your equipment does not have transportation wheels, the equipment must be disassembled before transportation.



### ATTENTION

- + Make sure that the equipment is protected from moisture, dust and dirt in the selected storage location. The storage location should be dry and well ventilated and have a constant ambient temperature between 10°C and 35°C.

## 4.2 Transportation Wheels



### ATTENTION

If you want to transport your equipment over particularly sensitive and soft floor coverings, such as parquet, planks or laminate, lay out the transport route with cardboard or similar to avoid possible floor damage.

1. Stand behind the equipment and lift it until the weight is transferred to the transportation wheels. After that, you easily can move the equipment to a new position. For long transport distances the equipment should be disassembled and safely packed.
2. Select the new location by following the instructions in the section 1.4 of this manual.



## 5.1 General Instructions



### WARNING

- + Do not make any improper changes to the equipment.



### CAUTION

- + Damaged or worn components may affect your safety and the life of the equipment. Therefore, immediately replace damaged or worn components. In such a case, contact the contract partner. The equipment must not be used until it has been repaired. If necessary, use only original spare parts.

### ATTENTION

- + In addition to the instructions and recommendations for maintenance and care given here, additional service and/or repair work may be necessary; this must only be carried out by authorised service technicians.

## 5.2 Faults and Fault Diagnosis

The equipment undergoes regular quality controls during production. Nevertheless, faults or malfunctions may occur. Frequently, individual parts are responsible for these disturbances, an exchange is usually sufficient. Please refer to the following overview for the most common errors and how to correct them. If the equipment still does not function properly, contact your contract partner.

Fault	Cause	Solution
Cracking in the pedal area	Pedals loose	Tighten the pedals
Equipment wobbles	Equipment is not level	Align the feet
Handlebar/saddle wobbles	Loose screws	Tighten screws firmly
Display is blank/is not working	Batteries empty or loose cable connection	Replace batteries or check cable connections
No pulse display	<ul style="list-style-type: none"> <li>+ Sources of interference in the room</li> <li>+ unsuitable chest strap</li> <li>+ Wrong position of chest strap</li> <li>+ Chest strap defective or battery empty</li> <li>+ Pulse display defective</li> </ul>	<ul style="list-style-type: none"> <li>+ Eliminate sources of interference (e.g. mobile phone, WLAN, lawn mower and vacuum cleaner robot, etc. ...)</li> <li>+ Use a suitable chest strap (see RECOMMENDED ACCESSORIES)</li> <li>+ Reposition chest strap and/or moisten electrodes</li> <li>+ Changing batteries</li> <li>+ Check if pulse display by hand pulse possible</li> </ul>

## 5.3 Error Codes and Troubleshooting

The electronics of the equipment continuously carries out tests. In case of deviations, an error code appears on the display and normal operation is stopped for your safety.

- + The display shows === + The handles are not correctly grasped with both hands.
- + E1 + There is no heart rate signal.
- + E4 + It is displayed, when the values of FAT % and BMI are less than 5 or higher than 50.

**Please contact the contract partner for technical support.**

## 5.4 Maintenance and Inspection Calendar

To avoid damage from body sweat, the equipment must be cleaned with a damp towel (no solvents!) after each training session.

The following routine tasks must be performed at the specified intervals:

Part	Weekly	Monthly
Display console	C	I
Plastic covers	C	I
Screws and cable connections		I
Check pedals for tightness		I
Legend: C = clean; I = inspect		

By scanning the QR-code with the camera function or QR-code scanner app of your smartphone/tablet, a video on general maintenance of an exercise bike opens on YouTube. The video serves to illustrate the maintenance points described in this manual.

Please note that the video may not be available in your language or with appropriate subtitles.

If you cannot scan QR-codes, you can access all Fitshop videos on YouTube by first opening YouTube and entering "Fitshop" in the search field.



## 6 DISPOSAL

---

At the end of its operational life, this equipment cannot be disposed of in normal household waste. Instead, it must be disposed of via an electricals recycling centre. Further information can be obtained from your local authority's recycling service.



The materials can be recycled as per their symbols. Through the reuse, recycling of materials or other forms of recovery of old equipment, you make an important contribution to the protection of the environment.

To make your training experience even more efficient and pleasant, we recommend that you add suiting accessories to your fitness equipment. For exercise bikes this could for example be a **floor mat**, which makes your fitness equipment stand more securely and also protects the floor from sweat or **silicone spray** to keep moving parts in good shape. For many exercise bikes it is possible to replace the **saddle** or **pedals**, as these are usually the same mounts used on bicycles.

If you have purchased a fitness machine with pulse training and want to train your heart rate, we strongly recommend that you use a compatible **chest strap**, as this ensures optimum transmission of the heart rate.



Our range of accessories offers the highest quality and makes training even better. If you would like to find out more about compatible accessories, please go to the detail page of the product in our webshop (the easiest way is to enter the article number in the search field above) and go to the recommended accessories on this page. Alternatively, you can use the QR-code provided. Of course, you can also contact our customer service: by telephone, e-mail, in one of our branches or via our social media channels. We will be happy to advise you!



saddle cover



chest strap



chest strap contact gel



floor mat



saddle



silicone spray

## 8.1 Serial Number and Model Name

In order to provide you with the best possible service, please have the model name, article number, serial number, exploded drawing and parts list ready. The corresponding contact options can be found in chapter 10 of this operating manual.

**NOTICE**

The serial number of your equipment is unique. It's located on a white sticker. The exact position of this sticker is shown in the following illustration.

Enter the serial number in the appropriate field.



**Serial number:**

**Brand / Category:**

**Model Name:**

**Article Number:**

## 8.2 Parts List

No.	Qty.	Name	Supplier Parts No.	Specification
1	1	Main frame	815S0-3-1000-J2	
2	1	Rear stabilizer	709S0-6-2107-J2	95.4*50.6*2.0Tx500L
3	4	Adjustable wheel	709S0-6-2174-B0	D59*M10*40L
4	1	Front stabilizer	832S0-3-2100-J0	
5	2	Tri-angle cap(left)	55357-B-5095-B8	95.7*57.2*51.3
6	2	Tri-angle cap(right)	55357-A-5095-B8	95.7*57.2*51.3
7	16	Flat washer D16*D8.5*1.2T	55108-1-1612-FA	D16*D8.5*1.2T
8	16	Spring washer D15.4 XD8.2x2T	55108-2-1520-FA	D15.4 XD8.2x2T
9	12	Allen bolt M8x1.25x20L	50308-5-0020-F0	M8x1.25x20L
10	1	Seat LS-A28	58001-6-1351-B0	LS-A28
11	1	Seat adjustment tube	84802-3-4000-J0	
14	2	Oval cap	55318-2-3838-B8	38x38x18L
15	1	quick-released knob	52712-2-0025-BA	M12*25L
16	2	round cross screw	50805-2-0010-N0	M5*0.8*10L
17	1	Computer SE-2560-31	815S1-6-2501-B1	SE-2560-31
18	2	C-clip D22.5*D18.5*1.2T	55519-1-2312-DA	D22.5*D18.5*1.2T
19	1	Rear cover	81502-6-2430-V20	137.2*61.2*158.3
20	2	Bolt M5x0.8x15L	50805-2-0015-F0	M5x0.8x15L
21	1	Belt	58004-6-1041-00	995 J6
22	1	Waved washer D27*D21*0.3T	55120-5-2703-DA	D27*D21*0.3T
23	2	Cover for wheel	832S0-6-2176-B0	93.2*64.7*62
24	1	pulley	58008-6-1017-03	D260*19
25	4	Bolt M6x1.0x15L	50106-5-0015-C0	M6x1.0x15L
26	4	Nylon nut M6x1.0x6T	55206-1-2006-CA	M6x1.0x6T
27	1	Crank axle	817S0-3-2903-00	
28	1	Upper protective cover	81800-6-4580-V20	137.1*121*73.4
29	1	Handlebar post	815S1-3-2000-J1	
30	4	Allen bolt M8*1.25*50L	50308-5-0050-UF3	M8*1.25*50L
31	1	bolt cover	18600-6-2171-B0	D29*21(M8)
32	1	Fixed handlebar	81000-3-2400-B2	
33	2	Screw cover D26*11L	81502-6-2779-B0	D26*11L
34	2	Anti-loosen nut M10*1.25*10T	70501-6-2775-N0	M10*1.25*10T

35	1	Left crank	58007-6-1082-D0	170Lx9/16"-20BC
36	1	Left chain cover	81502-6-4501-V20	534.7*502*78.1
37	1	Right chain cover	81502-6-4502-V20	534.7*502*82.7
38	2	Allen nut M6*1.0*6T	55206-2-2006-NA	M6*1*6T
39	1	Adjustable bolt	84302-6-3302-N0	M6*1.0*46
40	1	Round cycle for chain cover	81502-6-4503-B0	117*58*9.3
41	1	EMS system	801S0-3-3102-05	D265*86
42	1	Allen bolt M8x1.25x50L	50308-5-0050-C0	M8x1.25x50L
43	4	Flat washer D13*D6.5*1.0T	55106-1-1310-NA	D13*D6.5*1.0T
44	4	Spring washer D10.5*D6.1*1.3T	55106-2-1013-NA	D10.5*D6.1*1.3T
45	4	Allen screw M6*1.0*15L	54006-5-0015-D0	M6*1.0*15L
46	2	Bolt M5*0.8*15L	52605-5-0015-F0	M5*0.8*15L
47	1	Water bottle holder	186N3-6-2074-J1	
48	2	Screw ST4*25L	50904-2-0025-D0	ST4*25L
49	1	Waved washer D21xD16.2x0.3T	55116-5-2103-DA	D21xD16.2x0.3T
51	1	Plastic washer	55110-1-5010-BF	D50*D10*1.0T
52	2	Nylon nut M8*1.25*8T	55208-1-2008-NA	M8*1.25*8T
53	2	Nut M8*1.25*6T	55208-2-2006-NA	M8*1.25*6T
54	1	Fixing plate for idle wheel	742G0-3-1600-N0	
55	2	Plastic cover	803K0-6-1082-00	D3*30L
56	1	Spring D2.2*D14*65L	58003-6-1024-N0	D2.2*D14*65L
57	1	Plastic washer D10*D24*0.4T	55110-1-2404-BF	D10*D24*0.4T
58	1	Flat washer D28*D8.5*3T	55108-1-2830-NA	D28*D8.5*3T
59	2	Bearing #99502	58006-6-1016-00	#99502
60	1	C-clip S-16(1T)	55516-1-0010-00	S-16(1T)
60	1	C-clip S-16(1T)	65Mn	65Mn
62	1	Left pedal	58029-6-1105-B0	JD-36A 9/16"
63	1	Electric cable	815S0-6-2596-01	1250L
64	4	Bolt M5x10L		M5x10L
65	1	Protective cover	81000-6-2481-B0	100*81*40.8
66	1	Seat post	815S1-3-2200-C0	
67	2	Handle pulse sensor	16800-6-2478-00	PE18
68	2	Handle pulse cable	81800-6-2479-00	700L
69	1	Round magnet	174R4-6-2574-00	M02
70	2	Bearing #6004-2RS(C0)	58006-6-1040-01	#6004-2RS(C0)

71	1	Connecting cable	820S0-6-3177-00	350L
72	1	Upper computer cable	801S0-6-2572-01	1000L
73	1	Lower computer cable	815S0-6-2573-00	1800L
74	1	Sensor cable	818S0-6-2576-00	450L
75	1	Knob	52916-2-0022-G1	D50xM16x22xD8
76	1	Inner tube	195E5-6-1071-B0	40x80x129
77	1	Flat washer D24*D16*1.5T	55116-1-2415-NA	D24*D16*1.5T
78	2	Round wheel	84302-6-2175-00	D70.5*23
79	1	Bolt M5x0.8x12L	52605-2-0012-N0	M5x0.8x12L
80	2	Allen bolt M8*1.25*40L	50308-5-0040-F3	M8*1.25*40L
81	1	Adaptor	817S0-6-2584-00	OUTPUT 26V,2.3A
82	1	Controller	817S0-6-2597-00	EMS2500-A01
84	13	Screw ST4.2x1.4x20L	53342-2-0020-N0	ST4.2x1.4x20L
85	2	Nylon nut M8*1.25*8T	55208-1-2008-FA	M8*1.25*8T
86	3	pin	71600-6-4586-60	D6*26.5*7.7
87	8	screw	52804-2-0012-N0	ST4*1.41*12L
88	1	right pedal	58029-6-1105-B0	JD-36A 9/16"
89	1	right crank	58007-6-1081-D0	170Lx9/16"-20BC
90	1	front left decorative cover	81502-6-4514-V20	338.3*72.2*420.5
91	1	front right decorative cover	81502-6-4515-V20	338.3*68*420.5
92	2	screw	53342-2-0015-N0	ST4.2x1.4x15L
/	1	allen cross wrentch	58030-6-1031-N1	M6
/	1	open-end wrentch	58030-6-1035-N1	155*30*5T



## 8.3 Exploded Drawing

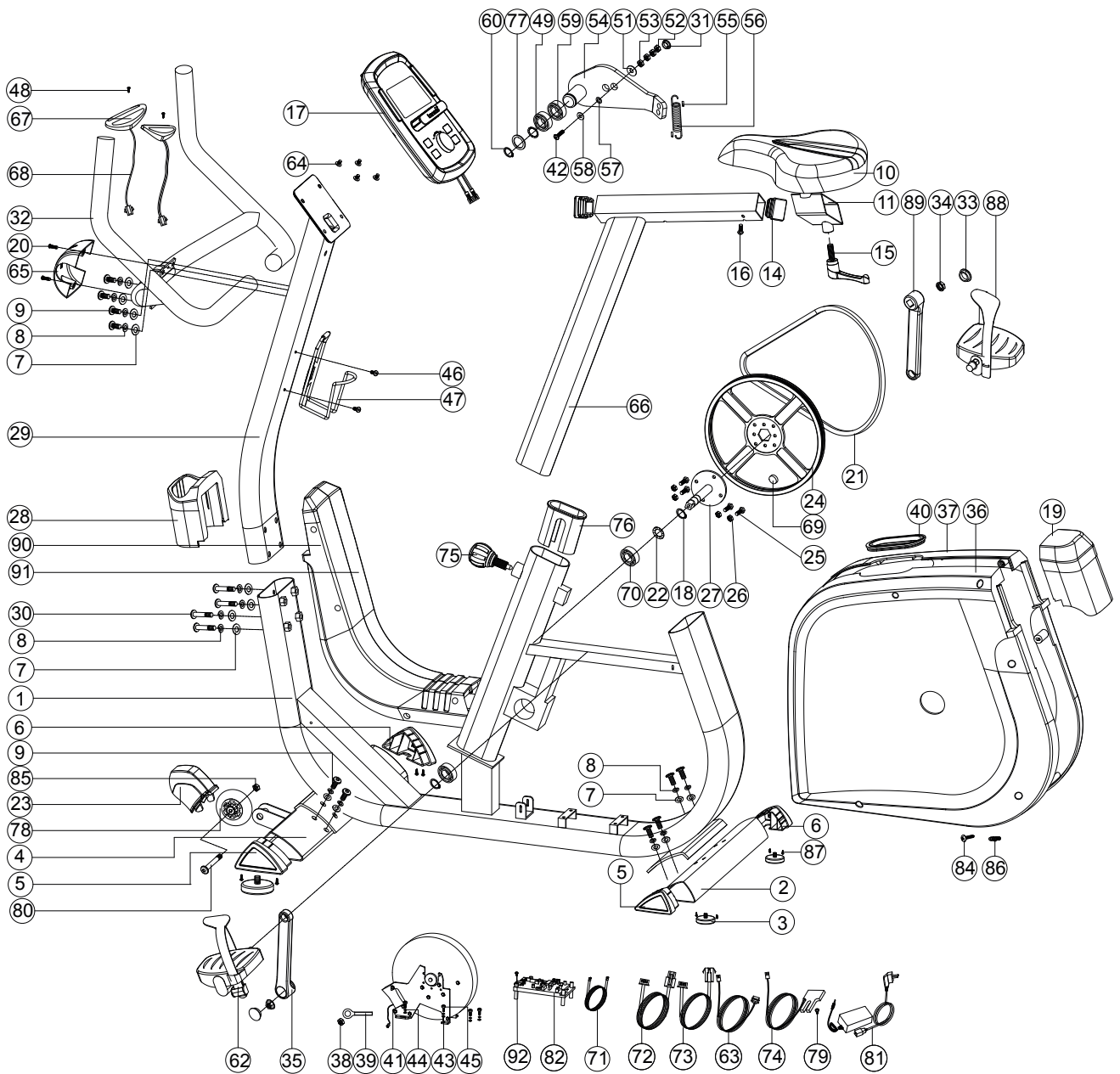

Products from cardiostrong® are subject to strict quality control. However, if a fitness equipment purchased from us does not work perfectly, we take it very seriously and ask you to contact our customer service as indicated. We are happy to help you by phone via our service hotline.

### **Error Descriptions**

Your fitness equipment is developed for long-term, high-quality training. However, should a problem arise, please first read the operating instructions. For further assistance, please contact your contract partner or call our service hotline. To ensure your problem is solved as quickly as possible, please describe the defect as exactly as possible.

In addition to the statutory warranty, we provide a warranty for every fitness equipment purchased from us according to the following provisions.

**Your statutory rights are not affected.**

### **Warrantee**

The warrantee is the first/original buyer and/or any person who received a newly purchased product as a gift from the original buyer.

### **Warranty period**

The warranty periods, shown on our web shop, begin on delivery of the fitness equipment. The respective warranty periods for your equipment can be found on its product website.

### **Repair Costs**

According to our choice, there will either be a repair, a replacement of individual damaged parts or a complete replacement. Spare parts, that have to be mounted while assembling the equipment, have to be replaced by the warrantee personally and are not a part of repair. After the expiration of the warranty period, the responsibility for parts costs, repair costs, installation costs and delivery costs lies with the warranty holder.

### **The terms of use are defined as follows:**

- + Home use: solely for private use in private households up to 3 hours per day
- + Semi-professional use: up to 6 hours per day (e. g. rehabilitation centres, hotels, clubs, company gyms)
- + Professional use: more than 6 hours per day (e. g. commercial gyms)

### **Warranty Service**

Within the warranty period, equipment which develops faults as a result of material or manufacturing defects, will be repaired or replaced at our discretion. Ownership of equipment or parts of equipment which have been replaced is transferred to us. The warranty period is not extended nor does a new warranty period begin following repair or replacement under the warranty.

## Warranty Conditions

For the warranty to be valid, the following steps must be taken:

Please contact our customer service by email or phone. If the product under warranty has to be sent in for repair, the seller bears costs. After expiry of the warranty, the buyer bears the costs of transport and insurance. If the fault is covered by our warranty, you will receive a new or repaired equipment in return.

### Warranty claims are invalid in case of damage resulting from:

- + misuse or improper handling
- + environmental influences (moisture, heat, electrical surge, dust, etc.)
- + failure to follow the current safety measures for the equipment
- + failure to follow the operating instructions
- + use of force (e. g. hitting, kicking, falling)
- + interventions which were not carried out by one of our authorized service centres
- + unauthorised repair attempts

### Proof of Purchase and Serial Number

Please make sure that you are able to provide the appropriate receipt when claiming on your warranty. So that we can clearly identify the model of your equipment, and for the purposes of our quality control, you will need to give the serial number of your equipment, when contacting the service team. Where possible please have your serial number and your customer number ready when you call our service hotline. It will help us to deal with your request swiftly.







































If you cannot find the serial number on your fitness equipment, our service team is at your disposal to offer further information.

### Service outside of the Warranty Period

We are also happy to issue an individual cost estimate if there is a problem with your fitness equipment after the warranty has expired, or in cases which do not fall under the terms of the warranty, e. g. normal wear and tear. Please contact our customer service team to find a quick and cost-effective solution to your problem. In such a case you will be responsible for the delivery costs.

### Communication

Many problems can be solved just by speaking to us as your specialist supplier. We know how important it is to you as a user of the fitness equipment to have problems solved quickly and simply, so you can enjoy working out with minimal interruption. For that reason, we also want to resolve your queries quickly and in a straightforward manner. Thus, please always keep your customer number and the serial number of the faulty equipment handy.

DE	DK	UK
<p><b>TECHNIK</b></p> <p> +49 4621 4210-900</p> <p> +49 4621 4210-698</p> <p> <a href="mailto:technik@fitshop.de">technik@fitshop.de</a></p> <p> Öffnungszeiten entnehmen Sie unserer Homepage.</p> <p><b>SERVICE</b></p> <p> 0800 20 20277 (kostenlos)</p> <p> 04621 4210 - 0</p> <p> <a href="mailto:info@fitshop.de">info@fitshop.de</a></p> <p> Öffnungszeiten entnehmen Sie unserer Homepage: <a href="https://stg.fit/statita">https://stg.fit/statita</a></p>	<p><b>TEKNIK OG SERVICE</b></p> <p> 80 90 16 50</p> <p>+49 4621 4210-945</p> <p> <a href="mailto:info@fitshop.dk">info@fitshop.dk</a></p> <p> Åbningstider kan findes på hjemmesiden: <a href="https://stg.fit/statit7">https://stg.fit/statit7</a></p> <p><b>FR</b></p> <p><b>TECHNIQUE &amp; SERVICE</b></p> <p> +33 (0) 189 530984</p> <p>+49 4621 42 10 933</p> <p> <a href="mailto:info@fitshop.fr">info@fitshop.fr</a></p> <p> Vous trouverez les heures d'ouverture sur notre site Internet: <a href="https://stg.fit/statit4">https://stg.fit/statit4</a></p>	<p><b>CUSTOMER SUPPORT</b></p> <p> 00800 2020 2772</p> <p>+494621 4210 944</p> <p> <a href="mailto:info@fitshop.co.uk">info@fitshop.co.uk</a></p> <p> You can find the opening hours on our homepage: <a href="https://stg.fit/statitc">https://stg.fit/statitc</a></p> <p><b>BE</b></p> <p><b>TECHNIQUE &amp; SERVICE</b></p> <p> 02 732 46 77</p> <p>+49 4621 4210 933</p> <p> <a href="mailto:info@fitshop.be">info@fitshop.be</a></p> <p> Vous trouverez les heures d'ouverture sur notre site Internet: <a href="https://stg.fit/statit8">https://stg.fit/statit8</a></p>
ES	NL	INT
<p><b>TECNOLOGÍA Y SERVICIOS</b></p> <p> 911 238 029</p> <p> <a href="mailto:info@fitshop.es">info@fitshop.es</a></p> <p> Consulta nuestro horario de apertura en la página web: <a href="https://stg.fit/statit5">https://stg.fit/statit5</a></p>	<p><b>TECHNISCHE DIENST &amp; SERVICE</b></p> <p> +31 172 619961</p> <p> <a href="mailto:service@fitshop.nl">service@fitshop.nl</a></p> <p> De openingstijden vindt u op onze homepage: <a href="https://stg.fit/statit3">https://stg.fit/statit3</a></p>	<p><b>TECHNICAL SUPPORT &amp; SERVICE</b></p> <p> +49 4621 4210-944</p> <p> <a href="mailto:service-int@fitshop.de">service-int@fitshop.de</a></p> <p> You can find the opening hours on our homepage: <a href="https://stg.fit/statita">https://stg.fit/statita</a></p>
PL	AT	CH
<p><b>DZIAŁ TECHNICZNY I SERWIS</b></p> <p> 22 307 43 21</p> <p>+49 4621 42 10-948</p> <p> <a href="mailto:info@fitshop.pl">info@fitshop.pl</a></p> <p> Godziny otwarcia można znaleźć na stronie głównej: <a href="https://stg.fit/statit6">https://stg.fit/statit6</a></p>	<p><b>TECHNIK &amp; SERVICE</b></p> <p> 0800 20 20277 (Freecall)</p> <p>+49 4621 42 10-0</p> <p> <a href="mailto:info@fitshop.at">info@fitshop.at</a></p> <p> Öffnungszeiten entnehmen Sie unserer Homepage: <a href="https://stg.fit/statitb">https://stg.fit/statitb</a></p>	<p><b>TECHNIK &amp; SERVICE</b></p> <p> 0800 202 027</p> <p>+49 4621 42 10-0</p> <p> <a href="mailto:info@fitshop.ch">info@fitshop.ch</a></p> <p> Öffnungszeiten entnehmen Sie unserer Homepage: <a href="https://stg.fit/statit9">https://stg.fit/statit9</a></p>

Please find a detailed overview including address and opening hours for all stores of the Fitshop Group in Germany and abroad on the following website:

[www.fitshop.com/en/stores](http://www.fitshop.com/en/stores)

# WE LIVE FITNESS

## WEBSHOP AND SOCIAL MEDIA

Fitshop is Europe's largest specialist store for home fitness equipment with currently over 70 stores and one of the world's most renowned online mail order companies for fitness equipment. Private customers order via the 25 web shops in the respective national language or have their desired equipment assembled on site. In addition, the company supplies fitness studios, hotels, sports clubs, companies and physio practices with professional equipment for endurance and strength training.

Fitshop offers a wide range of fitness equipment from renowned manufacturers, high-quality in-house developments and comprehensive services, such as a build-up service and sports scientific advice before and after the purchase. The company employs numerous sports scientists, fitness trainers and competitive athletes.

Visit us also on our social media platforms or our blog!

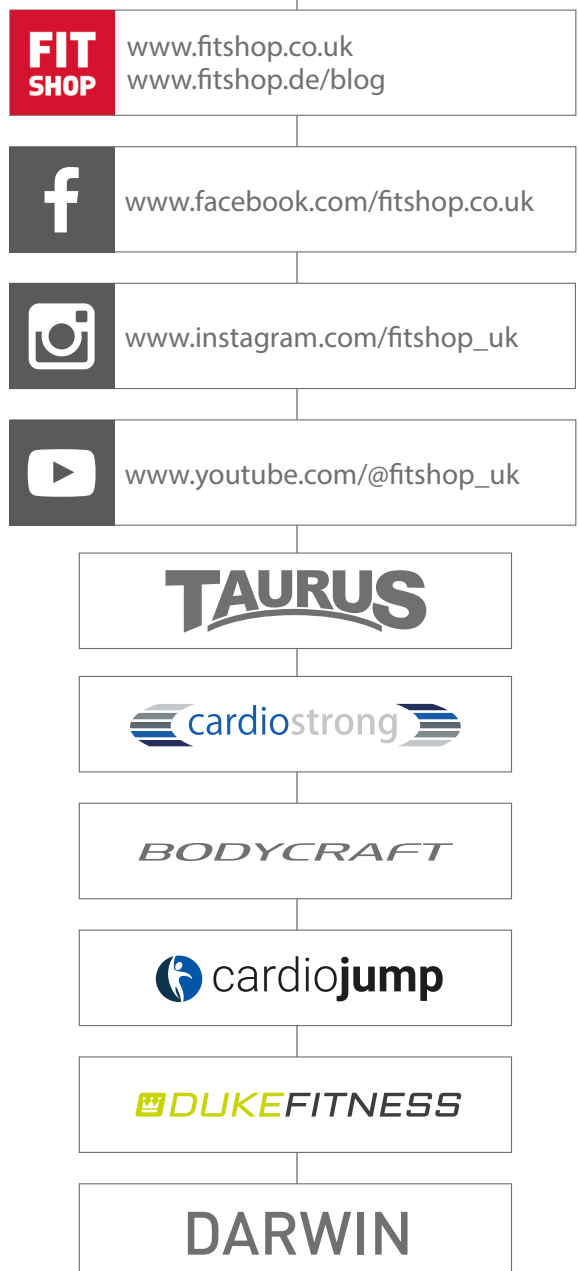

Notes

