



Assembly and Operating Instructions



max. 150 kg



~ 90 Min.



131 kg

L 145 | W 88 | H 165

FSCSTEX90PLUST.01.01

Art. No. CST-EX90-PLUS-T

Crosstrainer **EX90 Touch**

Content

1	GENERAL INFORMATION	8
1.1	Technical Data	8
1.2	Personal Safety	9
1.3	Electrical Safety	10
1.4	Set-Up Place	11
2	ASSEMBLY	12
2.1	General Instructions	12
2.2	Scope of Delivery	13
2.3	Assembly	15
3	OPERATING INSTRUCTIONS	24
3.1	Console Display	24
3.2	Button Functions	25
3.3	Switching On and Initial Settings	26
3.4	Programmes	28
3.4.1	Quick-Start Programme	28
3.4.2	Manual Programme	29
3.4.3	Pre-Set Programmes	29
3.4.4	Watt Programme	30
3.4.5	Heart Rate Controlled Programmes	30
3.5	Recovery Function	31
3.6	Training Record	32
3.7	Multimedia and Software Updates	33
3.7.1	Retrieving Apps from the Main Menu	34
3.7.2	Access to Apps During Your Workout	34
4	STORAGE AND TRANSPORT	35
4.1	General Instructions	35
4.2	Transportation Wheels	35
5	TROUBLESHOOTING, CARE AND MAINTENANCE	36
5.1	General Instructions	36
5.2	Faults and Fault Diagnosis	36
5.3	Error Codes and Troubleshooting	37
5.4	Maintenance and Inspection Calendar	38
6	DISPOSAL	38

7	RECOMMENDED ACCESSORIES	39
8	ORDERING SPARE PARTS	40
8.1	Serial Number and Model Name	40
8.2	Parts List	41
8.3	Exploded Drawing	45
9	WARRANTY	47
10	CONTACT	49

Dear customer,

thank you for choosing fitness equipment from cardiostrong®. cardiostrong offers high-quality home fitness equipment that is optimally adapted to the conditions at home. Train at home no matter what the weather or time of the day. cardiostrong fitness equipment offers training programmes and a variety of equipment for all training levels and all training goals.

Further information can be found at www.fitshop.com or www.cardiostrong.de.

We hope you enjoy your training!

Intended Use

The equipment may only be used for its intended purpose.

The equipment is suitable for home use and semi-professional use (e.g. hospitals, clubs, hotels, schools, etc.). The equipment is not suitable for commercial or professional use (e.g. fitness studio).

► **ATTENTION**

The console of this fitness device uses software that is perfectly adapted to the equipment. Please do not make any unauthorised modifications, such as the installation of external apps. This can affect the functionality of the console or even make it unusable. Only install the necessary updates in the Software Updater.

Legal Notice

Fitshop GmbH
Europe's No. 1 for home fitness

International Headquarters
Flensburger Straße 55
24837 Schleswig
Germany

Management:
Christian Grau
Sebastian Campmann
Dr. Bernhard Schenkel
No. HRB 1000 SL
Local Court Flensburg
European VAT Number: DE813211547

Disclaimer

© cardiostrong is a registered brand of the company Fitshop GmbH. All rights reserved. Any use of this trademark without the explicit written permission of Fitshop is prohibited.

Product and manual are subject to change. Technical data can be changed without advance notice.

FITSHOP

Europe's No.1 for Home Fitness

ABOUT THIS MANUAL

Please carefully read the entire manual before installation and first use. The manual will help you to quickly set up the system and explains how to safely use it. Make sure that all persons exercising with the equipment (especially children and persons with physical, sensory, mental or motor disabilities) are informed about this manual and its contents in advance. In case of doubt, responsible persons must supervise the use of the equipment.

Due to ongoing changes and software optimisations, the manual may have to be updated. If you notice any discrepancies during assembly or use, please refer to the manual uploaded to the webshop. The latest manual is always available there.

This equipment has been manufactured according to the latest safety knowledge. As far as possible, potential safety hazards which could cause injury have been eliminated. Make sure to carefully follow the instructions and that all parts are securely in place. If required, read through the instructions again to correct any mistakes.



Training devices must be classified according to accuracy and use. Accuracy classes are only applicable to devices that display training data.

Accuracy classes

Class A: high accuracy.

Class B: medium accuracy.

Class C: low accuracy.

The use classes explain the intended use of the training device.

Use classes

Class S (studio): professional and/or commercial use.

These training devices are intended for the use in training rooms of facilities such as sports clubs, school facilities, hotels, clubs and studios whose access and supervision is specifically regulated by the owner (person with legal responsibility).

Class H (home use): use at home.

These stationary training devices are intended for the use in private homes where access to the training device is regulated by the owner (person with legal responsibility).

Please pay close attention to the safety and maintenance instructions given here. The contract partner cannot be held liable for damage to health, accidents or damage to the equipment when it is not used in accordance with these instructions.

The following safety instructions may appear in this manual:

► **ATTENTION**

This notice indicates potentially hazardous situations which, if not avoided, may result in property damage.

⚠ **CAUTION**

This notice indicates potentially hazardous situations which, if not avoided, may result in slight or minor injuries!

⚠ **WARNING**

This notice indicates potentially hazardous situations which, if not avoided, may result in death or serious injuries!

⚠ **DANGER**

This notice indicates potentially hazardous situations which, if not avoided, will result in death or serious injuries!

ⓘ **NOTICE**

This notice indicates further useful information.

Retain these instructions in a safe place for future reference, maintenance or when ordering replacement parts.

1.1 Technical Data

**Check your TFT console regularly for possible software updates.
If available, make sure to carry out the updates.**

TFT display of

- + speed in km/h
- + training time in min
- + training distance in km
- + cadence (rotations per minute)
- + calories burnt in kcal
- + heart rate (when using the hand sensors or a chest strap)
- + Watt
- + resistance level

Resistance system:	electronic magnetic brake system
Resistance level:	16
Min. and max. wattage at 60 RPM:	59-258 Watt
Min. and max. wattage at 100 RPM:	135 - 562 Watt
Adjustable range in the Watt programme:	30-400 Watt (adjustable in 5-Watt increments)
User memory:	4
Quick Start programmes:	1
Manual programmes:	3
Pre-set programmes:	60
Watt-controlled programmes:	1
Heart rate controlled programmes:	4
Balance mass:	12 kg
Step width:	11 cm
Electronic step length adjustment:	45 cm (18"), 50 cm (20"), 55 cm (22"), 60 cm (24"), 65 cm (26")
Weight and dimensions:	
Article weight (gross, including packaging):	144 kg
Article weight (net, without packaging):	131 kg
Packaging dimensions (L x W x H) approx.:	140 cm x 115 cm x 49 cm
Set-up dimensions (L x W x H) approx.:	145 cm x 88 cm x 165 cm
Maximum user weight:	150 kg/330 lbs
Use class:	S

1.2 Personal Safety

DANGER

- + Before you start using the equipment, you should consult your physician that this type of exercise is suitable for you from a health perspective. Particularly affected are persons who: have a hereditary disposition to high blood pressure or heart disease, are over the age of 45, smoke, have high cholesterol values, are overweight and/or have not exercised regularly in the past year. If you are under medical treatment that affects your heart rate, medical advice is absolutely essential.
- + Note that excessive training can seriously endanger your health. Please also note that heart rate monitoring systems can be inaccurate. If you notice any signs of weakness, nausea, dizziness, pain, shortness of breath, or other abnormal symptoms, stop exercising immediately and seek advice from your doctor if necessary.
- + The owner must communicate all warnings and instructions to the user.

WARNING

- + This equipment may not be used by children under the age of 14.
- + Children should not be allowed unsupervised access to the equipment.
- + Persons with disabilities must have a medical license and must be under strict observation when using the equipment.
- + Remember that your device does not have a freewheel function. Therefore moving parts cannot be stopped immediately.
- + Note that the individual physical power required to perform an exercise may differ from the displayed mechanical power.
- + When ascending and descending, make sure that one of the treads is in the lowest position.
- + The equipment is strictly for use by one person at a time.
- + Keep your hands, feet and other body parts, hair, clothing, jewellery and other objects well clear of moving parts.
- + During use, wear suitable sports clothing rather than loose or baggy clothing. When wearing sports shoes, make sure they have suitable soles, preferably made of rubber or other non-slip materials. Shoes with heels, leather soles, studs or spikes are unsuitable. Never exercise barefoot.

CAUTION

- + If your equipment needs to be connected to the power supply with a mains cable, make sure that the cable is not a potential tripping hazard.
- + Make sure that nobody is within the range of motion of the equipment during training so as not to endanger you or other persons.
- + Do not insert any objects of any kind into the openings of the device.
- + Be aware that if adjustment devices are left protruding, they may impede the user's movement.

1.3 Electrical Safety

DANGER

- + In order to reduce the risk of an electric shock, always unplug the equipment from the mains socket immediately after your workout, before assembly or dismantling, and before maintenance or cleaning. Do not pull on the cable.

WARNING

- + Do not leave the equipment unattended while the mains cable is plugged into the mains socket. During your absence, the mains cable must be removed from the mains socket to prevent improper use by third parties or children.
- + If the mains cable or plug is damaged or defective, contact your contract partner. Until repair, the equipment must not be used.

ATTENTION

- + The equipment requires a mains connection of 220-230 V with 50 Hz mains voltage.
- + The equipment may only be connected directly to an earthed socket using the supplied mains cable. Extension cables must conform to VDE guidelines. Always completely unwind the mains cable.
- + The socket must be protected by a fuse with a minimum fuse rating of "16 A, slow blow".
- + Do not make any changes to the mains cable or the mains plug.
- + Keep the mains cable away from water, heat, oil and sharp edges. Do not route the mains cable underneath the equipment or under a carpet or rug, and do not place any objects on top of it.
- + If your purchased item is equipped with a TFT console, software updates must be carried out regularly. Follow the instructions on the console to perform the update(s).
- + The software systems on gym equipment with TFT consoles are set up only for the pre-installed apps. Do not install any additional apps.

NOTICE

- + The pre-installed apps on TFT consoles are produced and provided by external manufacturers. Fitshop does not take any responsibility for the availability, functionality or contents of these apps.

1.4 Set-Up Place

WARNING

- + Do not place the equipment in main corridors or escape routes.

CAUTION

- + Choose a location in which to place the equipment such that there is enough free space/clearance to the front, the rear and to the sides of the equipment.
- + The training room should be well ventilated during training and not be exposed to any draughts.
- + Choose the place in which to set up the equipment such that there is enough free space/clearance to the front, the rear and to the sides of the equipment.
- + The free area in the direction from which the exercise equipment is accessed must be at least 0.6 m larger than the exercise area.
- + The set-up and mounting surface of the equipment should be flat, loadable and solid.

ATTENTION

- + The device may only be used in one building, in sufficiently tempered and dry rooms (ambient temperatures between 10°C and 35°C). The equipment should not be used outdoors or in rooms with high humidity (over 70%) like swimming pools.
- + A floor protective mat/equipment underlay can help to protect high-quality floor coverings (parquet, laminate, cork, carpets) from dents and sweat and can help to level out slight unevenness.
- + For Class S equipment, the exercise equipment may only be used in areas where access, supervision and control are specifically regulated by the owner.

2.1 General Instructions



DANGER

- + Do not leave any tools, packaging materials such as foils or small parts lying around, as otherwise there is a danger of suffocation for children. Keep children away from the equipment during assembly.



WARNING

- + Pay attention to the instructions attached to the equipment in order to reduce the risk of injuries.



CAUTION

- + Ensure to have sufficient room for movement in each direction during assembly.
- + The assembly of the equipment must be carried out by at least two adults. If in doubt, seek the help of a third technically skilled person.



ATTENTION

- + To prevent damage to the equipment and the floor, assemble the equipment on a mat or packaging board.



NOTICE

- + In order to make the assembly as simple as possible, some screws and nuts to be used can already be pre-assembled.
- + Ideally, assemble the equipment at its later set-up place.

2.2 Scope of Delivery

The scope of delivery consist of the following parts. At the beginning, check whether all parts and tools belonging to the device are included in the scope of delivery and whether damage has occurred. In the event of complaints, the contractual partner must be contacted directly.

⚠ CAUTION

If parts of the scope of delivery are missing or damaged, the assembly must not be carried out.

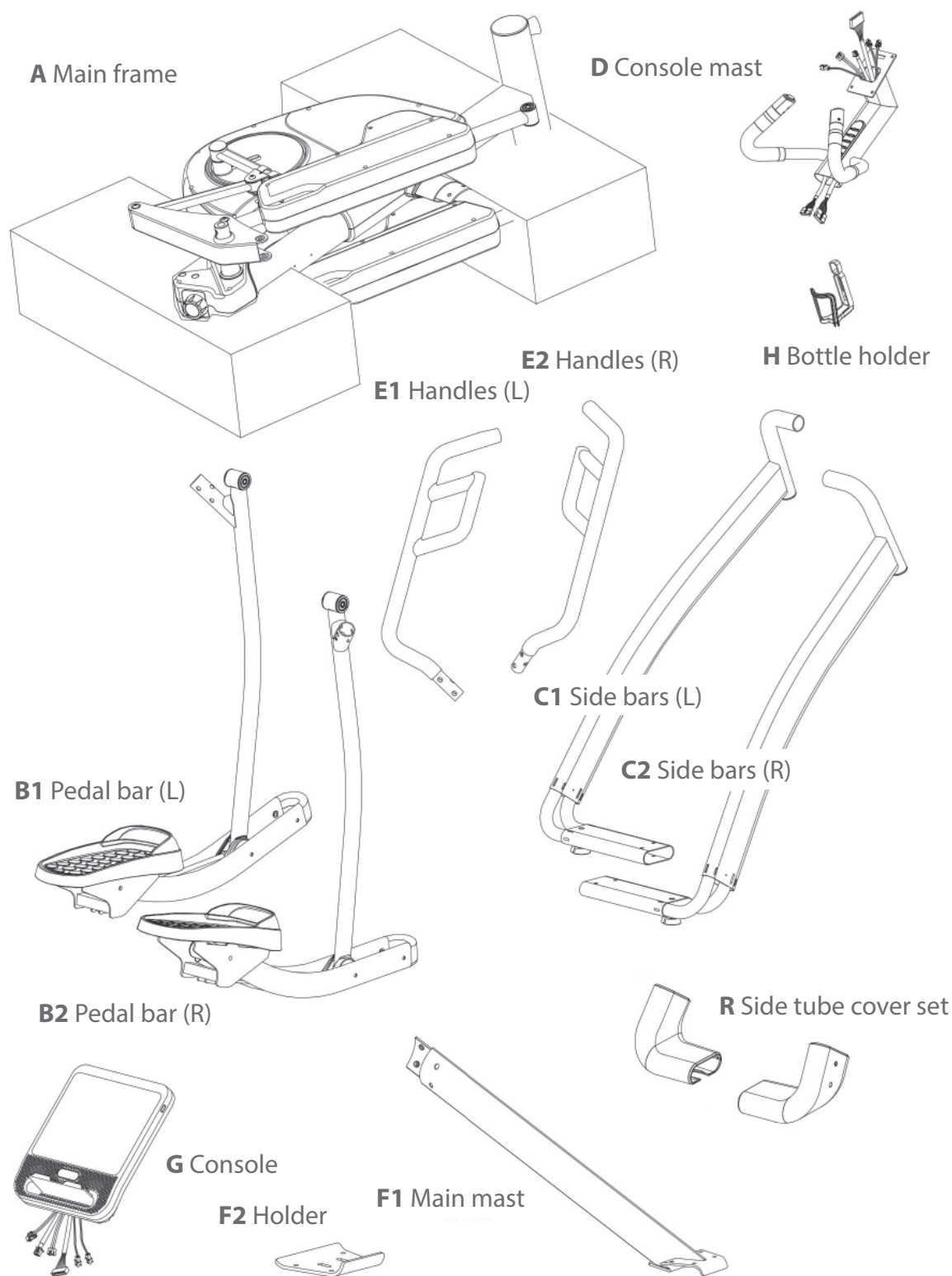

(J2) Screws M4x16

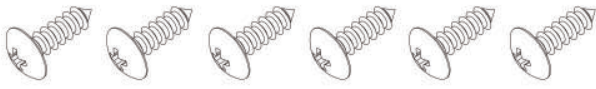

(J3) Screws M4x6



(J4) Screws M8x55

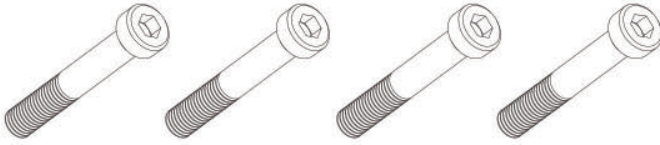

(J5) Washers M8

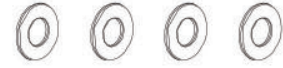

(J6) Screws M8x20



(J7) Screws M12x73

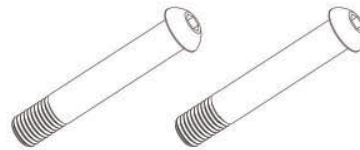

(J8) Washers M12

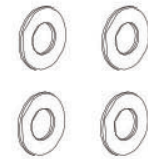

(J9) Nuts M12

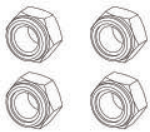

(J10) Screws M12x109



(J13) Screws M8x16

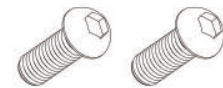

(J14) Screws M5

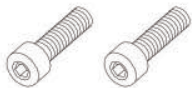

4m/m



5m/m

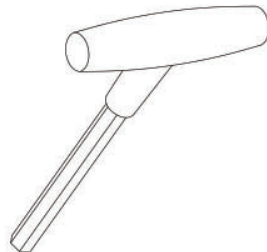

6m/m*2

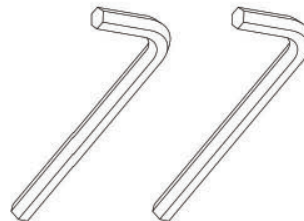

#19



2.3 Assembly

Before assembly, take a close look at the individual assembly steps shown and carry out the assembly in the order given.

① NOTICE

- + First loosely screw all parts together and check that they fit properly. Tighten the screws using the tool only when you are instructed to do so.
- + If you have difficulty recognising the graphics, we recommend that you open and/or download the PDF instructions stored in the webshop on your end device (e.g. smartphone, tablet or PC). There you have the option of zooming in closer. Please note that the Adobe Acrobat Reader programme must be installed on your end device in order to open the file.

Step 1: Unpacking

1. Remove the upper foam parts (1) and (2) and leave the main frame (A) and lower foam parts (3) and (4) in the box.
2. Take out the console, console supporting tube, console mast, pedal supporting bars and hardware bag.

⚠ CAUTION

For safety reasons, the pedal bars are just to be released with the respective control knob once you are asked to do so at the end of the instructions.

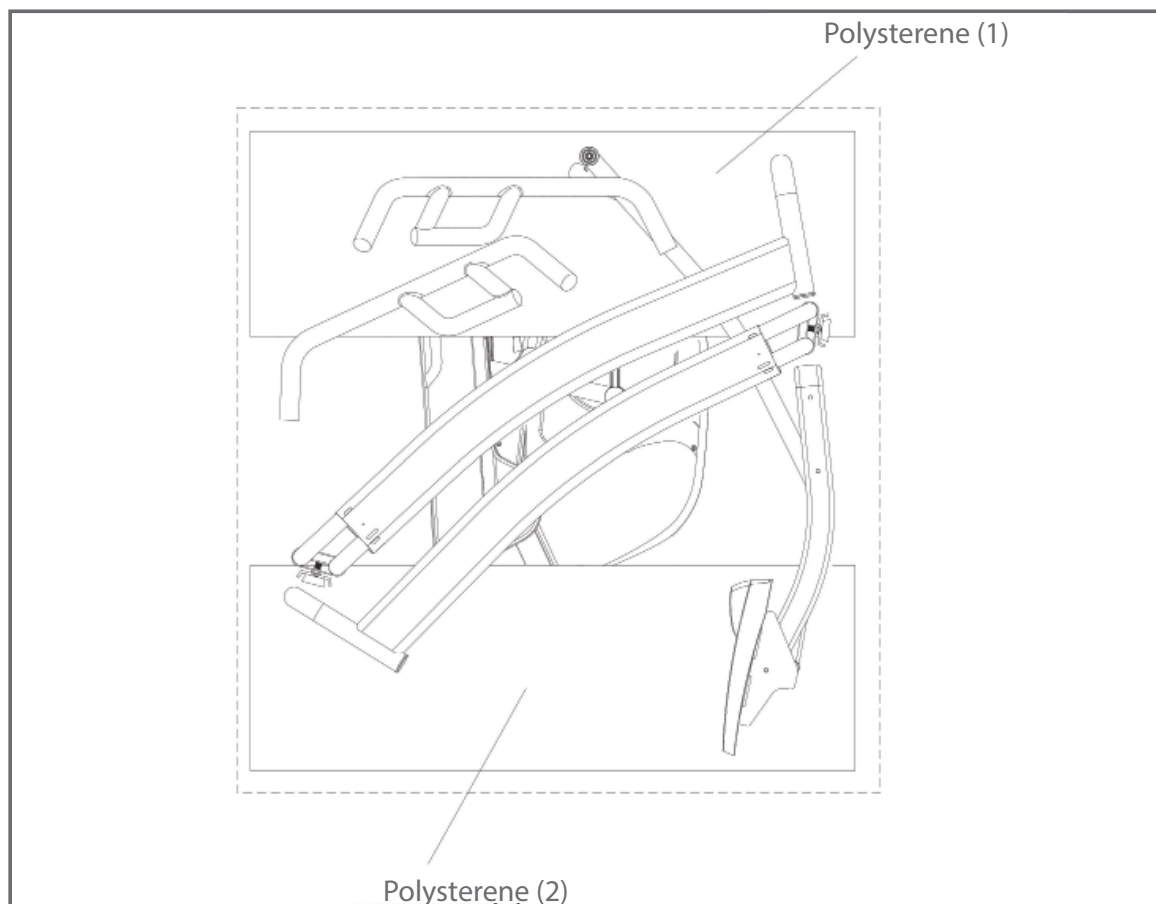

Step 2: Assembly of the main mast (F1)

1. Loosen two screws (F5) from the main frame (A) and two screws from the main mast (F1).
2. Connect the main mast (F1) with the main frame (A) with the previously loosened four screws (J1).
3. Tighten the screws.

NOTICE

Before you continue with step 3 of the assembly, make sure that the four screws (J1) are tightened.

Tool: 6mm Allen key

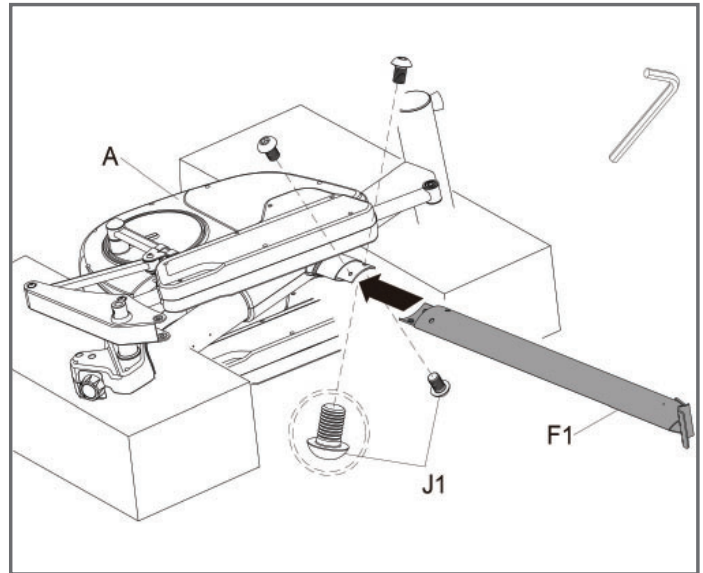

Step 3: Assembly of the side bar cover sets (L+R)

1. Mount the right side bar cover (R1) with a screw (J2) on to the cover (R1).
2. Follow steps 2.1 to 2.4 in order to tighten the side bar cover sets.
 - 2.1. Connect the covers (R1 & R2) on the right connection bar (C2).
 - 2.2. Connect the cover (R3) to the bar (C2).
 - 2.3. Connect the cover (R4) to the bar (C2).
 - 2.4. Secure the covers with the screw (J3) first and then with two screws (J2) as illustrated.
3. Repeat the same steps as described before in order to assemble the left side bar cover set.
4. Tighten the screws.

Tool: 4mm (Phillips screwdriver)

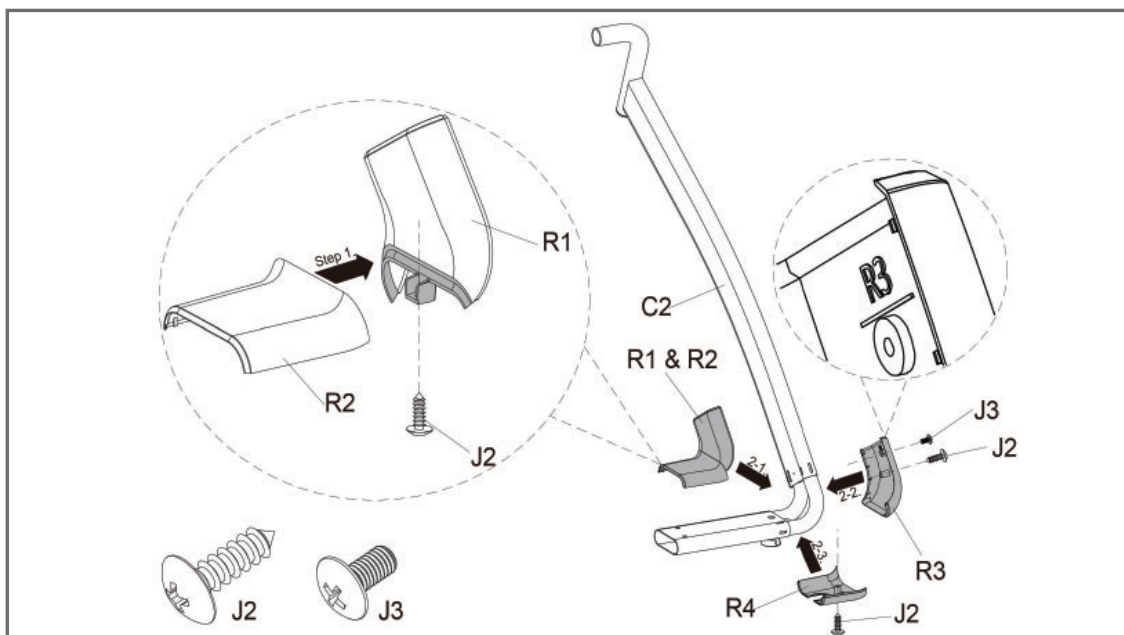

Step 4: Assembly of the right side bar (C2)

1. Mount the right side bar (C2) on the main frame (A) with a screw (J8) on top (figure A) and two screws (J5) including washers (J5) with the bracket (F2) on the bottom (figure B).

► **ATTENTION**

Do not tighten the screws (J6 and J4) completely yet.

2. Raise the main frame (A) with two people and remove the foam (see figure on the right).

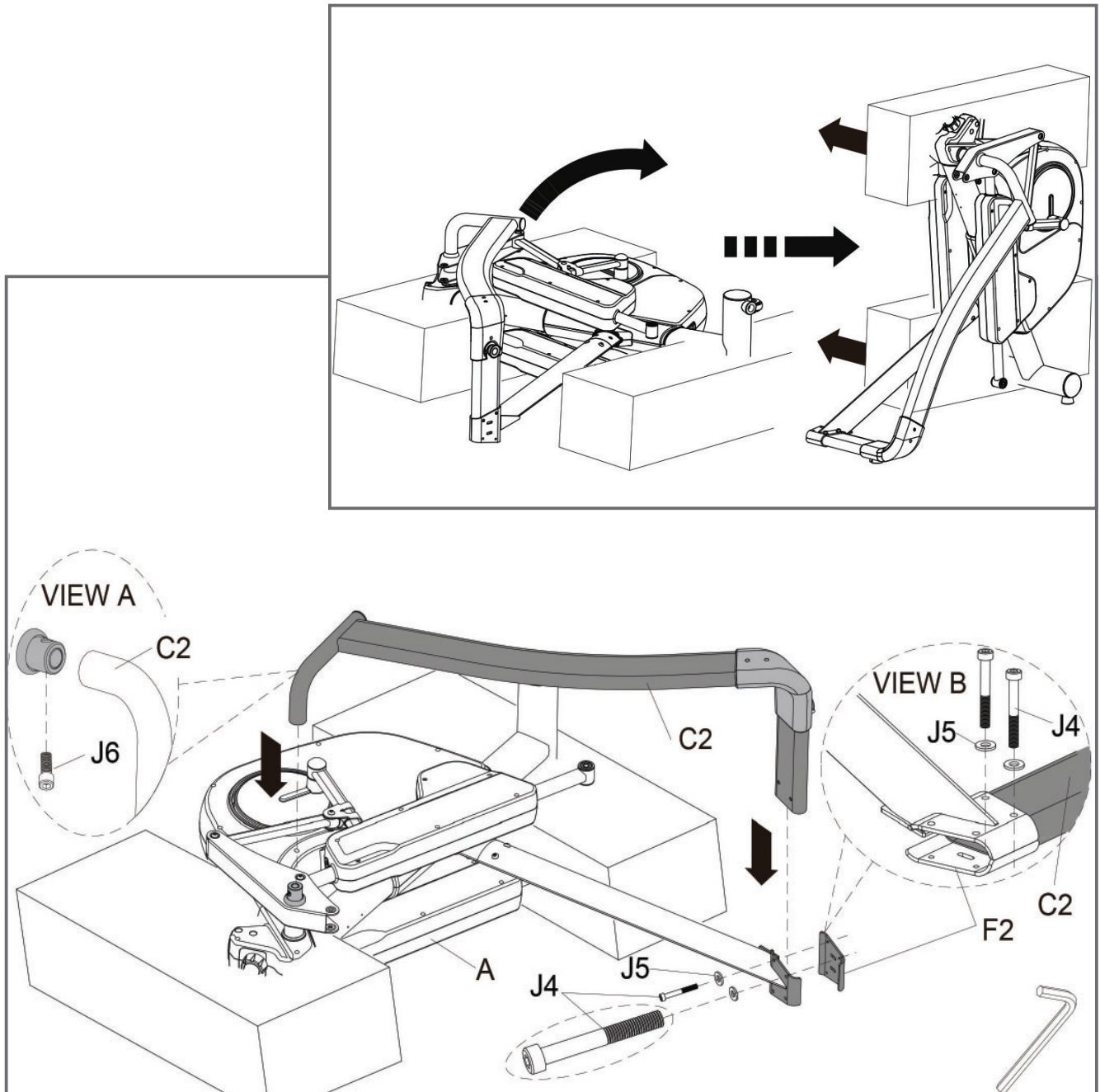

Step 5: Assembly of the left side bar (C1) and covers

1. Connect the left side bar (C1) on the main frame (A) with a screw (J6) on top and two screws (J2) and the bracket (F2) on the bottom.
2. Now you can tighten all of the screws from the previous steps (J6, J4).

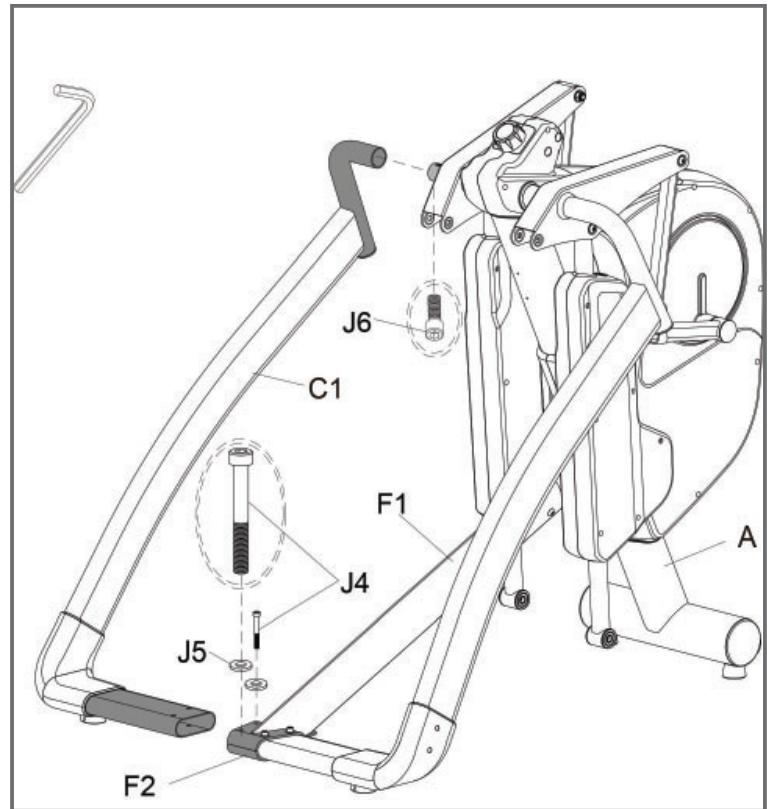

Step 6: Assembly of the pedal bars

1. Connect the right pedal bar (B2) on the top with the main frame (A) and mount it with the nuts (J9), washers (J8) and screws (J3) as in figure C.
2. Mount the pedal bar on the bottom of the main frame with a bolt (J5), a washer (J8) and a nut (J9) as in figure D.
3. Tighten the bolts (J5) and the nuts (J9); see figure E.
4. Repeat the process for the left pedal bar (B1).

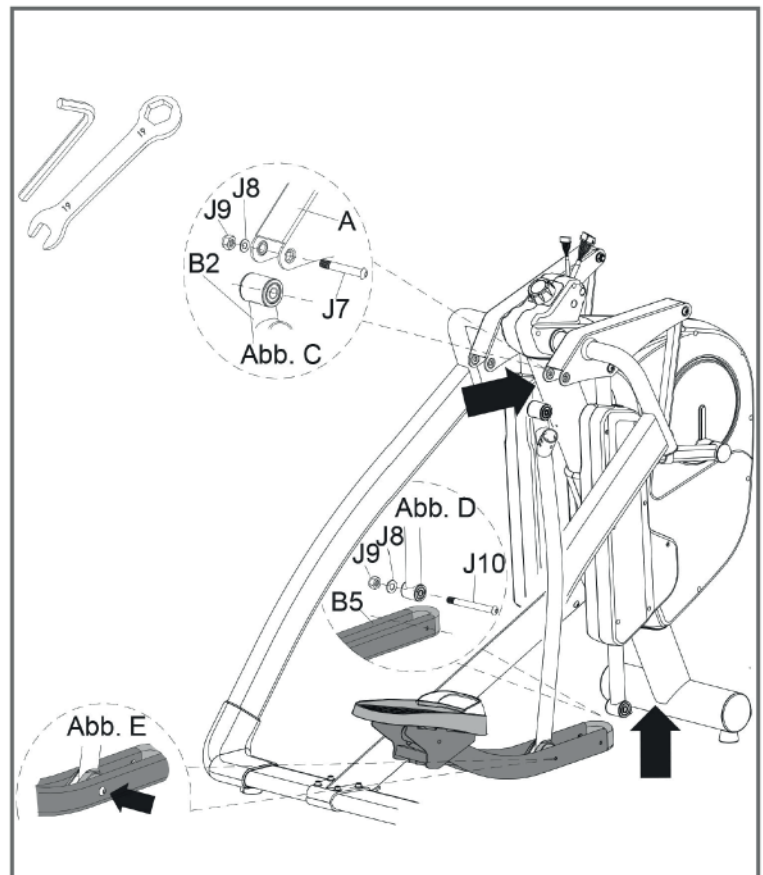

Step 7: Assembly of the handles

1. Loosen the six pre-mounted screws (J12 and J11) from the left handle (E1).
2. Connect the left handle (E1) with the main frame (A) by tightening all screws (J12 and J11) with two 6mm Allen keys; see figure F.
3. Repeat the process for the right handle (E2).

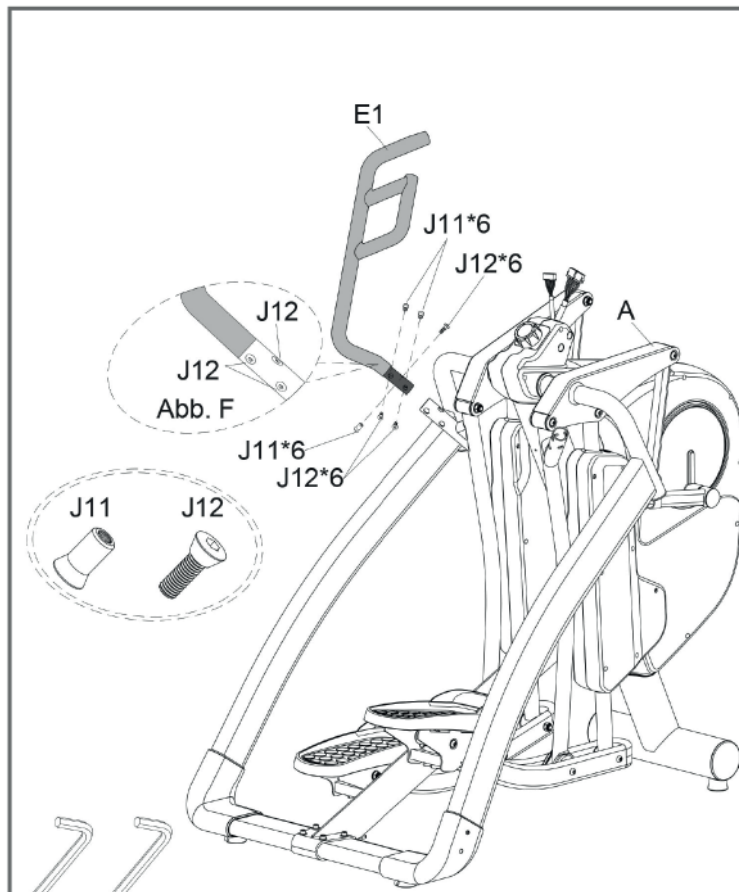

Step 8: Assembly of the console mast and the bottle holder

1. Connect the cable (D1 and D2) from the console mast (D) with the cables (A1 and A2) from the main frame (A).

► **ATTENTION**

Pay attention to not pinch the cables.

2. Mount the console mast (D) on the main frame (A) with two screws (J3) and two pre-mounted screws (J13); see figure G.
3. Mount the bottle holder (H) on the main frame (A) with two screws (J14).
4. Tighten the screws.

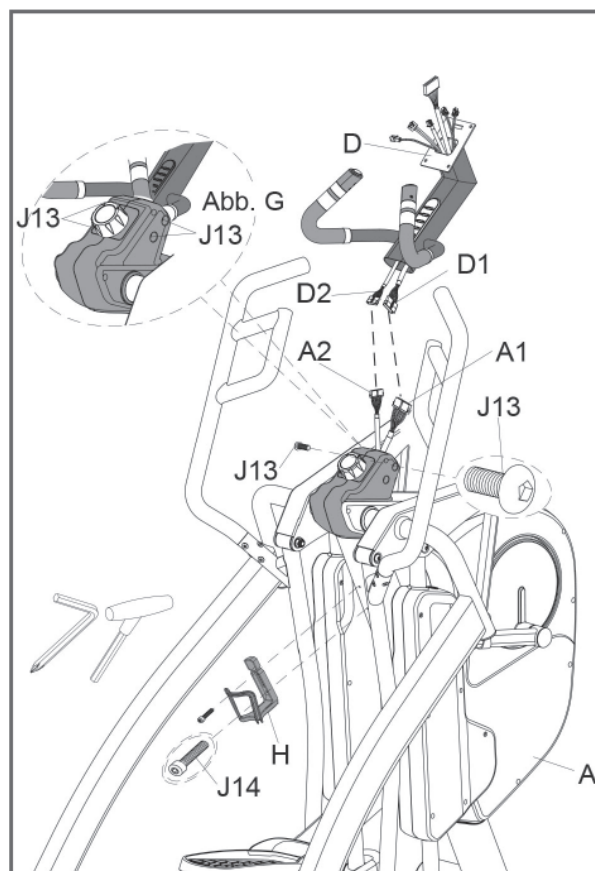

Step 9: Assembly of the console

1. Loosen the four pre-mounted screws (G1) from the console (G).
2. Connect the console cables (D1, D2, D14 & D16) and the heart rate cable (D4) from the console mast with the console.

NOTICE

Make sure that the cables are properly connected with each other. Slide the excess cable into the casing and the console mast (D).

ATTENTION

Pay attention to not pinch the cables.

3. Mount the console (G) on the console mast (D) with the four screws (G1).
4. Tighten the screws.

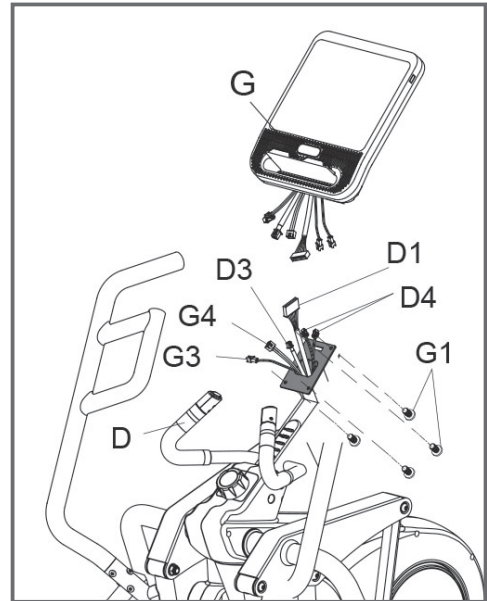

Step 10: Locking the pedal bars (B1 and B2)

CAUTION

- + The pedal bars should always be locked if the equipment is not being used.
- + Never lock the pedal bars if the equipment is still moving, but rather only when the equipment has come to a complete standstill.

To do this, turn the knob (A3) to the "LOCK" position in order to lock the pedal bars (B1 and B2) and avoid possible injuries.

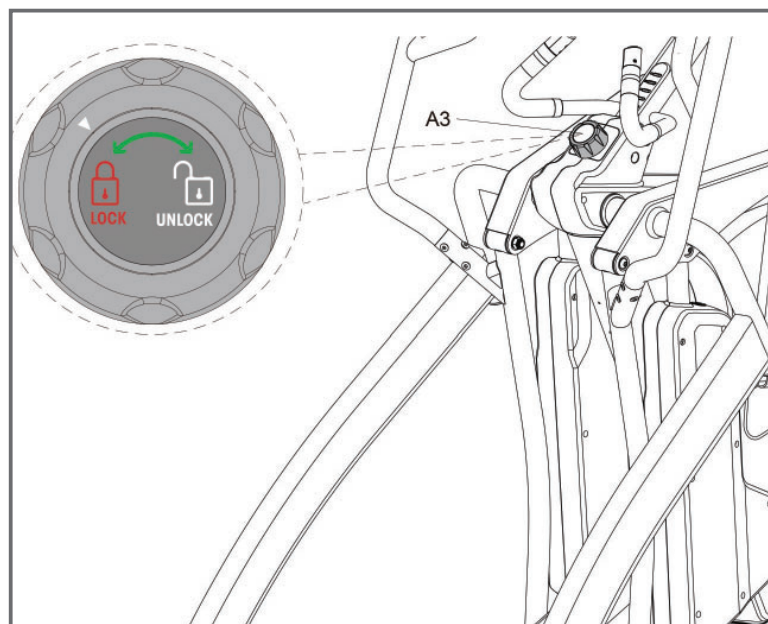

Step 11: Function buttons to adjust the stride length:

1. There is a button on the left and right small handles of the console mast. The left button has the following function: The fine, infinitely variable reduction of the current stride length. The right button has the following function: The fine, infinitely variable increase of the current stride length.
2. If the stride length is reduced, the DOWN signal on the function button will light up in green. If the stride length is increased, the UP signal on the function button will light up in red.

NOTICE

The button for adjustments will not react as long as the stride length is being changed through the button and the LED light is blinking. The button only works if the LED light is illuminated. If there are disruptions while training, simply press any stride length adjustment button and the training can be continued.

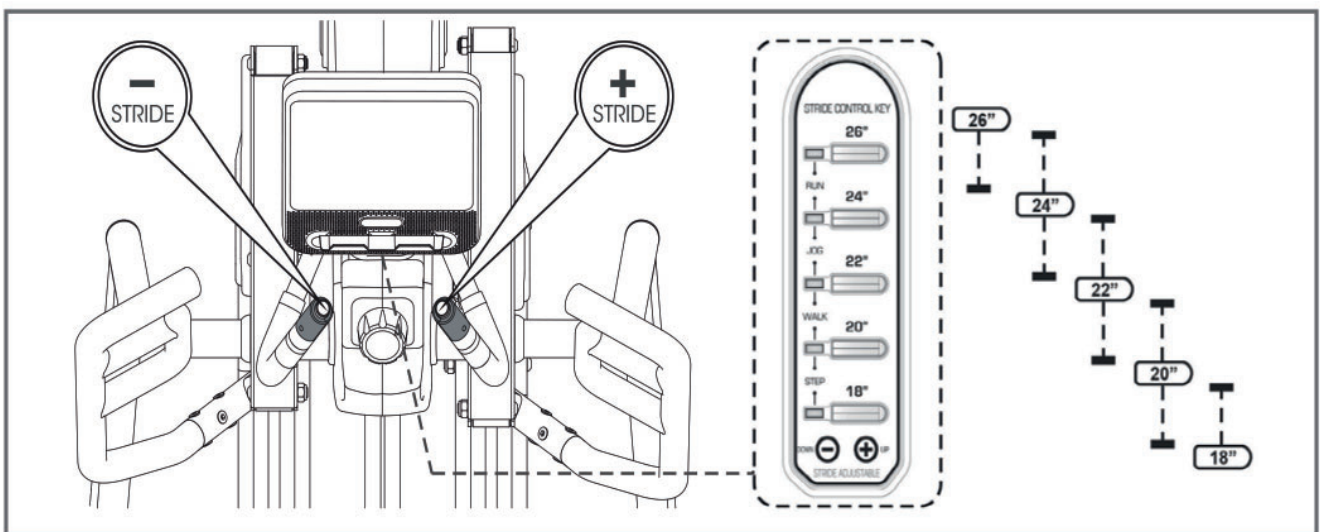

Step 12: Setting the stride length via the incline motor

Corresponding to personal requirements, the stride length, as shown on the LED display, can be set or changed to 18", 20", 22", 24" or 26". There are five quick selection buttons to set the stride length. Press one of the 18" - 26" buttons to set the desired stride length. You can change the stride length at any time during training. The selected stride length is displayed through the blue LED light.

There are different reasons for a user wanting to change the stride length. First because of the height. A user who is smaller than 1.65m could feel more comfortable with a stride length of 18" (approx. 46 cm) to 22" (approx. 56 cm), while a user who is taller than 1.65 cm could feel more comfortable with a stride length of 22"(approx. 56 cm) to 26" (approx. 66 cm), because they can compensate for their stride length.

Furthermore, a user must adjust the stride length with higher speeds in order to compensate for their normal stride length while jogging/running. Another reason why a user may want to change the stride length during training is so that different muscle groups can be worked; a short stride length is demanding for different muscles in the legs and body than a long stride length. A stride length of 18" (approx. 46 cm) can be compared with a shorter kick motion and a stride length of 26" (approx. 66 cm) with a lunge without high stress, which would cause the same movement on a flat surface.

During training, adjusting the resistance or doing squats while holding on to the handle bars helps to isolate these muscles.

ⓘ NOTICE

- + There is no right or wrong stride length for every usage. Select the stride length where you feel the most comfortable.
- + If the stride length motor is activated, you will hear how the motor unlocks and gets set. As soon as the motor has reached the desired stride length, you will hear a click and the motor will lock into the corresponding position.

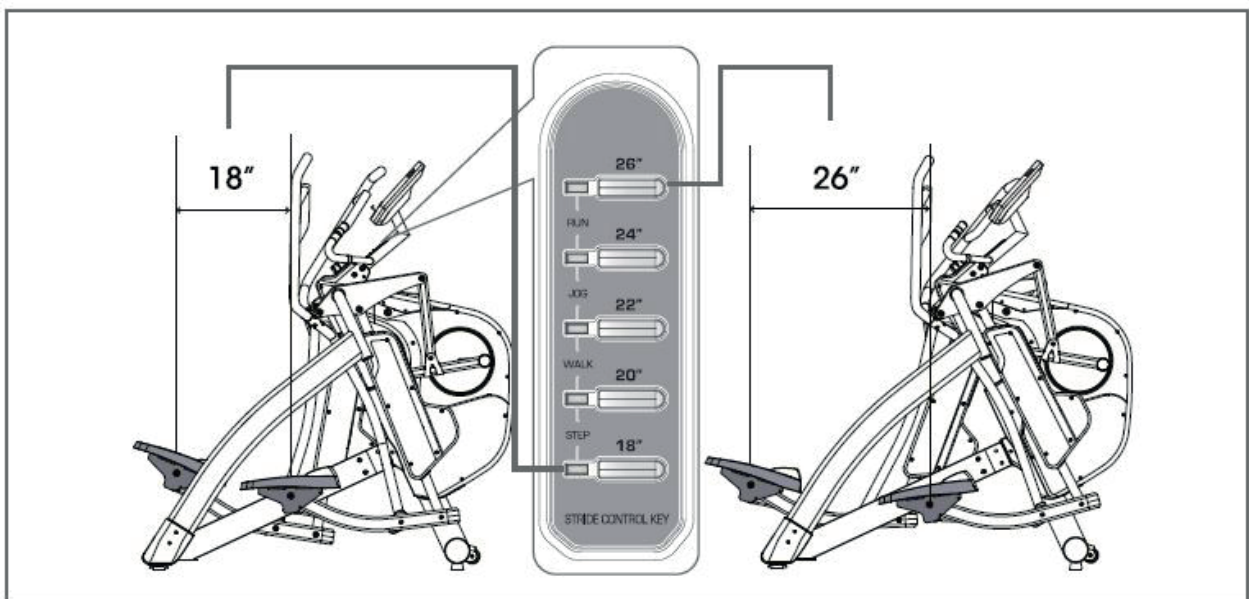

Step 13: Alignment of the feet

If the floor is uneven, you can stabilize the equipment by turning the two setting screws under the main frame.

1. Lift the equipment on the desired side and rotate the setting screws under the main frame.
2. Rotate the screws clockwise in order to remove them and to raise the equipment.
3. Rotate them counterclockwise in order to lower the equipment.

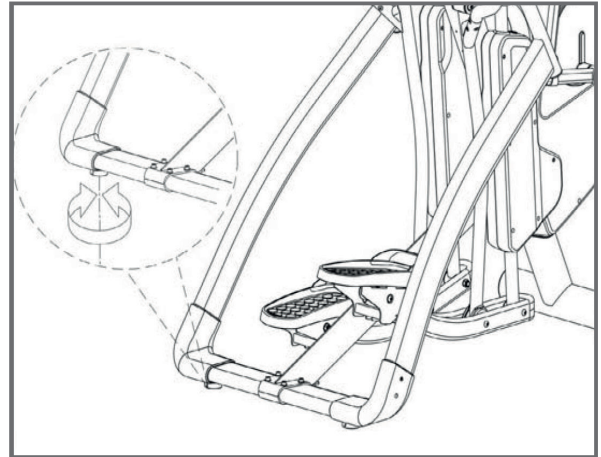

Step 14: Connecting the equipment to the mains supply

▶ ATTENTION

The equipment must not be connected to a multiple socket, otherwise it cannot be guaranteed that the equipment will be supplied with sufficient power. Technical errors can result.

1. Plug the cable into the socket on the main frame.
2. Plug the power plug into a wall outlet that complies with the instructions in the chapter on electrical safety.

ⓘ NOTICE

The overload switch protects from short circuits. The button jumps out in case of overload. Turn the power switch off and then on again to restart the equipment

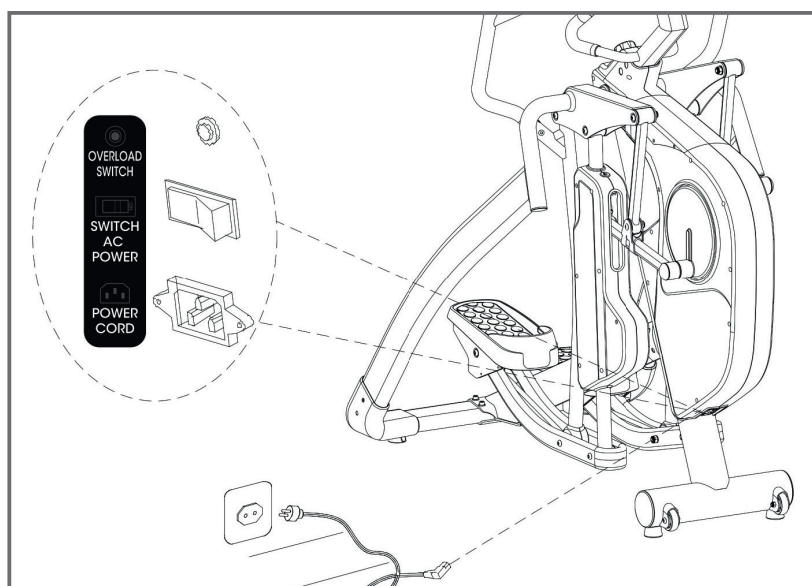

Correctly Getting On and Off

1. To get on, grip the handles with both hands and first step onto the left pedal with your left foot or onto the right pedal with your right foot and then place your foot onto the other pedal.
2. To get off, grip the handles with both hands and place one foot next to the equipment and then the other foot.

3 OPERATING INSTRUCTIONS

① NOTICE

- + Familiarise yourself with all the functions and setting options of the device before starting training. Have the proper use of this product explained to you by a specialist.
- + Always start your training with low intensity and increase evenly and gently. End your training with a cool-down phase. If you are unsure, please consult your physician.

3.1 Console Display



TIME	Display range: 0:00–99:59 Setting range: 0–99 (Minuten)
SPEED	Display range: 0.0–99.9 (km/ml)
RPM	Display range: 0–999
CALORIES	Display range: 0–999 Setting range: 0–990
PULSE	Display range: 0–230 Setting range: 0–230
WATT	Display range: 0–999 Setting range: 30–400
LOAD	Display range: 1–16 Setting range: 1–16
DISTANCE	Display range: 0–99.9 Setting range: 0–99.0

3.2 Button Functions

QUICK START	<ul style="list-style-type: none"> + This button is used to switch on the console. + When the console is power saving mode, the Quick Start button can be used to activate the console + The Quick Start programme can be started with this key.
--------------------	---

3.3 Switching On and Initial Settings

1. Press the Quick Start button to turn on the console.

The main menu opens.

2. Tap on the time and date.
3. Turn on automatic time and date detection or select the appropriate time zone in which you are located.

ⓘ NOTICE

Make sure that the function for automatic time and date detection is switched off. If this function is switched on, it will light up turquoise.

4. Enter the time and date manually. To do this, first select a city in your time zone in the fourth row and, if necessary, set the time in the row above. Then set the current date in the second row.
5. Now connect the device to your Wi-Fi by returning to the settings and tapping Wi-Fi to connect to your network.

ⓘ NOTICE

If you receive the message "Connected, no Internet" although you are successfully connected to the Internet, this is no cause for concern. This is a translation issue and you should still be connected to the Internet. Then wait a few seconds until the message "This network has no Internet access. Stay connected?" appears, check the box "Don't ask again for this network" and confirm with "Yes".

6. You can now activate automatic time and date detection.
7. Finally, carry out an initial update for the console software.
8. Return to the settings.
9. Tap on "Software Update".
10. To update the software, tap on "Update" for TFT.

ⓘ NOTICE

- + The device must not be used or switched off during the update.
- + Check at regular intervals whether another update is available and perform it as described above.

Open the factory settings. Here you can set the following functions:

- + WIFI
- + Screen brightness
- + Volume
- + Language
- + Unit (metric or imperial)
- + Update software and app updates

► **ATTENTION**

The console of this fitness device uses software that is perfectly adapted to the equipment. Please do not make any unauthorised modifications, such as the installation of external apps. This can affect the functionality of the console or even make it unusable. Only install the necessary updates in the Software Updater.

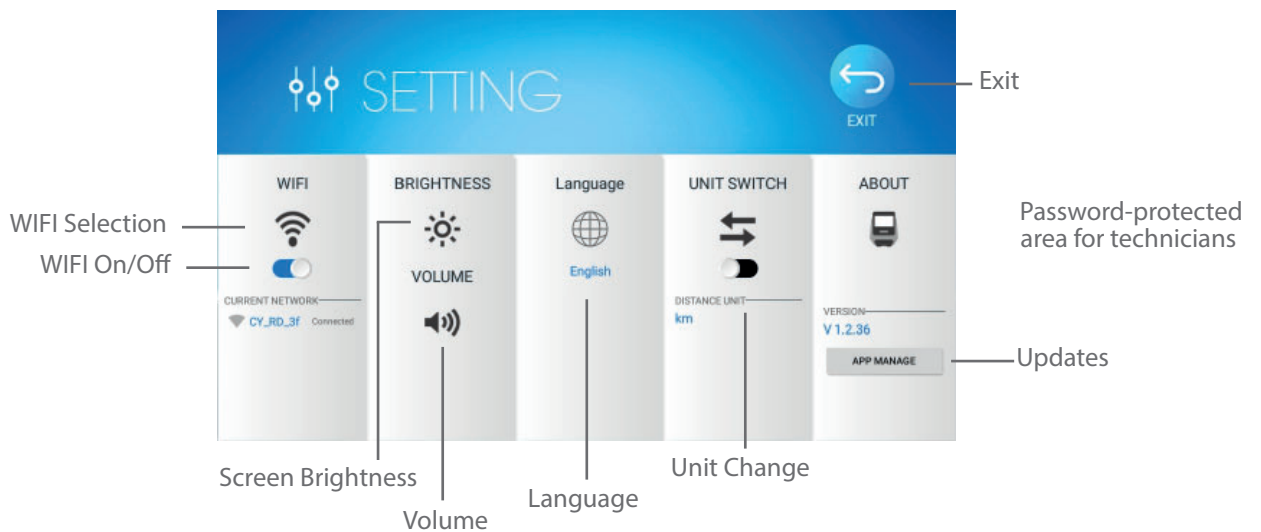
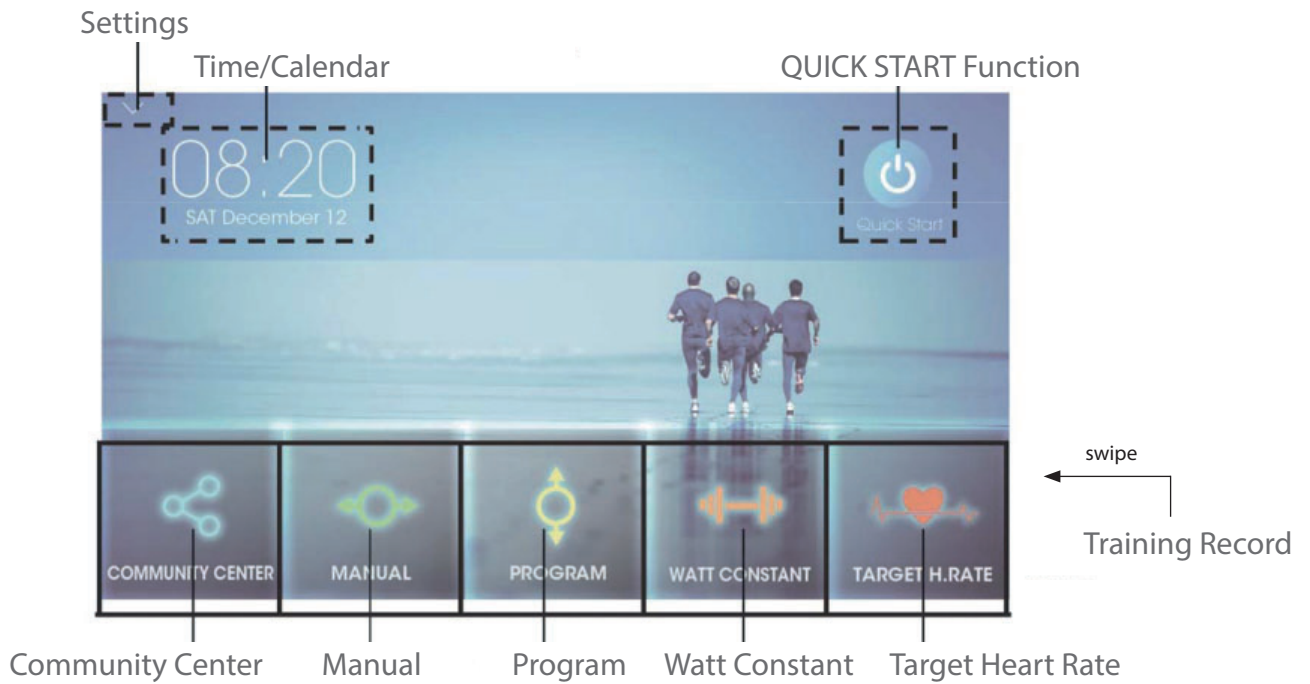

3.4 Programmes

There is a wide range of different programmes available. These include:

- + Quick Start Programme
- + Manual Programmes
- + Pre-set Programmes
- + Watt Programme
- + Heart Rate Controlled Programmes

① NOTICE

The user profile U0 acts as a guest profile. None of your training data is saved. If you use the guest profile U0, you must enter your data for age, height, weight and gender for each programme. The memory function is only available with the user profiles U1-U4. With the user profiles U1-U4, the set data is saved and must not be re-entered.

3.4.1 Quick-Start Programme

1. To start the quick-start programme, tap quick start in the main menu or press the quick start button.

The programme starts.

2. To increase or decrease resistance, tap the arrows.
3. To pause the programme, tap pause.
4. To resume the programme, tap continue.
5. To end the programme and return to the main menu, tap home.

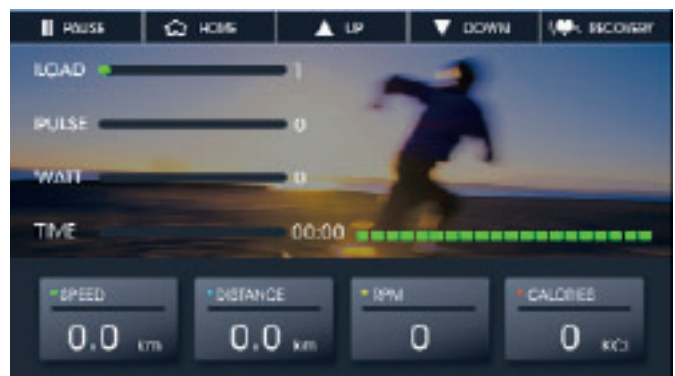

3.4.2 Manual Programme

There are several setting options for the manual programme. You can decide whether you want to train with one or more values.

1. To select the manual programme, tap “Manual” in the main menu.
2. Select one of the user profiles (U0–U4).
3. Set the desired values for time, distance and/or calories.
4. To start the programme, tap start.

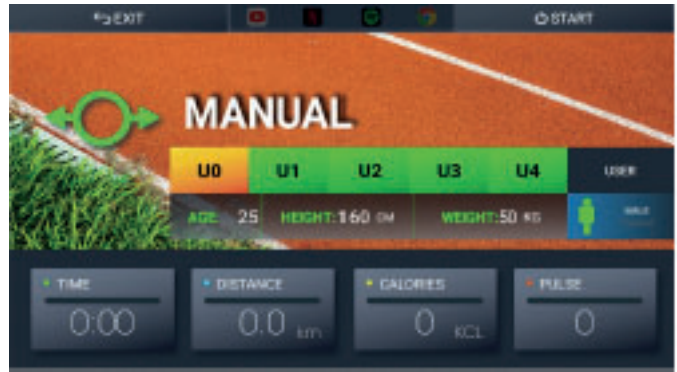

The programme starts. All set values will be counted down.

5. To increase or decrease resistance, tap the arrows.
6. To pause the programme, tap pause.
7. To resume the programme, tap continue.
8. To end the programm and return to the main menu, tap home.

3.4.3 Pre-Set Programmes

1. To select the profile programmes, tap “Program” in the main menu.
2. Select one of the user profiles (U0–U4).
3. Select one of the 60 profile programmes.
4. Set the desired training time.
5. To start the programme, tap start.

The programme starts.

6. To increase or decrease resistance, tap the arrows.
7. To pause the programme, tap pause.
8. To resume programme, tap continue.
9. To end the programme before the set training time has elapsed and return to the main menu, tap home.

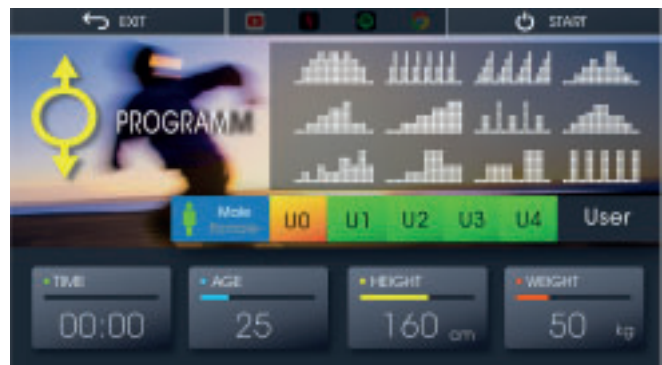

3.4.4 Watt Programme

1. To select the watt programme, tap “Watt constant” in the main menu.
2. Select one of the user profiles (U0–U4).
3. Set the desired training time and wattage.
4. To start the programme, tap start.

The programme starts. At the bottom of the screen it is displayed whether you should pedal faster or slower to maintain the set wattage.

5. To pause the programme, tap pause.
6. To resume the programme, tap continue.
7. To end the programme before the set training time has elapsed and return to the main menu, tap home.

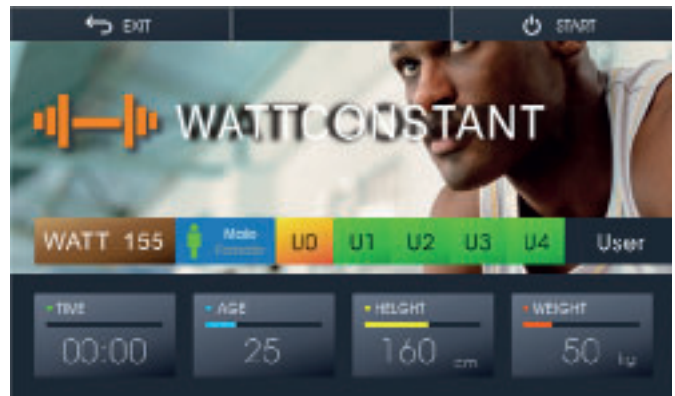

3.4.5 Heart Rate Controlled Programmes

WARNING

Your training equipment is not a medical device. The heart rate measurement of this equipment may be inaccurate. Various factors can affect the accuracy of the heart rate measurement. The heart rate measurement serves only as a training aid.

There are four heart rate programmes available. You can choose between three pre-set target heart rates (55%, 75% or 90% of your maximum heart rate) or TAG where you enter an individual target heart rate manually. Your maximum heart rate is determined by the console depending on your age. For these programmes we recommend using a compatible chest strap.

NOTICE

If you do not use a chest strap, your hands must be placed on the hand pulse sensors permanently during the workout.

1. To select the heart rate controlled programmes, tap “Target H. Rate” in the main menu.
2. Select one of the user profiles (U0–U4).
3. Select either 55%, 75%, 90% or TAG.
- 3.1. If you have selected TAG, now set your individual target value.
4. Set the desired training time.
5. To start the programme, tap start.



The programme starts.

6. To increase or decrease resistance, tap the arrows.
7. To pause the programme, tap pause.
8. To resume the programme, tap continue.

9. To end the programme before the set training time has elapsed and return to the main menu, tap home.

3.5 Recovery Function

After a completed workout, you can use the recovery function to test your recovery heart rate and thus your fitness level.

1. To test your recovery heart rate, tap recovery after training.
2. Grasp the hand pulse sensors with both hands.

After 60 seconds, your result will be displayed as a score (F1 –F6) where F1 is the best and F6 is the worst result.

Exercise regularly to improve your fitness and recovery heart rate.

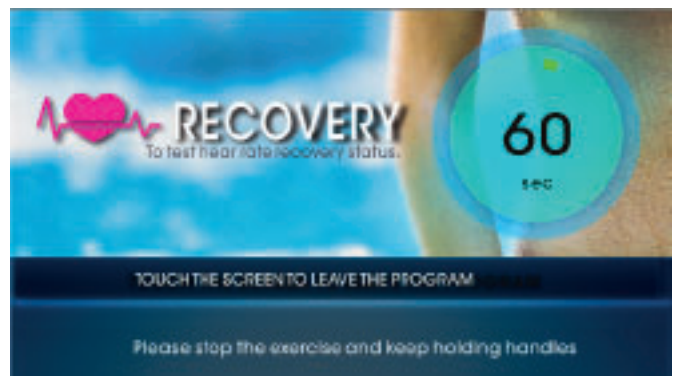

3.6 Training Record

The console offers you the possibility to use a training calendar and thus save your training sessions.

After the workout

When your training programme has finished, “workout” lights up in the display.

1. To save the training data in the training calendar, first tap “save” and then tap “home” to exit.
2. If you do not want to save the training data, tap “home” directly and return to the main menu.



Viewing the training calendar

To view your saved training sessions in the training calendar, swipe left and then tap “Training Record” at the bottom right of the main menu. A calendar of the current month is displayed.

NOTICE

You can switch back and forth between the months by swiping your finger left and right.

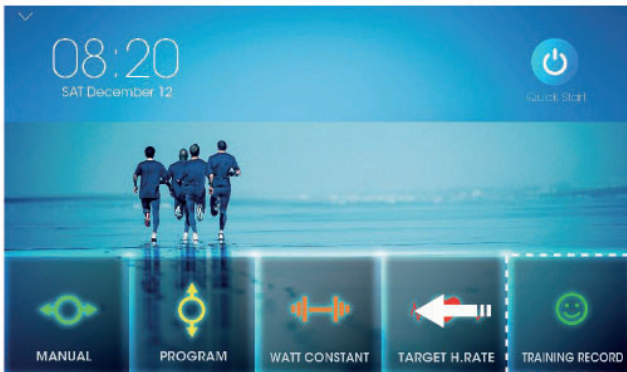

Where the calendar is coloured orange, a training session has been saved on that day. Tap on the corresponding day to view the more detailed training details. You can also delete the saved training data by tapping on the bin icon.



3.7 Multimedia and Software Updates

► ATTENTION

Check your TFT-console regularly for possible software updates. If available, make sure to carry out the updates soon. If the updates are not carried out over a longer period of time, this can lead to technical problems with the console.

To make sure the pre-installed apps are working correctly, they must be updated regularly as well. Follow the instructions on the screen to perform the updates.

Please note: The system is set up only for the pre-installed apps. Do not install any additional apps as their proper functionality can not be guaranteed. The installation of other apps might cause technical issues.

① NOTICE

- + The pre-installed apps are produced and provided by external manufacturers. Changes and availability within these apps might occur. Fitshop does not take any responsibility and can not be held liable for the availability, functionality or contents of these apps.
- + When the console is in MULTIMEDIA mode, it cannot enter power saving mode. If the console is not in use, please exit MULTIMEDIA mode and return to the main menu. Outside MULTIMEDIA mode, the console will enter power saving mode after 5 minutes.

In the media area you have access to various apps. These include:

- + YouTube
- + Netflix
- + Spotify
- + Chrome
- + iRoute
- + Kinomap

3.7.1 Retrieving Apps from the Main Menu

This way only the Quick-Start programme can be used

1. Tap Communication Centre in the Main Menu.
2. Select any app.
3. Tap the arrow on the left side of the screen.
4. Tap Quick Start and the programme starts.

3.7.2 Access to Apps During Your Workout

NOTICE

The access to apps during the training is only possible within the manual programme or one of the profile programmes.

1. Start a desired programme.
2. To use an app during your workout, pause the programme for a moment and tap the desired app at the top of the screen.
3. Tap Continue and the app will open.

NOTICE

It may take a moment for the app to open.

4. To continue your workout, tap the arrow on the left side of the screen and press the Quick Start button.

The selected app now runs simultaneously with the running programme.

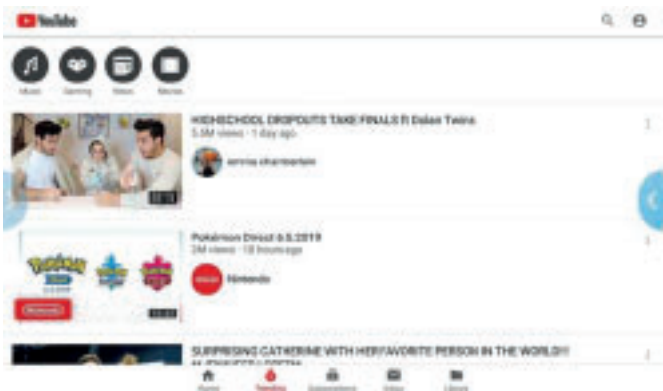

4.1 General Instructions

⚠ WARNING

- + The storage location should be chosen so that improper use by third parties or children can be prevented.
- + If your equipment does not have transportation wheels, the equipment must be disassembled before transportation.

▶ ATTENTION

- + Make sure that the equipment is protected from moisture, dust and dirt in the selected storage location. The storage location should be dry and well ventilated and have a constant ambient temperature between 10°C and 35°C.

4.2 Transportation Wheels

▶ ATTENTION

If you want to transport your equipment over particularly sensitive and soft floor coverings, such as parquet, planks or laminate, lay out the transport route with cardboard or similar to avoid possible floor damage.

1. Stand behind the equipment and lift it until the weight is transferred to the transportation wheels. After that, you easily can move the equipment to a new position. For long transport distances the equipment should be disassembled and safely packed.
2. Select the new location by following the instructions in the section 1.4 of this manual.

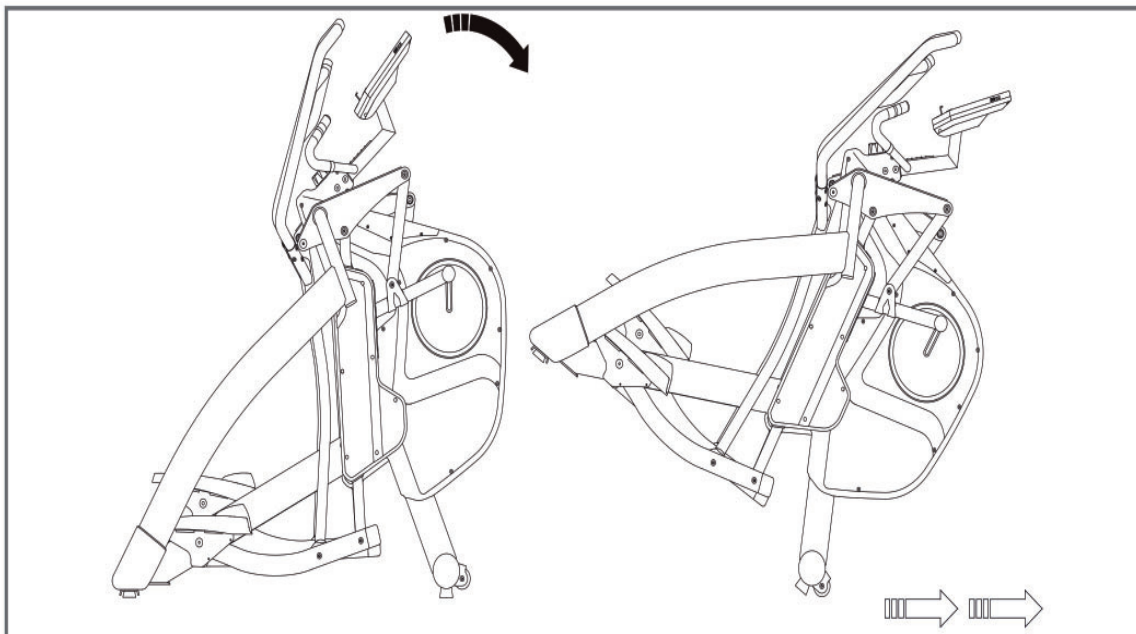

5.1 General Instructions



WARNING

- + Do not make any improper changes to the equipment.



CAUTION

- + Damaged or worn components may affect your safety and the life of the equipment. Therefore, immediately replace damaged or worn components. In such a case, contact the contract partner. The equipment must not be used until it has been repaired. If necessary, use only original spare parts.

ATTENTION

- + In addition to the instructions and recommendations for maintenance and care given here, additional service and/or repair work may be necessary; this must only be carried out by authorised service technicians.

5.2 Faults and Fault Diagnosis

The equipment undergoes regular quality controls during production. Nevertheless, faults or malfunctions may occur. Frequently, individual parts are responsible for these disturbances, an exchange is usually sufficient. Please refer to the following overview for the most common errors and how to correct them. If the equipment still does not function properly, contact your contract partner.

Fault	Cause	Solution
Drive disks wobble/ make noises	Drive disk loose	Tighten nut (pay attention to left-hand / right-hand thread)
Display is blank/is not working	Loose cable connections	Check cable connections
Equipment wobbles	Equipment is not level	Align the feet
Creaking noises on the stepping area	Loose screws on stepping area	Tighten the screws on the stepping area
Creaking noises	Screw connections loosened or too tight	Check screw connections
Squeaking noises on the guide rails	Guide rails or rollers dirty or guide rails dry	Clean the guide rails and then lubricate them with a suitable lubricant
Software problems	Software version not up to date	<ul style="list-style-type: none"> + Check whether there is an update for the software (TFT) and carry it out. + If the problems persist, contact your contract partner.

No pulse display	<ul style="list-style-type: none"> + Sources of interference in the room + unsuitable chest strap + Wrong position of chest strap + Chest strap defective or battery empty + Pulse display defective 	<ul style="list-style-type: none"> + Eliminate sources of interference (e.g. mobile phone, WLAN, lawn mower and vacuum cleaner robot, etc. ...) + Use a suitable chest strap (see RECOMMENDED ACCESSORIES). + Reposition chest strap and/or moisten electrodes + Changing batteries + Check if pulse display by hand pulse possible
------------------	---	--

5.3 Error Codes and Troubleshooting

The electronics of the equipment continuously carries out tests. In case of deviations, an error code appears on the display and normal operation is stopped for your safety.

Please contact the contract partner for technical support

5.4 Maintenance and Inspection Calendar

To avoid damage from sweat, the equipment must be cleaned with a damp towel (no solvents!) after each training session.

The following routine tasks must be performed at the specified intervals:

Part	Weekly	Monthly	Quarterly
Display console	C	I	
Slide rails*		C	
Lubrication of slide rails and moving parts*			I
Plastic covers	C	I	
Screws and cable connections		I	
Legend: C = clean; I = inspect			

*Make sure to always clean the slide rails and moving parts before re-lubricating.

6 DISPOSAL

At the end of its operational life, this equipment cannot be disposed of in normal household waste. Instead, it must be disposed of via an electricals recycling centre. Further information can be obtained from your local authority's recycling service.



The materials can be recycled as per their symbols. Through the reuse, recycling of materials or other forms of recovery of old equipment, you make an important contribution to the protection of the environment.

7 RECOMMENDED ACCESSORIES

To make your training experience even more efficient and pleasant, we recommend that you add suiting accessories to your fitness equipment. For elliptical cross trainers this could for example be a **floor mat**, which makes your fitness equipment stand more securely and also protects the floor from sweat or **silicone spray** to keep moving parts in good shape.

If you have purchased a fitness machine with pulse training and want to train your heart rate, we strongly recommend that you use a compatible **chest strap**, as this ensures optimum transmission of the heart rate.

Our range of accessories offers the highest quality and makes training even better. If you would like to find out more about compatible accessories, please go to the detail page of the product in our webshop (the easiest way is to enter the article number in the search field above) and go to the recommended accessories on this page. Alternatively, you can use the QR-code provided. Of course, you can also contact our customer service: by telephone, e-mail, in one of our branches or via our social media channels. We will be happy to advise you!



chest strap



floor mat



silicone spray



chest strap contact gel

8.1 Serial Number and Model Name

In order to provide you with the best possible service, please have the model name, article number, serial number, exploded drawing and parts list ready. The corresponding contact options can be found in chapter 10 of this operating manual.

NOTICE

The serial number of your equipment is unique. It's located on a white sticker. The exact position of this sticker is shown in the following illustration.



Enter the serial number in the appropriate field.

Serial number:

Brand / Category:

Model Name:

Article Number:

8.2 Parts List

No.	Name	Qty.	No.	Name	Qty.
A	MAIN FRAME	1	A28	SCREW M3x10	2
A1	SENSOR WIRE 900mm	1	A29	SCREW M8x10	2
A2	CONTROLLER WIRE 500mm	1	A30	TRANSPORTATION WHEEL	2
A3	KONB	1	A31	SCREW M12x53	4
A4	CONNECTION SLICE 40 (4T)	4	A32	PRESSING PIPE	1
A5	INCLINE MOTOR SENSOR WIRE	2	A33	WASHER $\Phi 10 \times \Phi 23 \times 2T$	3
A8	INCLINE MOTOR CONTROL BOX	1	A34	BEARING 6200 (MRB)	2
A9	SCREW M5x10	2	A35	SCREW M10x30	1
A10	ADAPTOR	1	A36	JSHAPE SCREW M6	1
A11	DC WIRE 600mm	1	A37	WIRE (AC POWER SWITCH TO POWER CORD)	1
A12	SOCKET	2	A38	WASHER M6x $\Phi 16 \times \Phi 29.2 \times 2T$	1
A13	NUT	1	A39	GROUND WIRE	1
A14	SCREW M3x8	4	A40	POWER CORD	1
A15	SENSOR WIRE 100mm	1	A41	FLYWHEEL $\Phi 327$	1
A15-1	SENSOR WIRE HOUSING	1	A42	NUT 3/8"	2
A15-2	SENSOR WIRE HOUSING SCREW	1	A43	TENSION CABLE 400mm	1
A16	MOTOR	1	A44	SCREW M5x10	4
A17	WIRE (OVERLOAD SWITCH TO AC POWER SWITCH)	1	A45	TURING PLATE	2
A18	BEARING 6005zz (TPX)	2	A46	CRANK	2
A19	BRAKE DEVICE (3T)	1	A47	BEARING NUT	1
A20	SCREW M6x43	1	A47-1	BUSH $\Phi 25.2 \times \Phi 29.2 \times 54.5 \text{mm}$	1
A21	SCREW M8x16	1	A47-2	BUSH $\Phi 25.2 \times \Phi 29.2 \times 5 \text{mm}$	1
A22	WASHER M10	2	A48	SCREW M8x25	4
A23	OVERLOAD SWITCH	1	A49	AXLE $\Phi 25 \times 160 \text{mm}$	1
A24	"WIRE (OVERLOAD SWITCH TO AC POWER SWITCH)"	1	A50	MAGNETIC $\Phi 15 \times 7$	1
A25	POWER CONNECTION WIRE	1	A51	BELT WHEEL $\Phi 360$ (J10)	1
A26	SWITCH AC POWER	1	A52	BELT 530 (1355mm) Xj8	1
A27	POWER CORD SOCKET	1	A53	NUT M8	14
			A54	OSCILLATING AXLE BASE (R)	1
			A55	OSCILLATING AXLE BASE (L)	1

A56	HANDLEBAR SUPPORTING CO-VER	2	A95	SCREW 5/32"x3/4" (M4x19mm)	12
A57	BEARING 6905 (TPX)	2	A96	NUT M6	2
A58	END CAP Φ 4"	2	A97	SIDE DECORATION HOUSING SET (L)	2
A59	FIX CUSHION Φ 50TPR	2	A98	SIDE DECORATION HOUSING SET (R)	2
A60	WASHER M6x2Tx Φ 19	2	A99	FRONTSIDE DECORATION COVER	2
A61	SCREW3/16"x5/8	2	A100	SCREW M4x20	8
A62	FRONT CONNECTING SHAFT	2	A101	END CAP	4
A63	END CAP	1	A102	SMALL CHAIN COVER (L)	1
A64	BUSH Φ 12.1x Φ 16x20mm	4	A103	MAIN CHAIN COVER (L)	1
A65	CLIP (36)	8	A104	UPPER DECORATION HOUSING	1
A66	BEARING 6004 (TPX)	2	A105	SMALL CHAIN COVER (R)	1
A67	BEARING SLEEVE Φ 42x3T	8	A106	MAIN CHAIN COVER (R)	1
A68	SCREW M8x45	2	A107	SCREW M4x12	8
A69	NUT M4	10	A108	MOTOR SENSOR WIRE HOUSING	2
A71	CRANK CONNECTING SHAFT	2	A109	MOTOR SENSOR WIRE HOUSING SCREW	2
A72	BEARING 2203 (MRB)	2	A110	END CAP	2
A73	NUT M10	2	A111	CRANK HOUSING	2
A74	CLIP (R40)	2	A112	SCREW	2
A75	BUSH Φ 12.1x Φ 16x10.5mm	4	A113	SIDE DECORATION HOUSING SCREW	4
A76	SCREW M4x38mm	4	B1	PEDAL SUPPORTING TUBE (L)	1
A77	FLAT KEY 7x7x20mm	2	B2	PEDAL SUPPORTING TUBE (R)	1
A80	FRONT PEDAL SUPPORTING TUBE	2	B3	BEARING SLEEVE	4
A81	WASHER M10x Φ 27x2T	2	B4	BEARING 6201 (TPX)	8
A82	SCREW M10x40mm	2	B5	LOWER PEDAL SUPPORTING TUBE	2
A84	BRAKE	1	B7	PEDAL BRACKET (L)	1
A85	SPRING	1	B8	PEDAL BRACKET (R)	1
A87	AXLE FOR MOTOR PUSH ROD	2	B9	PEDAL REST (L)	1
A89	NYLON SLEEVE	8	B10	PEDAL REST (R)	1
A90	PUSH ROD BRACKET (FRONT)	2	B11	FRONT COVER PEDAL (L)	1
A91	END CAP	1			
A93	PUSH ROD BRACKET (REAR)	2			
A94	SCREW M8x20	8			

B12	CUSHION PAD (L)	1	D3	SENSOR WIRE 300mm	1
B13	PEDAL (L)	1	D4	HANDLE PULSE WIRE	2
B14	SCREW 5/32"x5/8" (M4x15mm)	6	D5	HANDLE PULSE RING Φ31.8x0.9Tx19.5mm	2
B15	SCREW M6x10mm	8			
B16	PEDAL (R)	1	D6	SPACER RING Φ32x30.4	2
B17	CUSHION PAD (R)	1	D7	HANDLE PULSE	4
B18	FRONT COVER PEDAL (R)	1	D8	UPPER HANDLE PULSE HOUSING	2
B19	UPPER CAP FOR PEDAL SUPPORTING 20x60	2	D9	LOWER HANDLE PULSE HOUSING	2
B20	LOWER CAP FOR PEDAL SUPPORTING 20x60	2	D10	HANDLE PULSE RING Φ31.8x0.9Tx30.5mm	2
B21	SCREW 5/32"x1/2"	8	D11	PLASTIC PIPE	2
B22	MIDDLE PEDAL SUPPORTING ROD	2	D12	"FOAM SPACER RING Φ32xΦ25.8x- 10mm"	2
B23	NUT M8	4			
B24	BUSH Φ8x(Φ12+Φ15)	8	D13	SPONG HDR Φ23x3Tx150mm	2
B25	BEARING 6001 (TPX)	4	D14	SENSOR WIRE	1
B27	SCREW M8x45	4	D15	SCREW M3x8	4
B30	SCREW M12x133	2	D16	SENSOR WIRE	1
B31	BUSH Φ15xΦ12.35x90mm	2	D25	SCREW	4
B32	BEARING 6003zz	16	E1	HANDLE BAR (L)	1
B33	BUSH	2	E2	HANDLE BAR (R)	1
B34	PEDAL HOUSING (R)	2	F1	CENTRAL SUPPORTING TUBE	1
B35	PEDAL HOUSING (L)	2	F2	IRON BRACKET	1
B36	SCREW	4	G	CONSOLE	1
B37	PEDAL REINFORCEMENT STRIP	4	G1	CONSOLE SCREW M5x10	4
B38	SCREW	8	G2	STRIDE LED SENSOR BOARD	1
C1	SIDE CONNECTING TUBE (L)	1	H	WATER BOTTLE HOLDER	1
C2	SIDE CONNECTING TUBE (R)	1	J1	SCREW M10x16	4
C3	END CAP	2	J2	SCREW M4x16	6
C4	ADJUSTED NUT	2	J3	SCREW M4x6	2
C5	ADJUSTED END Φ50	2	J4	SCREW M8x55	4
D	CONSOLE SUPPORTING TUBE	1	J5	WASHER M8x18	4
D1	SENSOR WIRE 350mm	1	J6	SCREW M8x20	2
D2	SENSOR WIRE 200mm	1	J7	SCREW M12x73	6

J8	WASHER M12x20	16
J9	NUT M12	16
J10	SCREW M12x109	4
J11	HANDLE BAR SCREW	6
J12	HANDLE BAR SCREW	6
J13	SCREW M8x16	4
J14	WATER BOTTLE HOLDER SCREW	2
L1	SIDE TUBE COVER SET (L1)	1
L2	SIDE TUBE COVER SET (L2)	1
L3	SIDE TUBE COVER SET (L3)	1
L4	SIDE TUBE COVER SET (L4)	1
M4	SCREW	2
N1	BUSH Φ 12.05*17*21.2mm	4
N2	CLIP (R40)	2
N3	BEARING 2203(MRB)	2
N4	SPACER RING (L)	4
N5	SPACER RING (R)	4
N6	SCREW	8
M1	BUSH	6
M2	CLIP R32	8
M3	MOTOR	2
P1	SPRING WASHER M8	4
P2	TOGGLE LOAD -	1
P3	TOGGLE LOAD +	1
R1	SIDE TUBE COVER SET (R1)	1
R2	SIDE TUBE COVER SET (R2)	1
R3	SIDE TUBE COVER SET (R3)	1
R4	SIDE TUBE COVER SET (R4)	1

8.3 Exploded Drawing

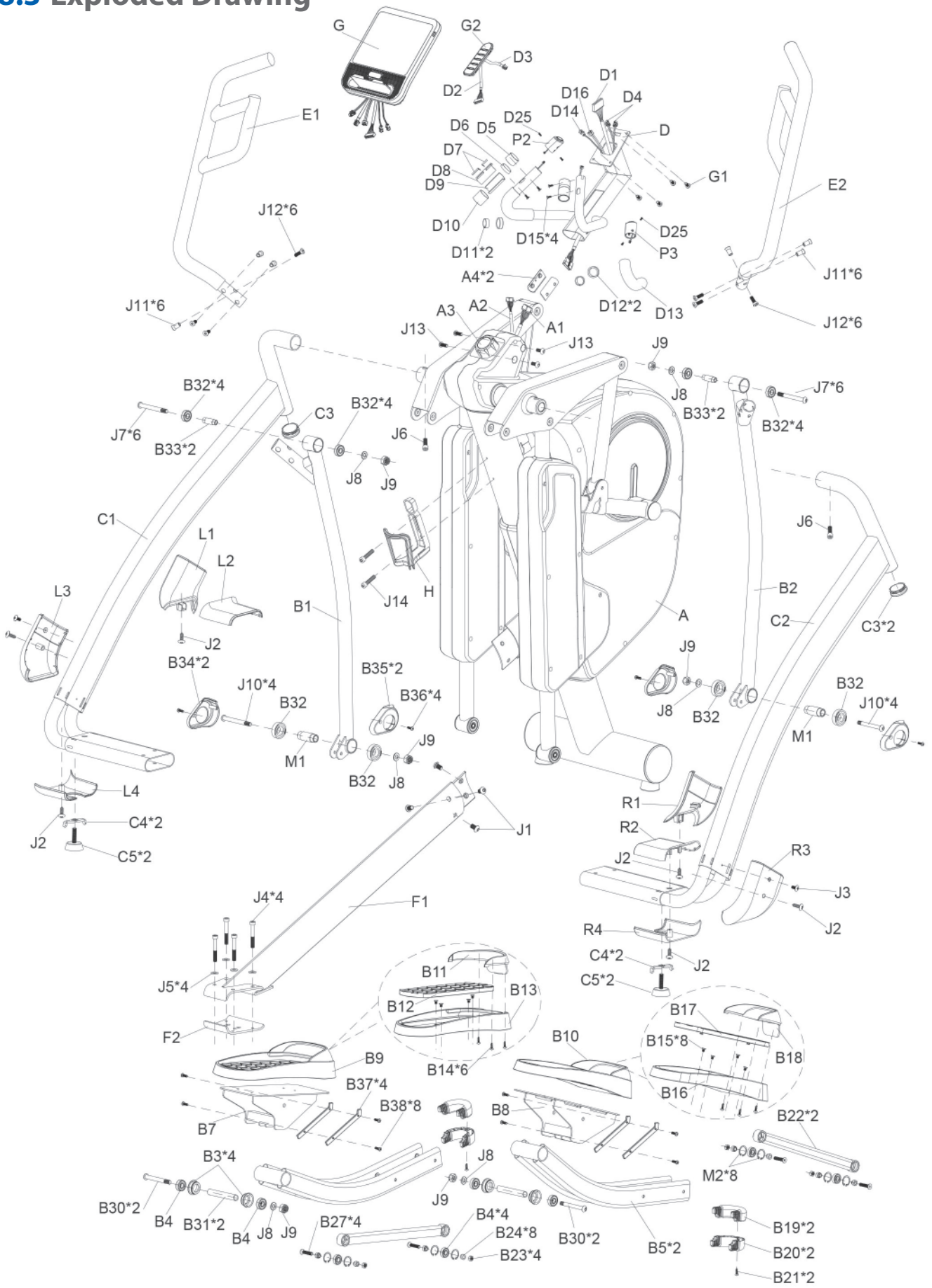

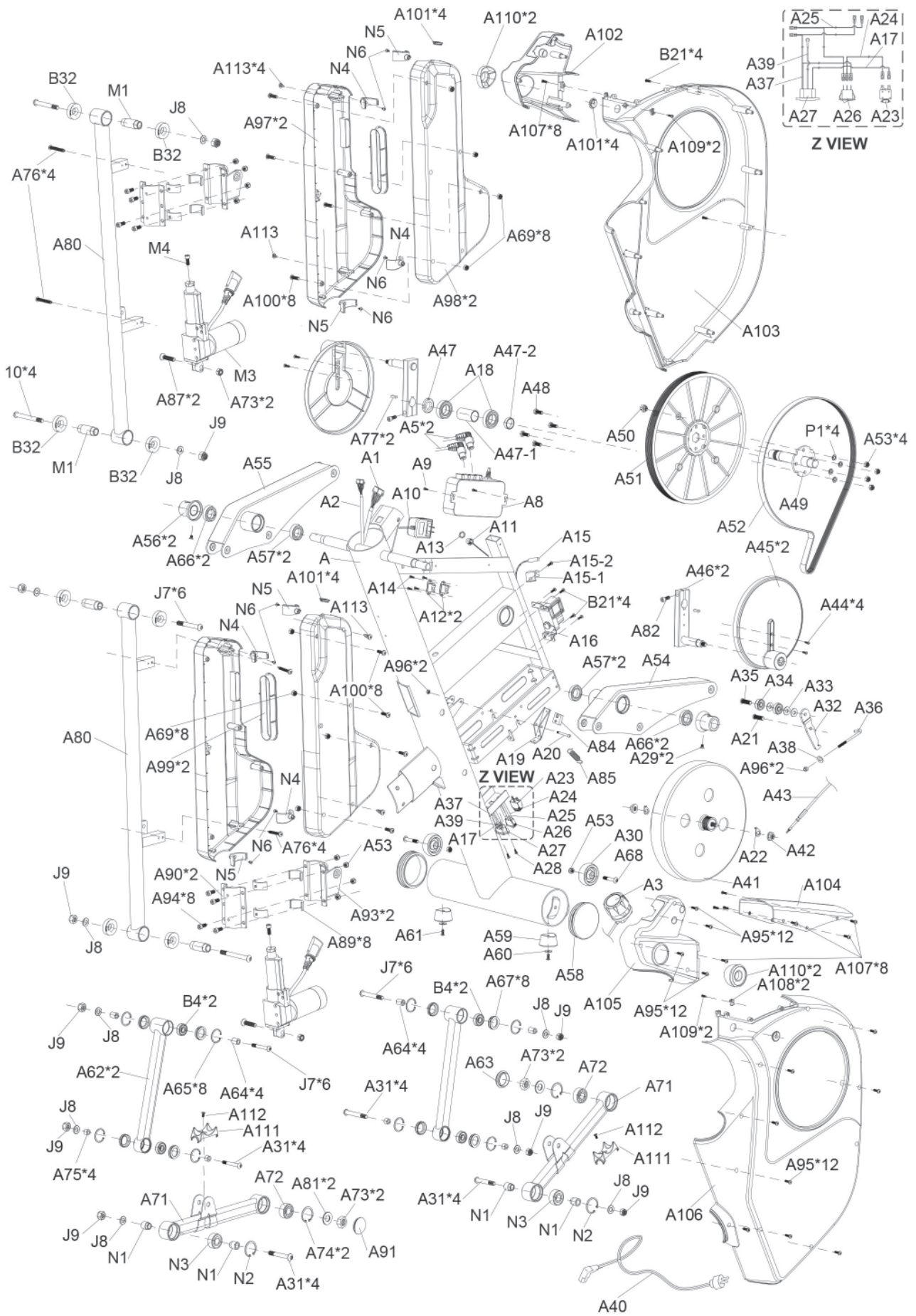

Products from cardiostrong® are subject to strict quality control. However, if a fitness equipment purchased from us does not work perfectly, we take it very seriously and ask you to contact our customer service as indicated. We are happy to help you by phone via our service hotline.

Error Descriptions

Your fitness equipment is developed for long-term, high-quality training. However, should a problem arise, please first read the operating instructions. For further assistance, please contact your contract partner or call our service hotline. To ensure your problem is solved as quickly as possible, please describe the defect as exactly as possible.

In addition to the statutory warranty, we provide a warranty for every fitness equipment purchased from us according to the following provisions.

Your statutory rights are not affected.

Warrantee

The warrantee is the first/original buyer and/or any person who received a newly purchased product as a gift from the original buyer.

Warranty period

The warranty periods, shown on our web shop, begin on delivery of the fitness equipment. The respective warranty periods for your equipment can be found on its product website.

Repair Costs

According to our choice, there will either be a repair, a replacement of individual damaged parts or a complete replacement. Spare parts, that have to be mounted while assembling the equipment, have to be replaced by the warrantee personally and are not a part of repair. After the expiration of the warranty period, the responsibility for parts costs, repair costs, installation costs and delivery costs lies with the warranty holder.

The terms of use are defined as follows:

- + Home use: solely for private use in private households up to 3 hours per day
- + Semi-professional use: up to 6 hours per day (e. g. rehabilitation centres, hotels, clubs, company gyms)
- + Professional use: more than 6 hours per day (e. g. commercial gyms)

Warranty Service

Within the warranty period, equipment which develops faults as a result of material or manufacturing defects, will be repaired or replaced at our discretion. Ownership of equipment or parts of equipment which have been replaced is transferred to us. The warranty period is not extended nor does a new warranty period begin following repair or replacement under the warranty.

Warranty Conditions

For the warranty to be valid, the following steps must be taken:

Please contact our customer service by email or phone. If the product under warranty has to be sent in for repair, the seller bears costs. After expiry of the warranty, the buyer bears the costs of transport and insurance. If the fault is covered by our warranty, you will receive a new or repaired equipment in return.

Warranty claims are invalid in case of damage resulting from:

- + misuse or improper handling
- + environmental influences (moisture, heat, electrical surge, dust, etc.)
- + failure to follow the current safety measures for the equipment
- + failure to follow the operating instructions
- + use of force (e. g. hitting, kicking, falling)
- + interventions which were not carried out by one of our authorized service centres
- + unauthorised repair attempts

Proof of Purchase and Serial Number

Please make sure that you are able to provide the appropriate receipt when claiming on your warranty. So that we can clearly identify the model of your equipment, and for the purposes of our quality control, you will need to give the serial number of your equipment, when contacting the service team. Where possible please have your serial number and your customer number ready when you call our service hotline. It will help us to deal with your request swiftly.

If you cannot find the serial number on your fitness equipment, our service team is at your disposal to offer further information.







































Service outside of the Warranty Period

We are also happy to issue an individual cost estimate if there is a problem with your fitness equipment after the warranty has expired, or in cases which do not fall under the terms of the warranty, e. g. normal wear and tear. Please contact our customer service team to find a quick and cost-effective solution to your problem. In such a case you will be responsible for the delivery costs.

Communication

Many problems can be solved just by speaking to us as your specialist supplier. We know how important it is to you as a user of the fitness equipment to have problems solved quickly and simply, so you can enjoy working out with minimal interruption. For that reason, we also want to resolve your queries quickly and in a straightforward manner. Thus, please always keep your customer number and the serial number of the faulty equipment handy.

10 CONTACT

DE	DK	UK
<p>TECHNIK</p> <p> +49 4621 4210-900</p> <p> +49 4621 4210-698</p> <p> technik@fitshop.de</p> <p> Öffnungszeiten entnehmen Sie unserer Homepage.</p> <p>SERVICE</p> <p> 0800 20 20277 (kostenlos)</p> <p> 04621 4210 - 0</p> <p> info@fitshop.de</p> <p> Öffnungszeiten entnehmen Sie unserer Homepage: https://stg.fit/statit6</p>	<p>TEKNIK OG SERVICE</p> <p> 80 90 16 50</p> <p>+49 4621 4210-945</p> <p> info@fitshop.dk</p> <p> Åbningstider kan findes på hjemmesiden: https://stg.fit/statit7</p>	<p>CUSTOMER SUPPORT</p> <p> 00800 2020 2772</p> <p>+494621 4210 944</p> <p> info@fitshop.co.uk</p> <p> You can find the opening hours on our homepage: https://stg.fit/statitc</p>
	FR	BE
	<p>TECHNIQUE & SERVICE</p> <p> +33 (0) 189 530984</p> <p>+49 4621 42 10 933</p> <p> info@fitshop.fr</p> <p> Vous trouverez les heures d'ouverture sur notre site Internet: https://stg.fit/statit4</p>	<p>TECHNIQUE & SERVICE</p> <p> 02 732 46 77</p> <p>+49 4621 4210 933</p> <p> info@fitshop.be</p> <p> Vous trouverez les heures d'ouverture sur notre site Internet: https://stg.fit/statit8</p>
ES	NL	INT
<p>TECNOLOGÍA Y SERVICIOS</p> <p> 911 238 029</p> <p> info@fitshop.es</p> <p> Consulta nuestro horario de apertura en la página web: https://stg.fit/statit5</p>	<p>TECHNISCHE DIENST & SERVICE</p> <p> +31 172 619961</p> <p> service@fitshop.nl</p> <p> De openingstijden vindt u op onze homepage: https://stg.fit/statit3</p>	<p>TECHNICAL SUPPORT & SERVICE</p> <p> +49 4621 4210-944</p> <p> service-int@fitshop.de</p> <p> You can find the opening hours on our homepage: https://stg.fit/statita</p>
PL	AT	CH
<p>DZIAŁ TECHNICZNY I SERWIS</p> <p> 22 307 43 21</p> <p>+49 4621 42 10-948</p> <p> info@fitshop.pl</p> <p> Godziny otwarcia można znaleźć na stronie głównej: https://stg.fit/statit6</p>	<p>TECHNIK & SERVICE</p> <p> 0800 20 20277 (Freecall)</p> <p>+49 4621 42 10-0</p> <p> info@fitshop.at</p> <p> Öffnungszeiten entnehmen Sie unserer Homepage: https://stg.fit/statitb</p>	<p>TECHNIK & SERVICE</p> <p> 0800 202 027</p> <p>+49 4621 42 10-0</p> <p> info@fitshop.ch</p> <p> Öffnungszeiten entnehmen Sie unserer Homepage: https://stg.fit/statit9</p>

Please find a detailed overview including address and opening hours for all stores of the Fitshop Group in Germany and abroad on the following website:

www.fitshop.com/en/stores

WE LIVE FITNESS

WEBSHOP AND SOCIAL MEDIA

Fitshop is Europe's largest specialist store for home fitness equipment with currently over 70 stores and one of the world's most renowned online mail order companies for fitness equipment. Private customers order via the 25 web shops in the respective national language or have their desired equipment assembled on site. In addition, the company supplies fitness studios, hotels, sports clubs, companies and physio practices with professional equipment for endurance and strength training.

Fitshop offers a wide range of fitness equipment from renowned manufacturers, high-quality in-house developments and comprehensive services, such as a build-up service and sports scientific advice before and after the purchase. The company employs numerous sports scientists, fitness trainers and competitive athletes.

Visit us also on our social media platforms or our blog!

