



## Assembly and Operating Instructions



max. 150 kg



~ 90 Min.



131 kg

L 150 | W 90 | H 166

CSTEX90PLUS.01.06

Art. No. CST-EX90-PLUS

Elliptical cross trainer **EX90 Plus**



# Content

<b>1</b>	<b>GENERAL INFORMATION</b>	<b>7</b>
1.1	Technical Data	7
1.2	Personal Safety	8
1.3	Electrical Safety	9
1.4	Set-Up Place	10
<b>2</b>	<b>ASSEMBLY</b>	<b>11</b>
2.1	General Instructions	11
2.2	Scope of Delivery	12
2.3	Assembly	14
<b>3</b>	<b>OPERATING INSTRUCTIONS</b>	<b>23</b>
3.1	Console Display	23
3.2	Turning On and Setting the Equipment	25
3.3	Programs	25
3.3.1	Quick Start and Manual	25
3.3.2	PROG - Pre-set programs	26
3.3.3	H.R.C. - Heart rate controlled programs	27
3.3.4	H.R.C. - Heart rate controlled programs	27
3.3.5	USER - User defined program	27
3.3.6	WATT - Watt controlled program	27
3.3.7	RECOVERY - Fitness test	27
<b>4</b>	<b>STORAGE AND TRANSPORT</b>	<b>28</b>
4.1	General Instructions	28
4.2	Transportation Wheels	28
<b>5</b>	<b>TROUBLESHOOTING, CARE AND MAINTENANCE</b>	<b>29</b>
5.1	General Instructions	29
5.2	Faults and Fault Diagnosis	29
5.3	Maintenance and Inspection Calendar	30
<b>6</b>	<b>DISPOSAL</b>	<b>30</b>
<b>7</b>	<b>RECOMMENDED ACCESSORIES</b>	<b>31</b>

<b>8</b>	<b>ORDERING SPARE PARTS</b>	<b>32</b>
8.1	Serial Number and Model Name	32
8.2	Parts List	33
8.3	Exploded Drawing	37
<b>9</b>	<b>WARRANTY</b>	<b>39</b>
<b>10</b>	<b>CONTACT</b>	<b>41</b>

**Dear customer,**

thank you for choosing fitness equipment from cardiostrong®. Cardiostrong offers high-quality home fitness equipment that is optimally adapted to the conditions at home. Train at home no matter what the weather or time of the day. cardiostrong fitness equipment offers training programmes and a variety of equipment for all training levels and all training goals. Further information can be found at [www.sport-tiedje.com](http://www.sport-tiedje.com) or [www.cardiostrong.de](http://www.cardiostrong.de). We hope you enjoy your training!

Further information can be found at [www.sport-tiedje.com](http://www.sport-tiedje.com).

**Intended Use**

The equipment may only be used for its intended purpose.

The equipment is suitable for home use and semi-professional use (e.g. hospitals, clubs, hotels, schools, etc.). The equipment is not suitable for commercial or professional use (e.g. fitness studio).

**Disclaimer**



©2010 cardiostrong® is a registered brand of the company SportTiedje GmbH. All rights reserved. Any use of this trademark without the explicit written permission of Sport-Tiedje is prohibited.

Product and manual are subject to change. Technical data can be changed without advance notice.

## ABOUT THIS MANUAL

Please carefully read the entire manual before installation and first use. The manual will help you to quickly set up the system and explains how to safely use it. Make sure that all persons exercising with the equipment (especially children and persons with physical, sensory, mental or motor disabilities) are informed about this manual and its contents in advance. In case of doubt, responsible persons must supervise the use of the equipment.



Due to ongoing changes and software optimisations, the manual may have to be updated. If you notice any discrepancies during assembly or use, please refer to the manual uploaded to the webshop. The latest manual is always available there.

This equipment has been manufactured according to the latest safety knowledge. As far as possible, potential safety hazards which could cause injury have been eliminated. Make sure to carefully follow the instructions and that all parts are securely in place. If required, read through the instructions again to correct any mistakes.

Please pay close attention to the safety and maintenance instructions given here. The contract partner cannot be held liable for damage to health, accidents or damage to the equipment when it is not used in accordance with these instructions.

The following safety instructions may appear in this manual:

► **ATTENTION**

This notice indicates potentially hazardous situations which, if not avoided, may result in property damage.

⚠ **CAUTION**

This notice indicates potentially hazardous situations which, if not avoided, may result in slight or minor injuries!

⚠ **WARNING**

This notice indicates potentially hazardous situations which, if not avoided, may result in death or serious injuries!

⚠ **DANGER**

This notice indicates potentially hazardous situations which, if not avoided, will result in death or serious injuries!

ⓘ **NOTICE**

This notice indicates further useful information.

Retain these instructions in a safe place for future reference, maintenance or when ordering replacement parts.

## 1.1 Technical Data

### LCD display of

- + speed in km/h
- + training time in min
- + training distance in km
- + cadence (rotations per minute)
- + calories burnt in kcal
- + heart rate (when using the hand sensors or a chest strap)
- + Watt
- + resistance level

Resistance system:	electronic magnetic brake system
Resistance level:	16
Watt:	10 - 350 Watt (adjustable in 5-Watt increments)

User memory:	4
Total number of training programs:	19
Manual programs:	1
Pre-set programs:	12
Watt-controlled programs:	1
Heart rate controlled programs:	4
User defined programs:	1

Balance mass:	12 kg
Stride length:	45 - 65 cm
Step width:	11 cm

Electronic step length adjustment:  
45 cm (18"), 50 cm (20"), 55 cm (22"), 60 cm (24"), 65 cm (26")

### Weight and dimensions:

Article weight (gross, including packaging):	135.7 kg
Article weight (net, without packaging):	130.7 kg
Packaging dimensions (L x W x H):	approximately 1410 mm x 1150 mm x 500 mm
Set-up dimensions (L x W x H):	approximately 1495 mm x 900 mm x 1655 mm
Maximum user weight:	150 kg/330 lbs

## 1.2 Personal Safety

### **DANGER**

- + Before you start using the equipment, you should consult your physician that this type of exercise is suitable for you from a health perspective. Particularly affected are persons who: have a hereditary disposition to high blood pressure or heart disease, are over the age of 45, smoke, have high cholesterol values, are overweight and/or have not exercised regularly in the past year. If you are under medical treatment that affects your heart rate, medical advice is absolutely essential.
- + Note that excessive training can seriously endanger your health. Please also note that heart rate monitoring systems can be inaccurate. If you notice any signs of weakness, nausea, dizziness, pain, shortness of breath, or other abnormal symptoms, stop exercising immediately and seek advice from your doctor if necessary.

### **WARNING**

- + This equipment may not be used by children under the age of 14.
- + Children should not be allowed unsupervised access to the equipment.
- + Persons with disabilities must have a medical license and must be under strict observation when using the equipment.
- +
- + The equipment is strictly for use by one person at a time.
- + Keep your hands, feet and other body parts, hair, clothing, jewellery and other objects well clear of moving parts.
- + During use, wear suitable sports clothing rather than loose or baggy clothing. When wearing sports shoes, make sure they have suitable soles, preferably made of rubber or other non-slip materials. Shoes with heels, leather soles, studs or spikes are unsuitable. Never exercise barefoot.

### **CAUTION**

- + If your equipment needs to be connected to the power supply with a mains cable, make sure that the cable is not a potential tripping hazard.
- + Make sure that nobody is within the range of motion of the equipment during training so as not to endanger you or other persons.

### **ATTENTION**

- + Do not insert any objects of any kind into the openings of the device.



## 1.3 Electrical Safety

### **DANGER**

- + In order to reduce the risk of an electric shock, always unplug the equipment from the mains socket immediately after your workout, before assembly or dismantling, and before maintenance or cleaning. Do not pull on the cable.

### **WARNING**

- + Do not leave the equipment unattended while the mains cable is plugged into the mains socket. During your absence, the mains cable must be removed from the mains socket to prevent improper use by third parties or children.
- + If the mains cable or plug is damaged or defective, contact your contract partner. Until repair, the equipment must not be used.

### **ATTENTION**

- + The equipment requires a mains connection of 220-230 V with 50 Hz mains voltage.
- + The equipment may only be connected directly to an earthed socket using the supplied mains cable. Extension cables must conform to VDE guidelines. Always completely unwind the mains cable.
- + The socket must be protected by a fuse with a minimum fuse rating of "16 A, slow blow".
- + Do not make any changes to the mains cable or the mains plug.
- + Keep the mains cable away from water, heat, oil and sharp edges. Do not route the mains cable underneath the equipment or under a carpet or rug, and do not place any objects on top of it.
- + If your purchased item is equipped with a TFT console, software updates must be carried out regularly. Follow the instructions on the console to perform the update(s).
- + The software systems on gym equipment with TFT consoles are set up only for the pre-installed apps. Do not install any additional apps.

### **NOTICE**

- + The pre-installed apps on TFT consoles are produced and provided by external manufacturers. Sport-Tiedje does not take any responsibility for the availability, functionality or contents of these apps.

## 1.4 Set-Up Place

### **WARNING**

- + Do not place the equipment in main corridors or escape routes.

### **CAUTION**

- + Choose a location in which to place the equipment such that there is enough free space/clearance to the front, the rear and to the sides of the equipment. Make sure that you leave at least 30 cm on each side of the equipment and at least 15 cm in front of and behind the equipment as a training zone. This is the minimum required area in order to safely use the equipment. The recommended free zone around the equipment should be at least 60 cm on each side and 45 cm in front of and behind the equipment.
- + The training room should be well ventilated during training and not be exposed to any draughts.
- + Choose the place in which to set up the equipment such that there is enough free space/clearance to the front, the rear and to the sides of the equipment.
- + The set-up and mounting surface of the equipment should be flat, loadable and solid.

### **ATTENTION**

- + The device may only be used in one building, in sufficiently tempered and dry rooms (ambient temperatures between 10°C and 35°C). The equipment should not be used outdoors or in rooms with high humidity (over 70%) like swimming pools.
- + A floor protective mat/equipment underlay can help to protect high-quality floor coverings (parquet, laminate, cork, carpets) from dents and sweat and can help to level out slight unevenness.

### 2.1 General Instructions



#### **DANGER**

- + Do not leave any tools, packaging materials such as foils or small parts lying around, as otherwise there is a danger of suffocation for children. Keep children away from the equipment during assembly.



#### **WARNING**

- + Pay attention to the instructions attached to the equipment in order to reduce the risk of injuries.



#### **CAUTION**

- + Do not open the packaging when it is lying on its side.
- + Ensure to have sufficient room for movement in each direction during assembly.
- + The assembly of the equipment must be carried out by at least two adults. If in doubt, seek the help of a third technically skilled person.



#### **ATTENTION**

- + To prevent damage to the equipment and the floor, assemble the equipment on a mat or packaging board.



#### **NOTICE**

- + In order to make the assembly as simple as possible, some screws and nuts to be used can already be pre-assembled.
- + Ideally, assemble the equipment at its later set-up place.

## 2.2 Scope of Delivery

The scope of delivery consist of the following parts. At the beginning, check whether all parts and tools belonging to the device are included in the scope of delivery and whether damage has occurred. In the event of complaints, the contractual partner must be contacted directly.

### ⚠ CAUTION

If parts of the scope of delivery are missing or damaged, the assembly must not be carried out.

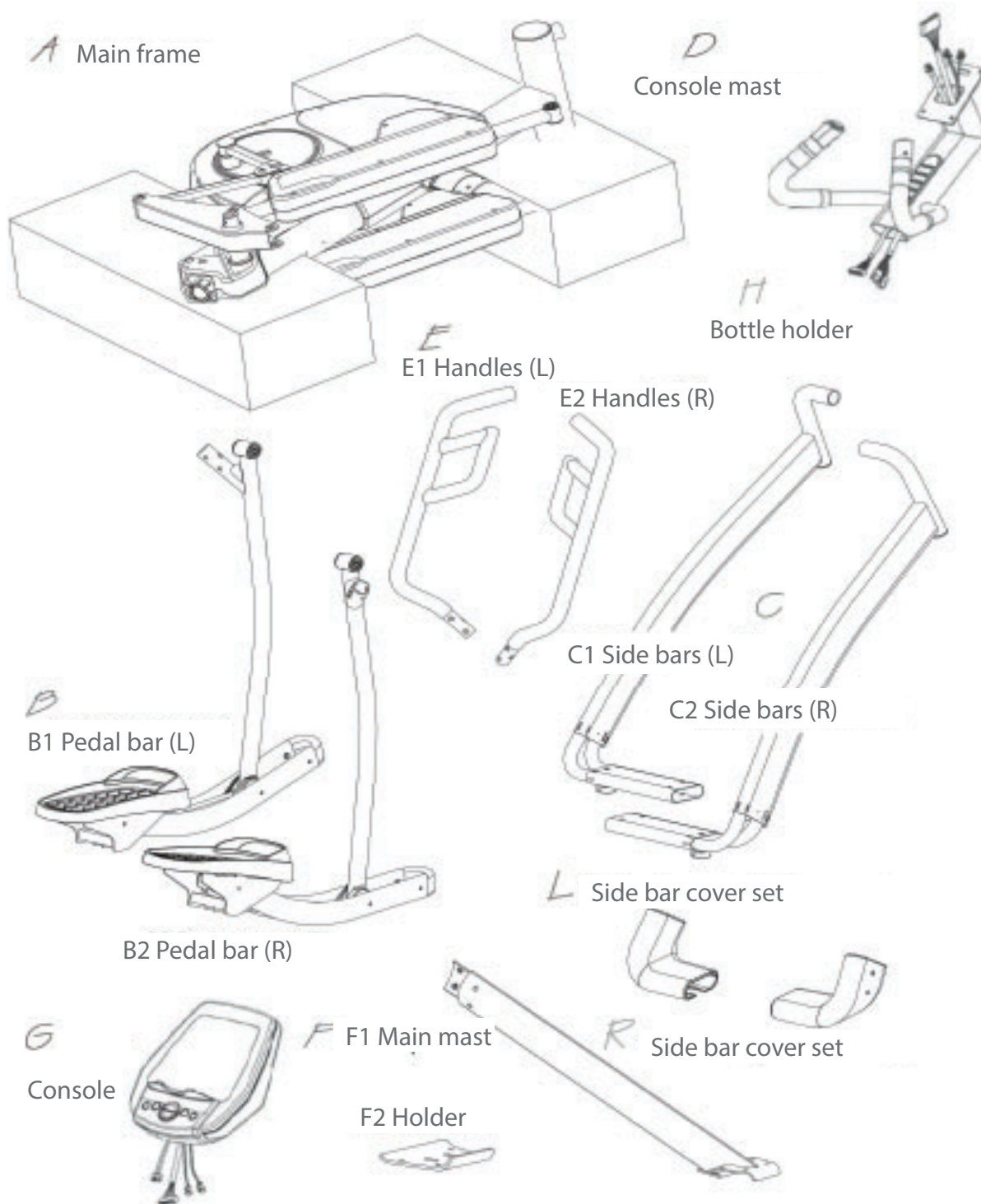

(J2) Screws M4x16



(J3) Screws M4x6



(J4) Screws M8x55



(J5) Washers M8



(J6) Screws M8x20



(J7) Screws M12x73

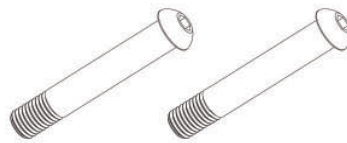

(J8) Washers M12

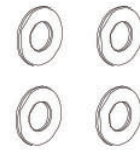

(J9) Nuts M12

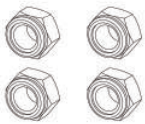

(J10) Screws M12x109

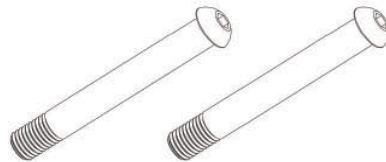

(J13) Screws M8x16

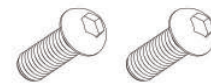

(J14) Screws M5

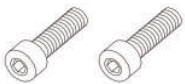

4m/m



5m/m

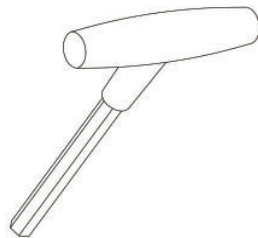

6m/m\*2

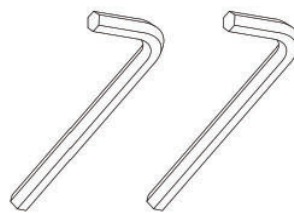

#19



## 2.3 Assembly

Before assembly, take a close look at the individual assembly steps shown and carry out the assembly in the order given.

### ① NOTICE

- + First loosely screw all parts together and check that they fit properly. Tighten the screws using the tool only when you are instructed to do so.
- + If you have difficulty recognising the graphics, we recommend that you open and/or download the PDF instructions stored in the webshop on your end device (e.g. smartphone, tablet or PC). There you have the option of zooming in closer. Please note that the Adobe Acrobat Reader programme must be installed on your end device in order to open the file.

### Step 1: Unpacking

1. Place box flat on the ground, remove cover.

### ① NOTICE

If no box is existing, continue with step 2

2. Unpack handles (E), side supporting bars (C), pedal bars (B) and operating instructions.
3. Remove the upper foam parts (1) and (2) and take out the console, console supporting tube, console mast, pedal supporting bars and hardware bag. First leave the main frame (A) and lower foam parts (3) and (4) in the box.

### ① NOTICE

For safety reasons, the pedal bars are just to be released with the respective control knob once you are asked to do so at the end of the instructions.

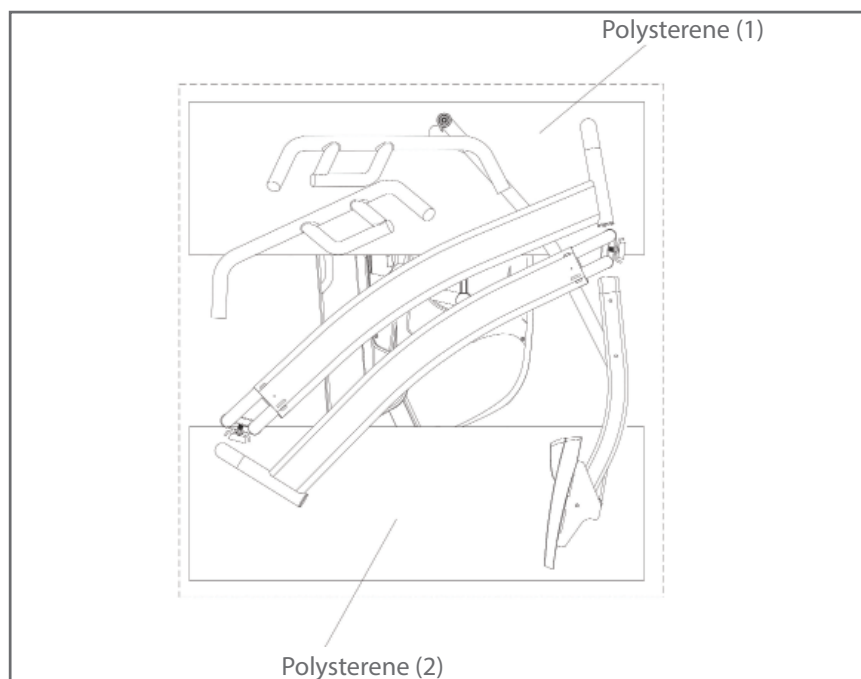

## Step 2: Assembly of the main mast (F1)

1. Loosen two screws (F5) from the main frame (A) and two screws from the main mast (F1).
2. Connect the main mast (F1) with the main frame (A) with the previously loosened four screws (J1).

### ⓘ NOTICE

Before you continue with step 3 of the assembly, make sure that the four screws (J1) are tightened.

Tool: 6mm Allen key

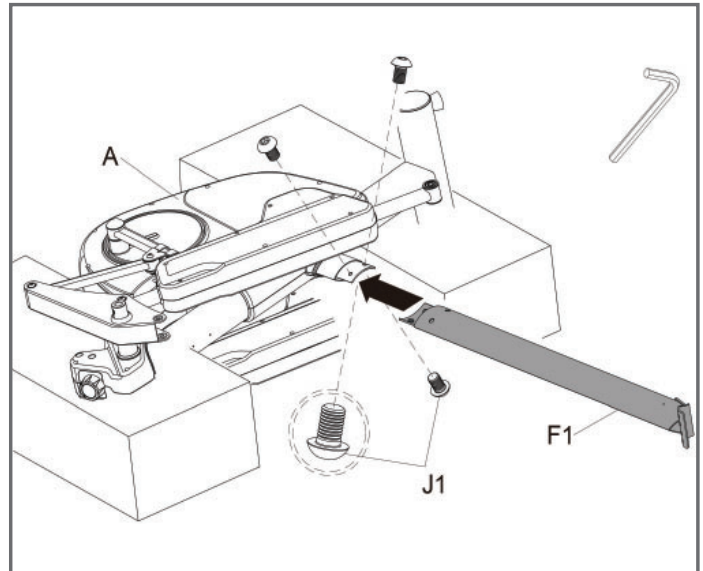

## Step 3: Assembly of the side bar cover sets (L+R)

1. Mount the right side bar cover (R1) with a screw (J2) on to the cover (R1).
2. Follow steps 2.1 to 2.4 in order to tighten the side bar cover sets.
  - 2.1. Connect the covers (R1 & R2) on the right connection bar (C2).
  - 2.2. Connect the cover (R3) to the bar (C2).
  - 2.3. Connect the cover (R4) to the bar (C2).
  - 2.4. Secure the covers with the screw (J3) first and then with two screws (J2) as illustrated.
3. Repeat the same steps as described before in order to assemble the left side bar cover set.

Tool: 4mm (Phillips screwdriver)

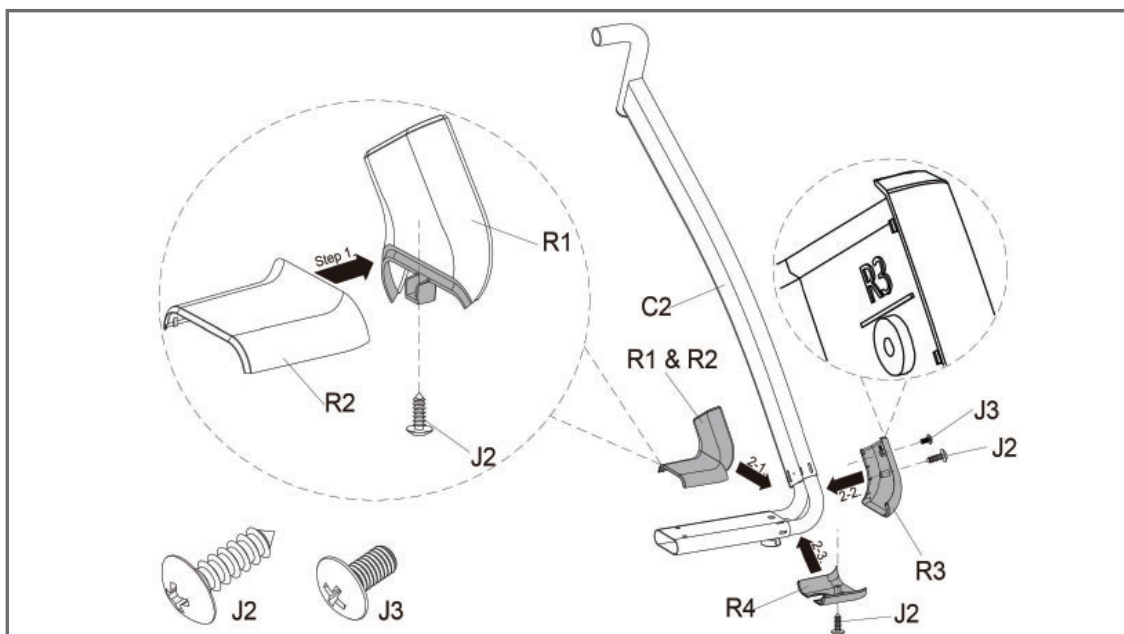



#### Step 4: Assembly of the right side bar (C2)

1. Mount the right side bar (C2) on the main frame (A) with a screw (J8) on top (figure A) and two screws (J5) including washers (J5) with the bracket (F2) on the bottom (figure B).

► **ATTENTION**

Do not tighten the screws (J6 and J4) completely yet.

2. Raise the main frame (A) with two people and remove the foam (see figure on the right).

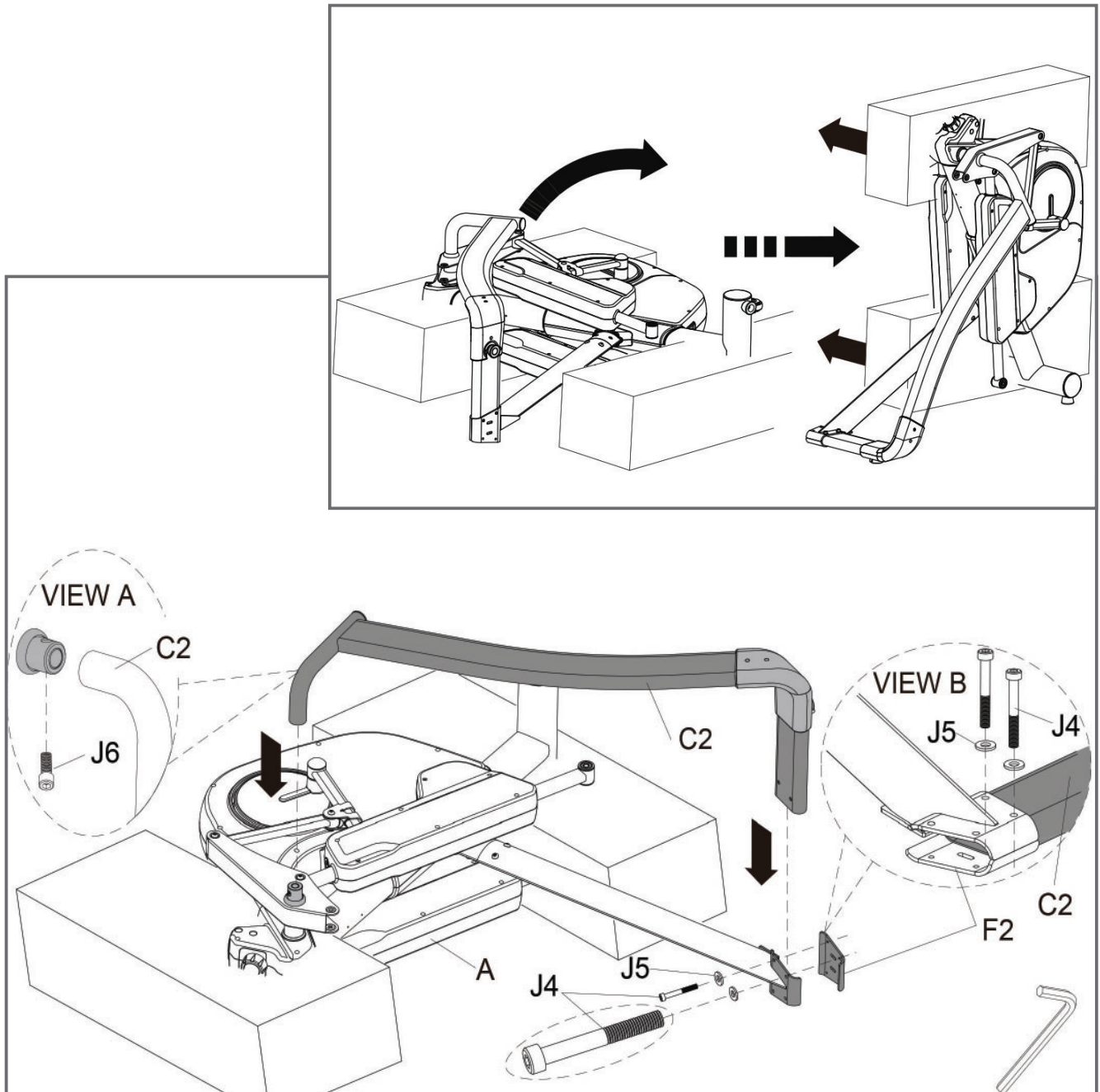



### Step 5: Assembly of the left side bar (C1) and covers

1. Connect the left side bar (C1) on the main frame (A) with a screw (J6) on top and two screws (J2) and the bracket (F2) on the bottom.
2. Tighten all of the screws from the previous steps.

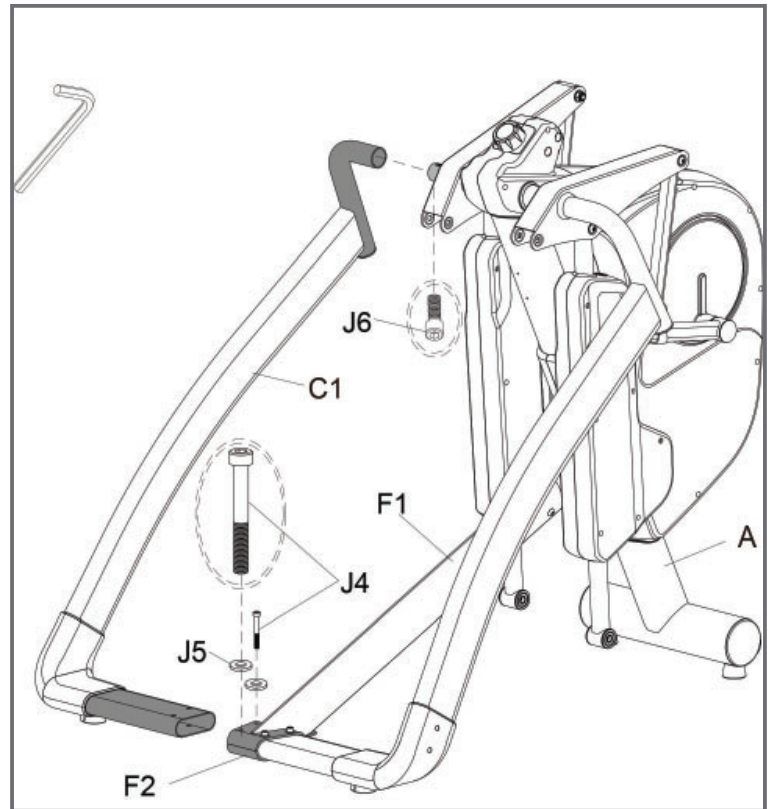

### Step 6: Assembly of the pedal bars

1. Connect the right pedal bar (B2) on the top with the main frame (A) and mount it with the nuts (J9), washers (J8) and screws (J3) as in figure C.
2. Mount the pedal bar on the bottom of the main frame with a bolt (J5), a washer (J8) and a nut (J9) as in figure D.
3. Tighten the bolts (J5) and the nuts (J9); see figure E.
4. Repeat the process for the left pedal bar (B1).

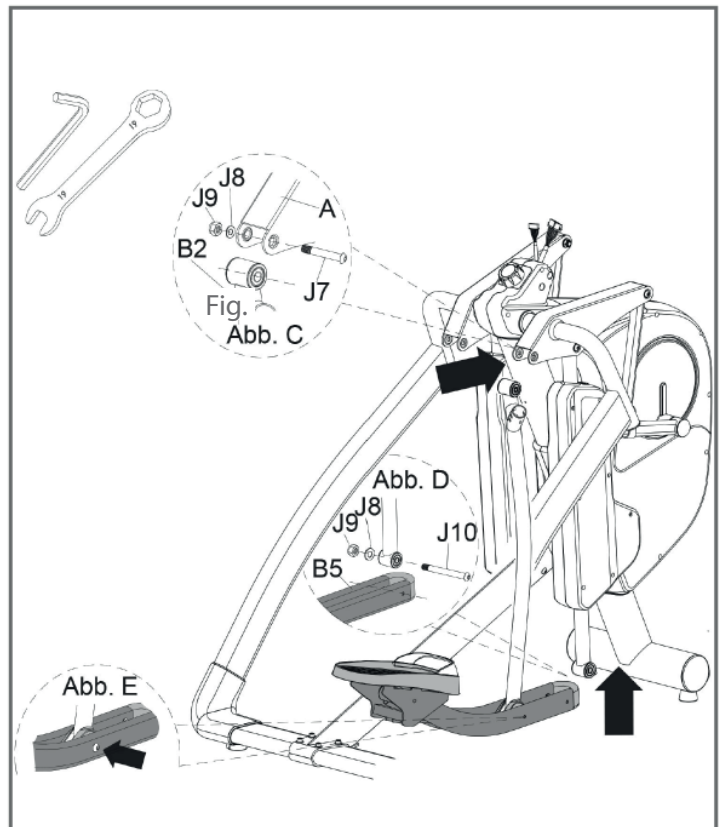

### Step 7: Assembly of the handles

1. Loosen the three pre-mounted screws (J12 and J11) from the left handle (E1).
2. Connect the left handle (E1) with the main frame (A) by tightening all screws (J12 and J11) with two 6mm Allen keys; see figure F.
3. Repeat the process for the right handle (E2).

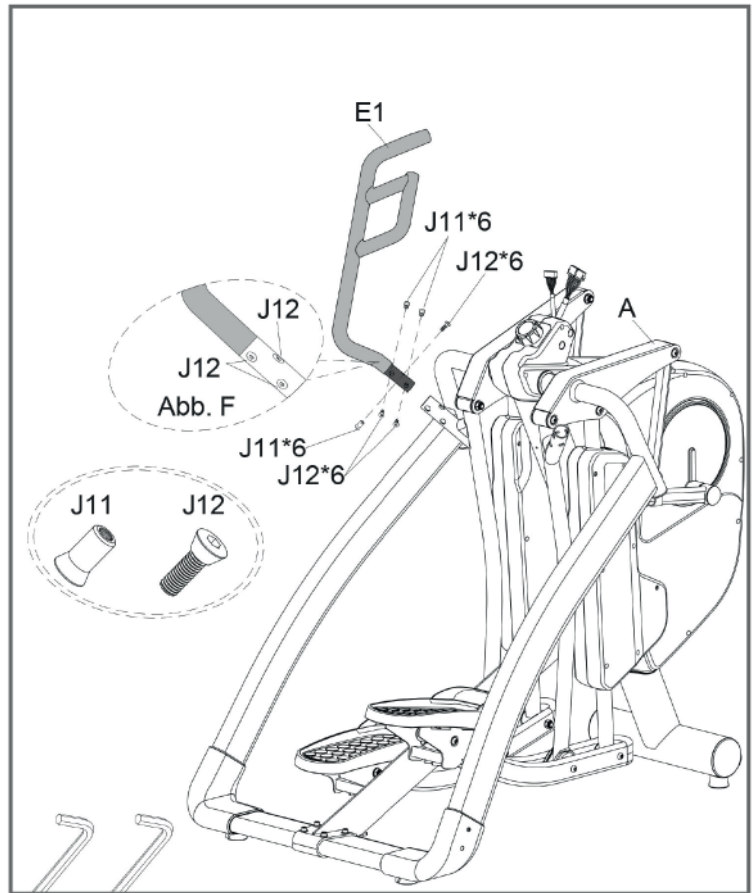

### Step 8: Assembly of the console mast and the bottle holder

1. Connect the cable (D1 and D2) from the console mast (D) with the cables (A1 and A2) from the main frame (A).
2. Mount the console mast (D) on the main frame (A) with two screws (J3) and two pre-mounted screws (J13); see figure G.
3. Mount the bottle holder (H) on the main frame (A) with two screws (J14).

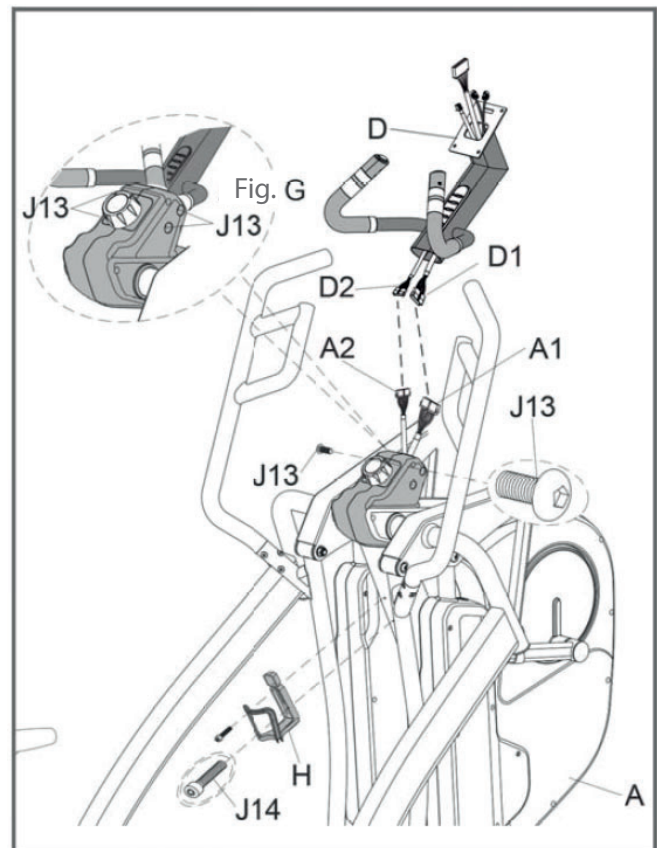

### Step 9: Assembly of the console and setting the supporting feet

1. Loosen the four pre-mounted screws (G1) from the console (G).
2. Connect the console cables (D1& D3) and the heart rate cable (D4) from the console mast with the console.

**NOTICE**

Make sure that the cables are properly connected with each other. Slide the excess cable into the casing and the console mast (D).

3. Mount the console (G) on the console mast (D) with the four screws (G1).
4. Use the adjusting screws under the side parts in order to level out any unevenness in the floor.

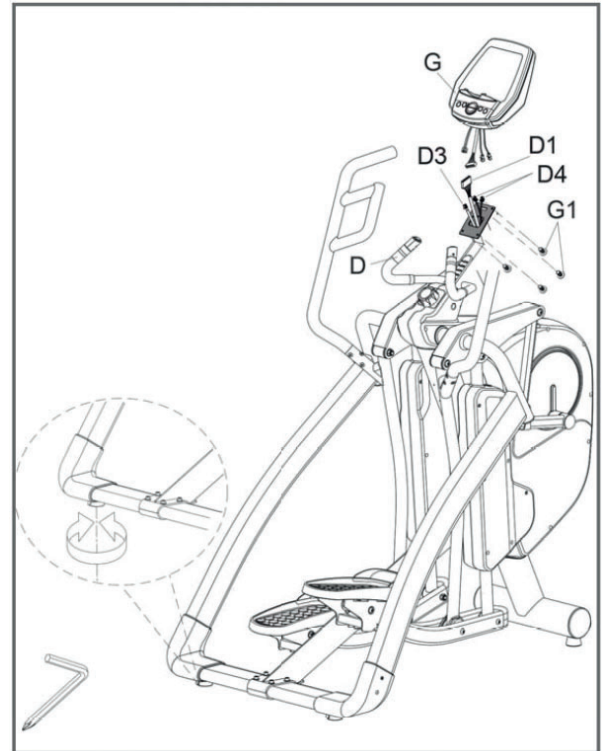

### Step 10: Locking the pedal bars (B1 and B2)

**CAUTION**

- + The pedal bars should always be locked if the equipment is not being used.
- + Never lock the pedal bars if the equipment is still moving, but rather only when the equipment has come to a complete standstill.

To do this, turn the knob (A3) to the "LOCK" position in order to lock the pedal bars (B1 and B2) and avoid possible injuries.

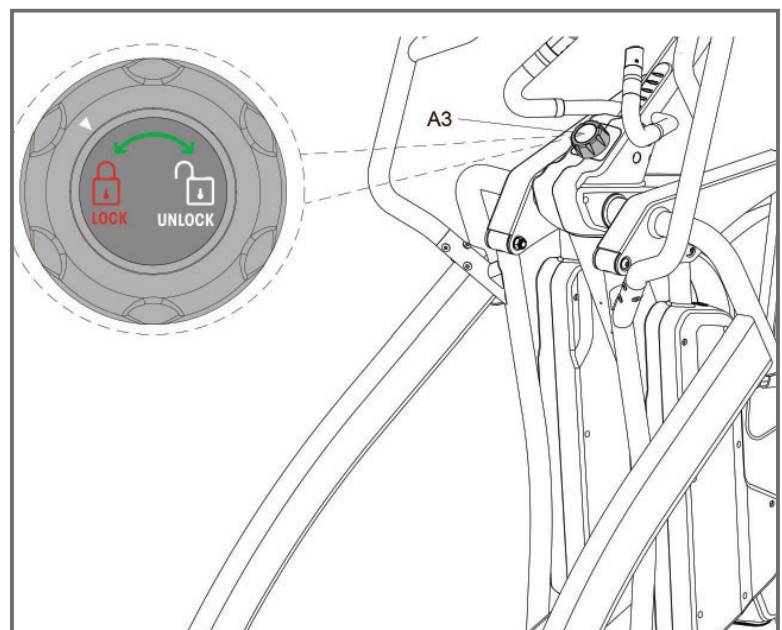

### Step 11: Function buttons to adjust the stride length:

1. There is a button on the left and right small handles of the console mast. The left button has the following function: The fine, infinitely variable reduction of the current stride length. The right button has the following function: The fine, infinitely variable increase of the current stride length.
2. If the stride length is reduced, the DOWN signal on the function button will light up in green. If the stride length is increased, the UP signal on the function button will light up in red.

**The button for adjustments will not react as long as the stride length is being changed through the button and the LED light is blinking. The button only works if the LED light is illuminated. If there are disruptions while training, simply press any stride length adjustment button and the training can be continued.**

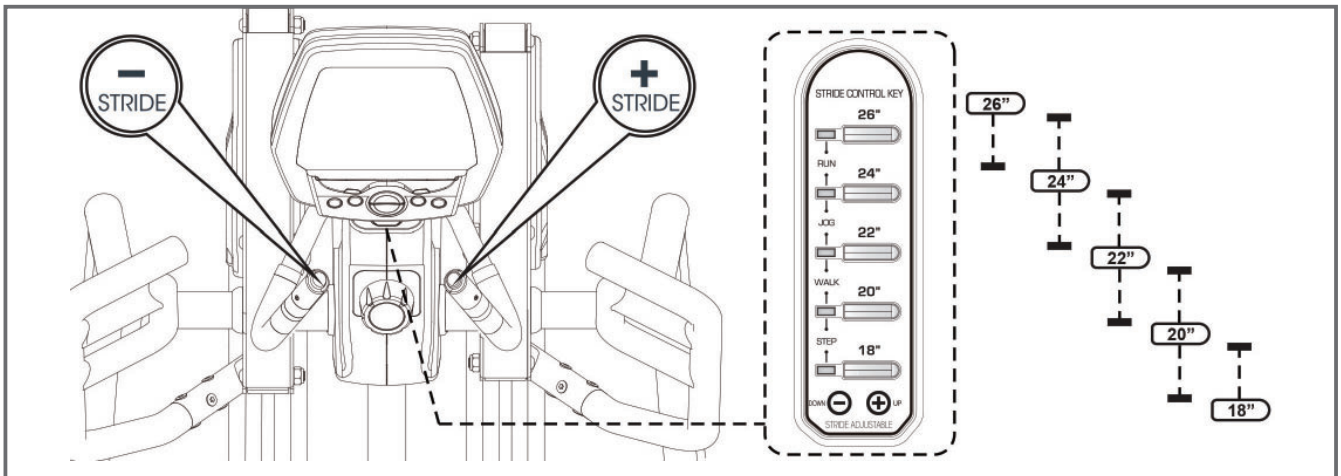



## Step 12: Setting the stride length via the incline motor

Corresponding to personal requirements, the stride length, as shown on the LED display, can be set or changed to 18", 20", 22", 24" or 26". There are five quick selection buttons to set the stride length. Press one of the 18" - 26" buttons to set the desired stride length. You can change the stride length at any time during training. The selected stride length is displayed through the blue LED light.

There are different reasons for a user wanting to change the stride length. First because of the height. A user who is smaller than 1.65m could feel more comfortable with a stride length of 18" (approx. 46 cm) to 22" (approx. 56 cm), while a user who is taller than 1.65 cm could feel more comfortable with a stride length of 22"(approx. 56 cm) to 26" (approx. 66 cm), because they can compensate for their stride length. Furthermore, a user must adjust the stride length with higher speeds in order to compensate for their normal stride length while jogging/running. Another reason why a user may want to change the stride length during training is so that different muscle groups can be worked; a short stride length is demanding for different muscles in the legs and body than a long stride length. A stride length of 18" (approx. 46 cm) can be compared with a shorter kick motion and a stride length of 26" (approx. 66 cm) with a lunge without high stress, which would cause the same movement on a flat surface.

During training, adjusting the resistance or doing squats while holding on to the handle bars helps to isolate these muscles.

### ① NOTICE

- + There is no right or wrong stride length for every usage. Select the stride length where you feel the most comfortable.
- + If the stride length motor is activated, you will hear how the motor unlocks and gets set. As soon as the motor has reached the desired stride length, you will hear a click and the motor will lock into the corresponding position.

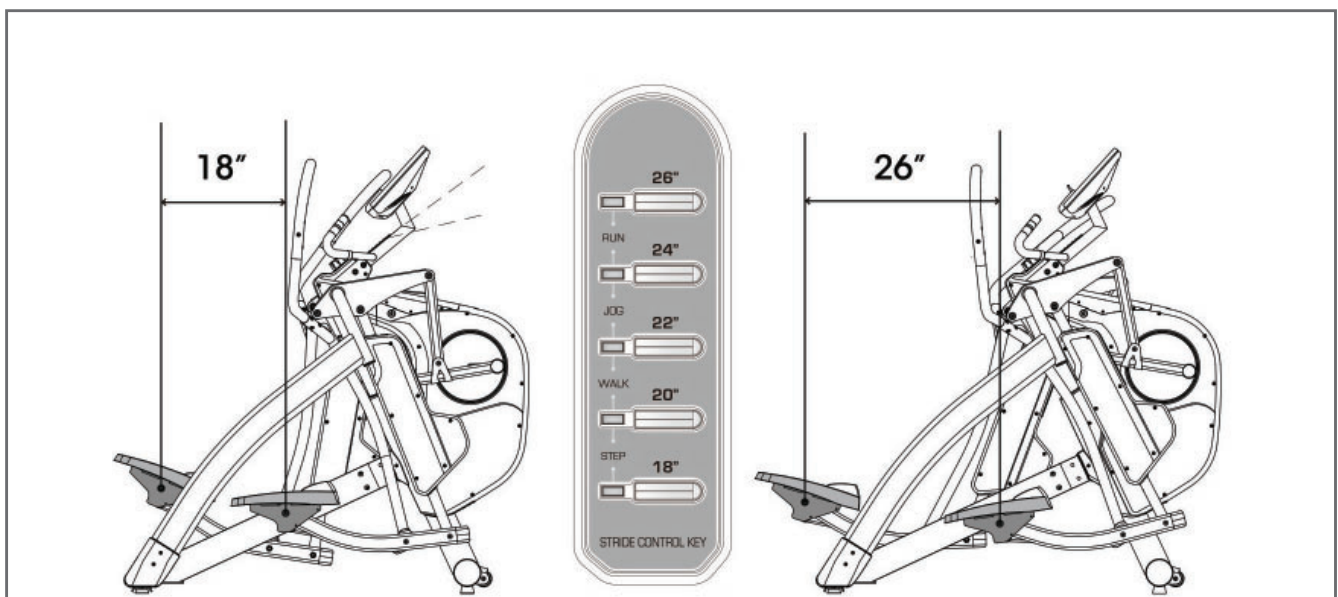

### Step 13: Alignment of the feet

If the floor is uneven, you can stabilize the equipment by turning the two setting screws under the main frame.

1. Lift the equipment on the desired side and rotate the setting screws under the main frame.
2. Rotate the screws clockwise in order to remove them and to raise the equipment.
3. Rotate them counterclockwise in order to lower the equipment.

### Step 14: Connecting the equipment to the mains supply

#### ► ATTENTION

The equipment must not be connected to a multiple socket, otherwise it cannot be guaranteed that the equipment will be supplied with sufficient power. Technical errors can result.

Plug the power plug into a wall outlet that complies with the instructions in the chapter on electrical safety.

\*\*The overload switch protects from short circuits. The button jumps out in case of overload. Turn the power switch off and then on again to restart the equipment

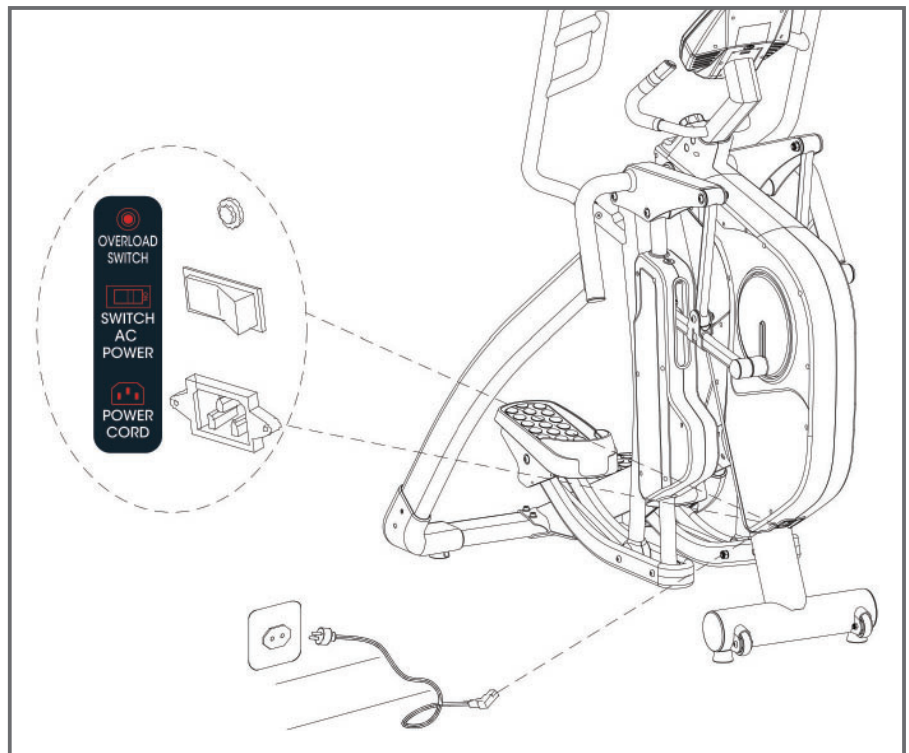

## 3 OPERATING INSTRUCTIONS

### ① NOTICE

Familiarise yourself with all the functions and setting options of the device before starting training. Have the proper use of this product explained to you by a specialist.

### 3.1 Console Display



<b>Time</b>	0:00 - 99:00 minutes
<b>Speed</b>	0.0 - 99.9 km/h
<b>RPM (cadence; rotations per minute)</b>	0 - 999 RPM
<b>Distance</b>	0.0 - 99.9 km
<b>Calories</b>	0 - 990 Cal
<b>Gender</b>	Male (m) / Female (w)
<b>Pulse (heart rate; heartbeats per minute)</b>	30 - 230 BPM
<b>Heart rate symbol</b>	On/off - blinking

<b>Programs</b>	P1 - P12
<b>User data</b>	U1 - U4
<b>Watt/load (output/resistance)</b>	0 - 999 Watt; Watt control: 10 - 350 Watt
<b>Level</b>	1 - 16
<b>H.R.C. (heart rate control)</b>	55 / 75 / 90% of the max. heart rate; manual target rate (TAG)
<b>Age</b>	1 - 99 years
<b>Height</b>	100 - 250 cm
<b>Weight</b>	20 - 150 kg (44 – 330 lbs)

### 3.1 Button Functions

<b>MODE</b>	Confirmation of all setting values.
<b>RESET</b>	Resetting all setting values. Press and hold for two seconds so that the motor returns to the turn-on mode.
<b>START/STOP</b>	Start or stop the training. Once the count-down has reached 0:00, the console will stop automatically and beep for eight seconds. The duration after this changes automatically to the previously set time. If the user ends the training, the console will display all setting values and will show a heart rate diagram.
<b>UP</b>	Increase the values.
<b>DOWN</b>	Decrease the values.
<b>RECOVERY</b>	In the stop or start mode; if the button is pressed, the measurement of the recovery pulse starts.
<b>P1 - P12</b>	Quick buttons for program profiles 1 - 12



## 3.2 Turning On and Setting the Equipment

### ① NOTICE

If the user stops pedaling for more than four minutes, the console will change into the energy saving mode. All settings and training data will be saved until the next training is started.

1. Connect the power cable and the console will turn on with a long beep and all segments from the LCD display will light up for two seconds. (image A).

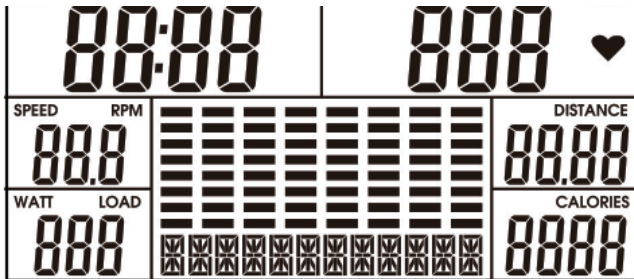

Image A



Image B

On the console the main menu (image B) appears.

In the main menu, the first training program *MANUAL* lights up.

2. press UP and DOWN to select a program.



## 3.3 Programs

### 3.3.1 Quick Start and Manual

Before training in the manual mode, the user can set the TIME, DISTANCE, CALORIES and PULSE target values. After turning on the equipment, the user can press START/STOP to train directly in the manual mode without any settings.

The level can be changed during training by pressing UP or DOWN.

### 3.3.2 PROG - Pre-set programs

In the stop mode, the user can press the P1-P12 buttons to get to the selected program quickly. Before training in the program mode, the user can set a target time (TIME). Press UP or DOWN in order to select a program profile and press ENTER/MODE to confirm. The level can be changed during training by pressing UP or DOWN.

#### Profiles from pre-set training programs:

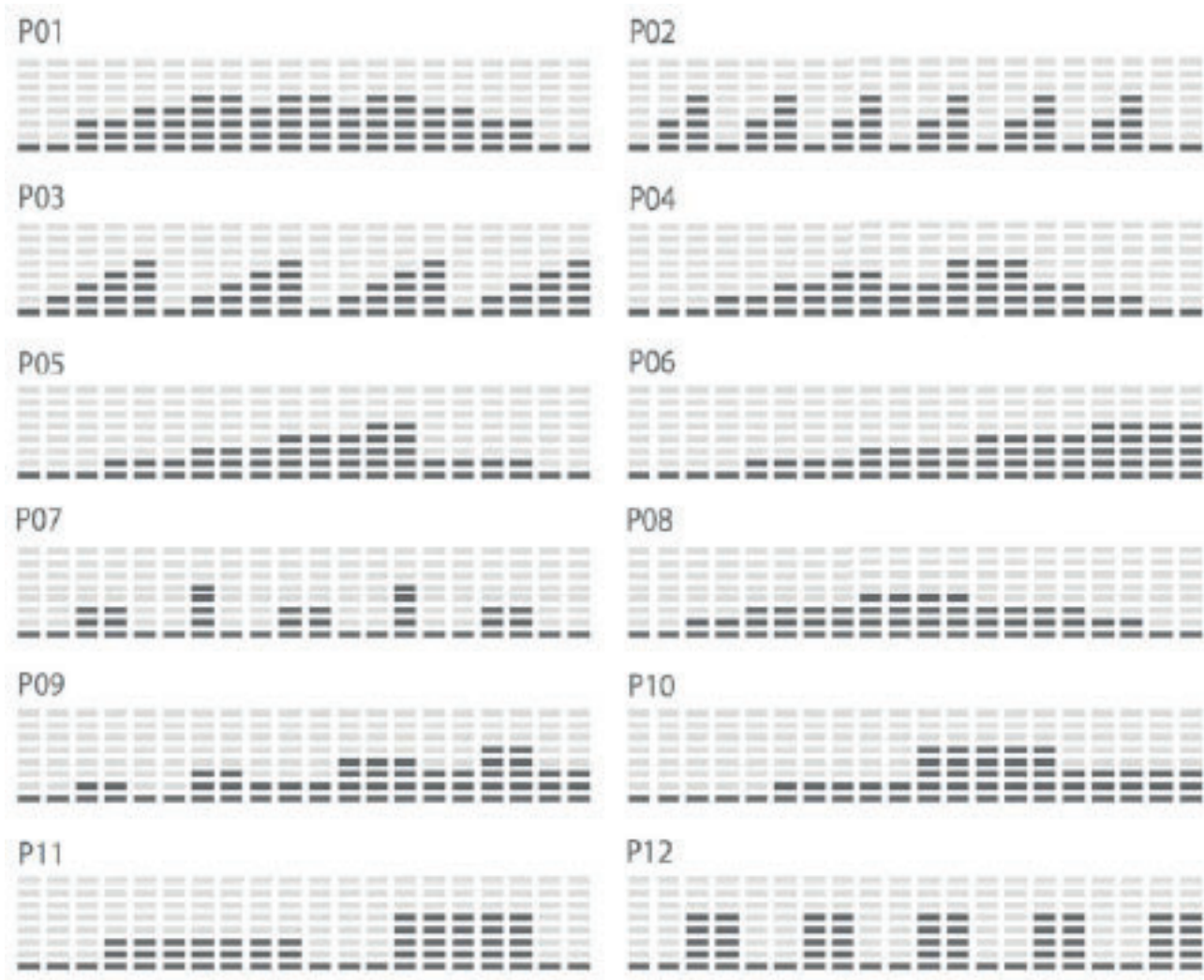

### 3.3.3 H.R.C. - Heart rate controlled programs

#### WARNING

Your training equipment is not a medical device. The heart rate measurement of this equipment may be inaccurate. Various factors can affect the accuracy of the heart rate measurement. The heart rate measurement serves only as a training aid.

Before heart rate controlled training, the user can select 55%, 75% or 90% of the target heart rate.

The computer automatically calculates the user's age and the target heart rate.

The user can set the training duration and press START/STOP in order to begin the training.

### 3.3.4 H.R.C. - Heart rate controlled programs

Before heart rate controlled training, the user can select 55%, 75% or 90% of the target heart rate.

The computer automatically calculates the user's age and the target heart rate.

The user can set the training duration and press START/STOP in order to begin the training.

### 3.3.5 USER - User defined program

The user can press UP, DOWN and then MODE to create their own profile. (from row 1 to row 2) Press and hold the MODE button for two seconds to end the profile setting.

### 3.3.6 WATT - Watt controlled program

The default Watt value is 120W; in order to change this value, the user can press UP/DOWN.

When beginning training, the console adjusts the resistance level corresponding to the training status of the user and their actual Watt value.

### 3.3.7 RECOVERY - Fitness test

Press and hold the RECOVERY button after you have trained for some time.

All display functions are ended except for the TIME function; this starts a countdown of 00:60 to 0:00.

Then your pulse/heart rate recovery status will appear on the display from F1, F2 to F6. F1 is the best status, F6 is the worst. The user can continue to train in order to improve the pulse/heart rate recovery status.

Press RECOVERY button again in order to return to the main menu.

Result	Fitness level
F1	Very good
F2	Good
F3	Average
F4	Sufficient
F5	Poor
F6	Very poor

## 4.1 General Instructions

### WARNING

- + The storage location should be chosen so that improper use by third parties or children can be prevented.
- + If your equipment does not have transportation wheels, the equipment must be disassembled before transportation.

### ▶ ATTENTION

- + Make sure that the equipment is protected from moisture, dust and dirt in the selected storage location. The storage location should be dry and well ventilated and have a constant ambient temperature between 5°C and 45°C.

## 4.2 Transportation Wheels

### ▶ ATTENTION

If you want to transport your equipment over particularly sensitive and soft floor coverings, such as parquet, planks or laminate, lay out the transport route with cardboard or similar to avoid possible floor damage.

1. Stand behind the equipment and lift it until the weight is transferred to the transportation wheels. After that, you easily can move the equipment to a new position. For long transport distances the equipment should be disassembled and safely packed.
2. Select the new location by following the instructions in the section 1.4 of this manual.

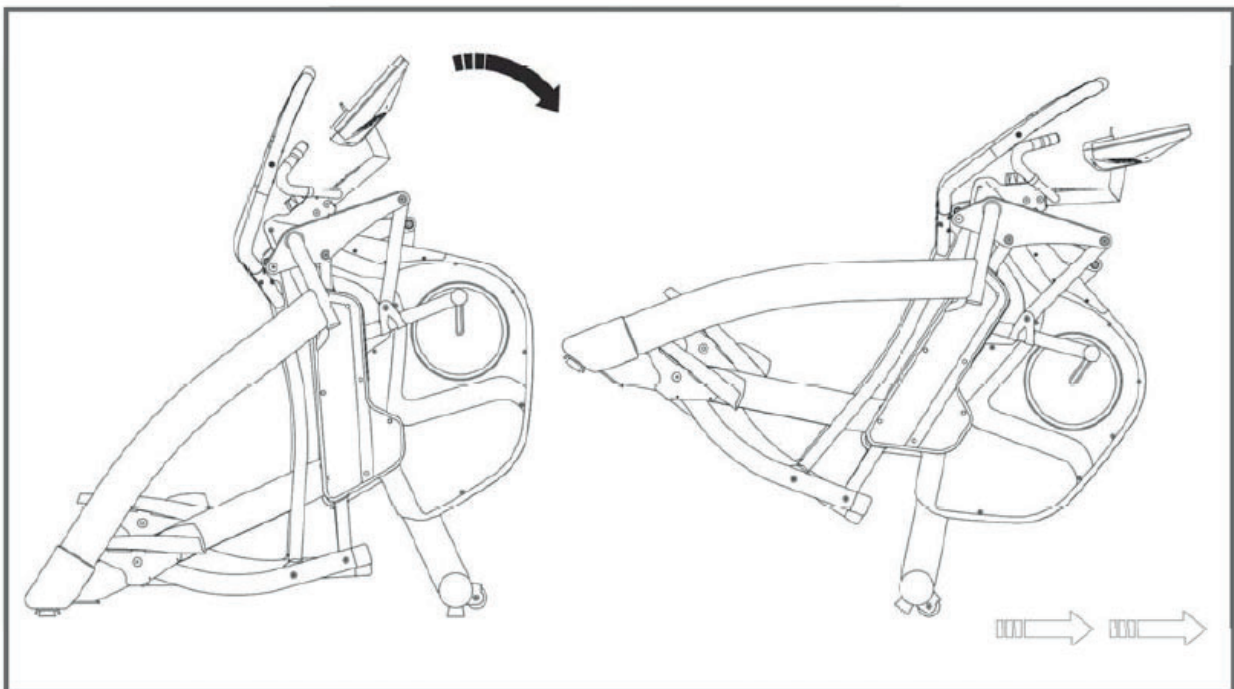

## 5.1 General Instructions



### WARNING

- + Do not make any improper changes to the equipment.



### CAUTION

- + Damaged or worn components may affect your safety and the life of the equipment. Therefore, immediately replace damaged or worn components. In such a case, contact the contract partner. The equipment must not be used until it has been repaired. If necessary, use only original spare parts.

### ATTENTION

- + In addition to the instructions and recommendations for maintenance and care given here, additional service and/or repair work may be necessary; this must only be carried out by authorised service technicians.

## 5.2 Faults and Fault Diagnosis

The equipment undergoes regular quality controls during production. Nevertheless, faults or malfunctions may occur. Frequently, individual parts are responsible for these disturbances, an exchange is usually sufficient. Please refer to the following overview for the most common errors and how to correct them. If the equipment still does not function properly, contact your contract partner.

Fault	Cause	Solution
Drive disks wobble/ make noises	Drive disk loose	Tighten nut (pay attention to left-hand / right-hand thread)
Display is blank/is not working	Loose cable connections	Check cable connections
Equipment wobbles	Equipment is not level	Align the feet
Creaking noises on the stepping area	Loose screws on stepping area	Tighten the screws on the stepping area
Creaking noises	Screw connections loosened or too tight	Check screw connections
Squeaking noises on the guide rails	Guide rails or rollers dirty or guide rails dry	Clean the guide rails and then lubricate them with a suitable lubricant
No pulse display	<ul style="list-style-type: none"> <li>+ Sources of interference in the room</li> <li>+ unsuitable chest strap</li> <li>+ Wrong position of chest strap</li> <li>+ Chest strap defective or battery empty</li> <li>+ Pulse display defective</li> </ul>	<ul style="list-style-type: none"> <li>+ Eliminate sources of interference (e.g. mobile phone, WLAN, lawn mower and vacuum cleaner robot, etc. ...)</li> <li>+ Use a suitable chest strap (see RECOMMENDED ACCESSORIES).</li> <li>+ Reposition chest strap and/or moisten electrodes</li> <li>+ Changing batteries</li> <li>+ Check if pulse display by hand pulse possible</li> </ul>

## 5.3 Maintenance and Inspection Calendar

To avoid damage from body sweat, the equipment must be cleaned with a damp towel (no solvents!) after each training session.

The following routine tasks must be performed at the specified intervals:

Part	Weekly	Monthly	Quarterly
Display console	C	I	
Slide rails			C
Lubrication of slide rails and moving parts			I
Plastic covers	C	I	
Screws and cable connections		I	
Legend: C = clean; I = inspect			

\*Make sure to always clean the slide rails and moving parts before re-lubricating.

By scanning the QR code with the camera function or QR code scanner app of your smartphone/tablet, a video on general maintenance of a crosstrainer opens on YouTube. The video serves to illustrate the maintenance points described in this manual.

Please note that the video may not be available in your language or with appropriate subtitles.

If you cannot scan QR codes, you can access all Sport-Tiedje videos on YouTube by first opening YouTube and entering "Sport-Tiedje" in the search field.



## 6 DISPOSAL

At the end of its operational life, this equipment cannot be disposed of in normal household waste. Instead, it must be disposed of via an electricals recycling centre. Further information can be obtained from your local authority's recycling service.



The materials can be recycled as per their symbols. Through the reuse, recycling of materials or other forms of recovery of old equipment, you make an important contribution to the protection of the environment.



## 7 RECOMMENDED ACCESSORIES

To make your training experience even more efficient and pleasant, we recommend that you add suiting accessories to your fitness equipment. For elliptical cross trainers this could for example be a **floor mat**, which makes your fitness equipment stand more securely and also protects the floor from sweat or **silicone spray** to keep moving parts in good shape.

If you have purchased a fitness machine with pulse training and want to train your heart rate, we strongly recommend that you use a compatible **chest strap**, as this ensures optimum transmission of the heart rate.

Our range of accessories offers the highest quality and makes training even better. If you would like to find out more about compatible accessories, please go to the detail page of the product in our webshop (the easiest way is to enter the article number in the search field above) and go to the recommended accessories on this page. Alternatively, you can use the QR code provided. Of course, you can also contact our customer service: by telephone, e-mail, in one of our branches or via our social media channels. We will be happy to advise you!



chest strap



floor mat



silicone spray



chest strap contact gel

## 8.1 Serial Number and Model Name

In order to provide you with the best possible service, please have the model name, article number, serial number, exploded drawing and parts list ready. The corresponding contact options can be found in chapter 10 of this operating manual.

**NOTICE**

The serial number of your equipment is unique. It's located on a white sticker. The exact position of this sticker is shown in the following illustration.



Enter the serial number in the appropriate field.

**Serial number:**

**Brand / Category:**

**Model Name:**

**Article Number:**



## 8.2 Parts List

No.	Name	Qty.	No.	Specification	Qty.
A	MAIN FRAME	1	A49	AXLE $\Phi$ 25x160mm	1
A1	SENSOR WIRE 900mm	1	A50	MAGNETIC $\Phi$ 15x7	1
A2	CONTROLLER WIRE 500mm	1	A51	BELT WHEEL $\Phi$ 360 (J10)	1
A3	KONB	1	A52	BELT 530 (1355mm)Xj8	1
A4	CONNECTION SLICE 40 (4T)	4	A53	NUT M8	14
A5	INCLINE MOTOR SENSOR WIRE	2	A54	OSCILLATING AXLE BASE ( R )	1
A8	INCLINE MOTOR CONTROL BOX	1	A55	OSCILLATING AXLE BASE ( L )	1
A9	SCREW M5x10	2	A56	HANDLEBAR SUPPORTING COVER	2
A10	ADAPTOR	1	A57	BEARING 6905 (TPX)	2
A11	DC WIRE600mm	1	A58	END CAP $\Phi$ 4"	2
A12	SOCKET	2	A59	FIX CUSHION $\Phi$ 50TPR	2
A13	NUT	1	A60	WASHER M6x2Tx $\Phi$ 19	2
A14	SCREW M3x8	4	A61	SCREW3/16"x5/8	2
A15	SENSOR WIRE 100mm	1	A62	FRONT CONNECTING SHAFT	2
A15-1	SENSOR WIRE HOUSING	1	A63	END CAP	1
A15-2	SENSOR WIRE HOUSING SCREW	1	A64	BUSH $\Phi$ 12.1x $\Phi$ 16x20mm	4
A16	MOTOR	12	A65	CLIP (36)	8
A17	WIRE (OVERLOAD SWITCH TO AC POWER SWITCH)	1	A66	BEARING 6004 (TPX)	2
A18	BEARING 6005zz (TPX)	2	A67	BEARING SLEEVE $\Phi$ 42x3T	8
A19	BRAKE DEVICE (3T)	1	A68	SCREW M8x45	2
A20	SCREW M6x43	1	A69	NUT M4	10
A21	SCREW M8x16	1	A71	CRANK CONNECTING SHAFT	2
A22	WASHER M10	2	A72	BEARING 2203 (MRB)	2
A23	OVERLOAD SWITCH	1	A73	NUT M10	2
A24	WIRE (OVERLOAD SWITCH TO AC POWER SWITCH)	1	A74	CLIP (R40)	2
A25	POWER CONNECTION WIRE	1	A75	BUSH $\Phi$ 12.1x $\Phi$ 16x10.5mm	4
A26	SWITCH AC POWER	1	A76	SCREW M4x38mm	4

A27	POWER CORD SOCKET	1	A77	FLAT KEY 7x7x20mm	2
A28	SCREW M3x10	2	A80	FRONT PEDAL SUPPORTING TUBE	2
A29	SCREW M8x10	2	A81	WASHER M10xΦ27x2T	2
A30	TRANSPORTATION WHEEL	2	A82	SCREW M10x40mm	2
A31	SCREW M12x53	4	A83	NUT	4
A32	PRESSING PIPE	1	A84	BRAKE	1
A33	WASHER Φ10xΦ23x2T	2	A85	SPRING	1
A34	BEARING 6200 (MRB)	2	A87	AXLE FOR MOTOR PUSH ROD	2
A35	SCREW M10x30	1	A88	NUT	2
A36	JSHAPE SCREW M6	1	A89	NYLON SLEEVE	8
A37	WIRE (AC POWER SWITCH TO POWER CORD)	1	A90	PUSH ROD BRACKET (FRONT)	2
A38	WASHER M6x Φ16xΦ29.2x2T	1	A91	END CAP	1
A39	GROUND WIRE	1	A93	PUSH ROD BRACKET (REAR)	2
A40	POWER CORD	1	A94	SCREW M8x20	8
A41	FLYWHEEL Φ327	1	A95	SCREW 5/32"x3/4" (M4x19mm)	12
A42	NUT3/8"	2	A96	NUT M6	2
A43	TENSION CABLE 400mm	1	A97	SIDE DECORATION HOUSING SET ( L )	2
A44	SCREW M5x10	4	A98	SIDE DECORATION HOUSING SET ( R )	2
A45	TURING PLATE	2	A99	FRONTSIDE DECORATION COVER	2
A46	CRANK	2	A100	SCREW M4x20	10
A47	BEARING NUT	1	A101	END CAP	4
A47-1	BUSH Φ25.2xΦ29.2x54.5mm	1	A102	SMALL CHAIN COVER ( L )	1
A47-2	BUSH Φ25.2xΦ29.2x5mm	1	A103	MAIN CHAIN COVER ( L )	1
A48	SCREW M8x25	4	A104	UPPER DECORATION HOUSING	1
A105	SMALL CHAIN COVER ( R )	1	D3	SENSOR WIRE 300mm	1
A106	MAIN CHAIN COVER ( R )	1	D4	HANDLE PULSE WIRE	2
A107	SCREW M4x12	8	D5	HANDLE PULSE RING Φ31.8x0.9Tx19.5mm	2

A108	MOTOR SENSOR WIRE HOUSING	2	D6	SPACER RING $\Phi 32 \times 30.4$	2
A109	MOTOR SENSOR WIRE HOUSING SCREW	2	D7	HANDLE PULSE	4
A110	END CAP	2	D8	UPPER HANDLE PULSE HOUSING	2
A111	CRANK HOUSING	2	D9	LOWER HANDLE PULSE HOUSING	2
A112	SCREW	2	D10	HANDLE PULSE RING $\Phi 31.8 \times 0.9 \times 30.5 \text{mm}$	2
A113	SIDE DECORATION HOUSING SCREW	4	D11	PLASTIC PIPE	2
B1	PEDAL SUPPORTING TUBE ( L )	1	D12	FOAM SPACER RING $\Phi 32 \times \Phi 25.8 \times 10 \text{mm}$	2
B2	PEDAL SUPPORTING TUBE ( R )	1	D13	SPONG HDR $\Phi 23 \times 3 \times 150 \text{mm}$	2
B3	BEARING SLEEVE	4	D14	SENSOR WIRE	1
B4	BEARING 6201 (TPX)	8	D15	SCREW M3x8	4
B5	LOWER PEDAL SUPPORTING TUBE	2	D16	SENSOR WIRE	1
B7	PEDAL BRACKET ( L )	1	D17	TOGGLE COVER L1	1
B8	PEDAL BRACKET ( R )	1	D18	TOGGLE COVER L2	1
B9	PEDAL REST ( L )	1	D19	PC BOARD LOAD -	1
B10	PEDAL REST ( R )	1	D20	TOGGLE LOAD -	1
B11	FRONT COVER PEDAL ( L )	1	D21	TOGGLE COVER R1	1
B12	CUSHION PAD ( L )	1	D22	TOGGLE COVER R2	1
B13	PEDAL ( L )	1	D23	PC BOARD LOAD +	1
B14	SCREW 5/32"x5/8" (M4x15mm)	6	D24	TOGGLE LOAD +	1
B15	SCREW M6x10mm	8	D25	SCREW	4
B16	PEDAL ( R )	1	D26	SENSOR WIRE	1
B17	CUSHION PAD ( R )	1	D27	SENSOR WIRE	1
B18	FRONT COVER PEDAL ( R )	1	E1	HANDLE BAR ( L )	1
B19	UPPER CAP FOR PEDAL SUPPORTING 20x60	2	E2	HANDLE BAR ( R )	1
B20	LOWER CAP FOR PEDAL SUPPORTING 20x60	2	F1	CENTRAL SUPPORTING TUBE	1
B21	SCREW 5/32"x1/2"	8	F2	IRON BRACKET	1

B22	MIDDLE PEDAL SUPPORTING ROD	2	G	CONSOLE	1
B23	NUT M8	4	G1	CONSOLE SCREW M5x10	4
B24	BUSH $\Phi 8 \times (\Phi 12 + \Phi 15)$	1	G2	STRIDE LED SENSOR BOARD	1
B25	BEARING 6001 (TPX)	4	H	WATER BOTTLE HOLDER	1
B27	SCREW M8x45	4	J1	SCREW M10x16	4
B30	SCREW M12x133	2	J2	SCREW M4x16	6
B31	BUSH $\Phi 15 \times \Phi 12.35 \times 90 \text{mm}$	2	J3	SCREW M4x6	2
B32	BEARING 6003zz	16	J4	SCREW M8x55	4
B33	BUSH	2	J5	WASHER M8x18	4
B34	PEDAL HOUSING ( R )	2	J6	SCREW M8x20	2
B35	PEDAL HOUSING ( L )	2	J7	SCREW M12x73	6
B36	SCREW	4	J8	WASHER M12x20	18
B37	PEDAL REINFORCEMENT STRIP	4	J9	NUT M12	18
B38	SCREW	8	J10	SCREW M12x109	4
C1	SIDE CONNECTING TUBE ( L )	1	J11	HANDLE BAR SCREW	6
C2	SIDE CONNECTING TUBE ( R )	1	J12	HANDLE BAR SCREW	6
C3	END CAP	2	J13	SCREW M8x16	4
C4	ADJUSTED NUT	2	J14	WATER BOTTLE HOLDER SCREW	2
C5	ADJUSTED END $\Phi 50$	2	L1	SIDE TUBE COVER SET (L1)	1
D	CONSOLE SUPPORTING TUBE	1	L2	SIDE TUBE COVER SET (L2)	1
D1	SENSOR WIRE 350mm	1	L3	SIDE TUBE COVER SET (L3)	1
D2	SENSOR WIRE 200mm	1	L4	SIDE TUBE COVER SET (L4)	1
R1	SIDE TUBE COVER SET (R1)	1	M4	SCREW	2
R2	SIDE TUBE COVER SET (R2)	1	N1	BUSH $\Phi 12.05 \times 17 \times 21.2 \text{mm}$	4
R3	SIDE TUBE COVER SET (R3)	1	N2	CLIP (R40)	2
R4	SIDE TUBE COVER SET (R4)	1	N3	BEARING 2203(MRB)	2
M1	BUSH	6	N4	SPACER RING (L)	4
M2	CLIP R32	8	N5	SPACER RING (R)	4
M3	MOTOR	2	N6	SCREW	8

# 8.3 Exploded Drawing

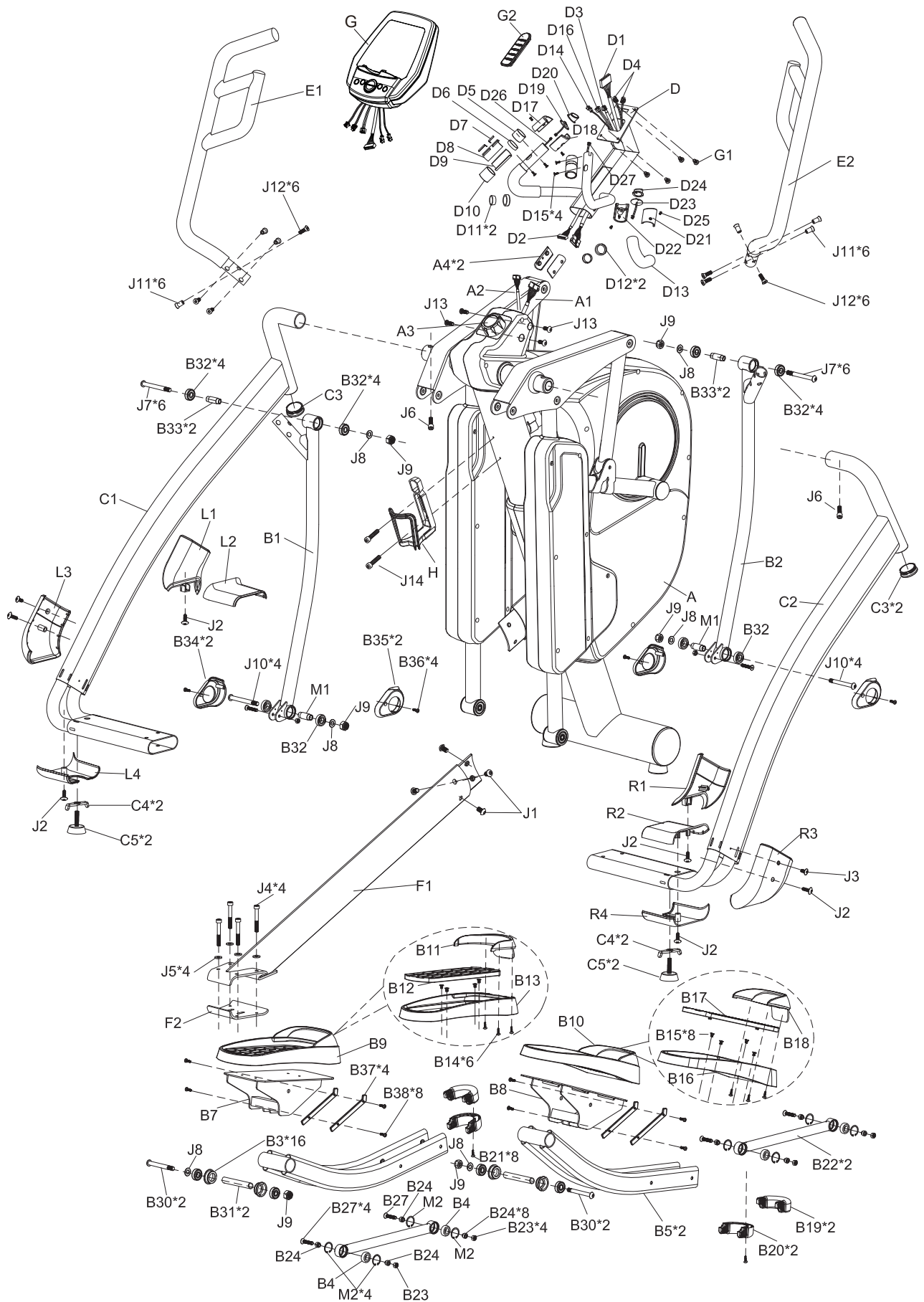

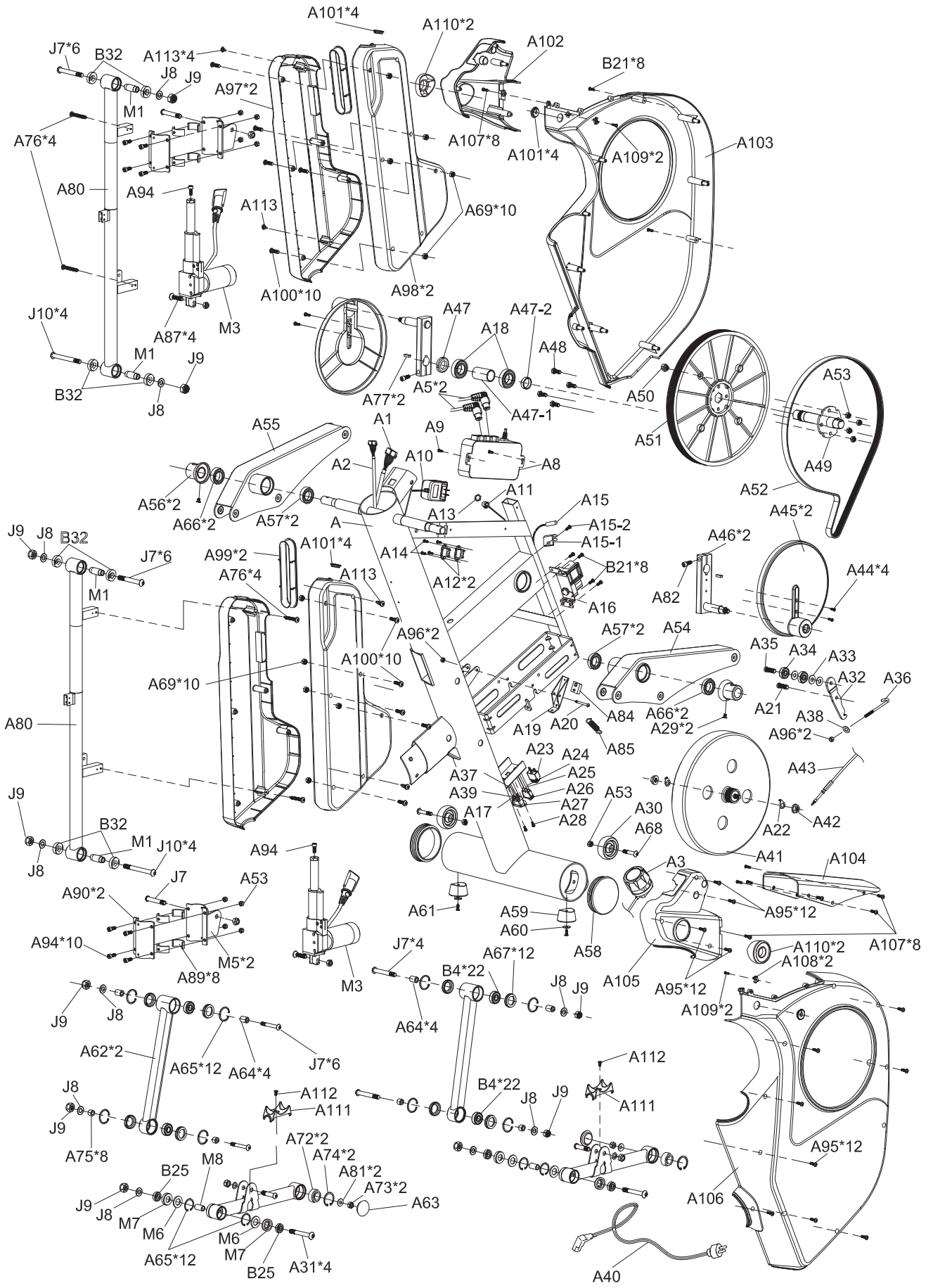

Training equipment from Taurus® is subject to strict quality control. However, if a fitness equipment purchased from us does not work perfectly, we take it very seriously and ask you to contact our customer service as indicated. We are happy to help you by phone via our service hotline.

### **Error Descriptions**

Your fitness equipment is developed for long-term, high-quality training. However, should a problem arise, please first read the operating instructions. For further assistance, please contact your contract partner or call our service hotline. To ensure your problem is solved as quickly as possible, please describe the defect as exactly as possible.

In addition to the statutory warranty, we provide a warranty for every fitness equipment purchased from us according to the following provisions.

### **Your statutory rights are not affected.**

### **Warranty**

The warranty is the first/original buyer and/or any person who received a newly purchased product as a gift from the original buyer.

#### **Warranty period**

The warranty periods, shown on our web shop, begin on delivery of the fitness equipment. The respective warranty periods for your equipment can be found on its product website.

### **Repair Costs**

According to our choice, there will either be a repair, a replacement of individual damaged parts or a complete replacement. Spare parts, that have to be mounted while assembling the equipment, have to be replaced by the warranty holder personally and are not a part of repair. After the expiration of the warranty period, the responsibility for parts costs, repair costs, installation costs and delivery costs lies with the warranty holder.

### **The terms of use are defined as follows:**

- + Home use: solely for private use in private households up to 3 hours per day
- + Semi-professional use: up to 6 hours per day (e. g. rehabilitation centres, hotels, clubs, company gyms)
- + Professional use: more than 6 hours per day (e. g. commercial gyms)

### **Warranty Service**

Within the warranty period, equipment which develops faults as a result of material or manufacturing defects, will be repaired or replaced at our discretion. Ownership of equipment or parts of equipment which have been replaced is transferred to us. The warranty period is not extended nor does a new warranty period begin following repair or replacement under the warranty.



## Warranty Conditions

For the warranty to be valid, the following steps must be taken:

Please contact our customer service by email or phone. If the product under warranty has to be sent in for repair, the seller bears costs. After expiry of the warranty, the buyer bears the costs of transport and insurance. If the fault is covered by our warranty, you will receive a new or repaired equipment in return.

### Warranty claims are invalid in case of damage resulting from:

- + misuse or improper handling
- + environmental influences (moisture, heat, electrical surge, dust, etc.)
- + failure to follow the current safety measures for the equipment
- + failure to follow the operating instructions
- + use of force (e. g. hitting, kicking, falling)
- + interventions which were not carried out by one of our authorized service centres
- + unauthorised repair attempts

### Proof of Purchase and Serial Number

Please make sure that you are able to provide the appropriate receipt when claiming on your warranty. So that we can clearly identify the model of your equipment, and for the purposes of our quality control, you will need to give the serial number of your equipment, when contacting the service team. Where possible please have your serial number and your customer number ready when you call our service hotline. It will help us to deal with your request swiftly.

If you cannot find the serial number on your fitness equipment, our service team is at your disposal to offer further information.







































### Service outside of the Warranty Period

We are also happy to issue an individual cost estimate if there is a problem with your fitness equipment after the warranty has expired, or in cases which do not fall under the terms of the warranty, e. g. normal wear and tear. Please contact our customer service team to find a quick and cost-effective solution to your problem. In such a case you will be responsible for the delivery costs.

### Communication

Many problems can be solved just by speaking to us as your specialist supplier. We know how important it is to you as a user of the fitness equipment to have problems solved quickly and simply, so you can enjoy working out with minimal interruption. For that reason, we also want to resolve your queries quickly and in a straightforward manner. Thus, please always keep your customer number and the serial number of the faulty equipment handy.



DE	DK	FR
<p><b>TECHNIK</b></p> <p> +49 4621 4210-900</p> <p> +49 4621 4210-698</p> <p> technik@sport-tiedje.de</p> <p> Öffnungszeiten entnehmen Sie unserer Homepage.</p>	<p><b>TEKNIK OG SERVICE</b></p> <p> 80 90 16 50</p> <p>+49 4621 4210-945</p> <p> info@fitshop.dk</p> <p> Åbningstider kan findes på hjemmesiden.</p>	<p><b>TECHNIQUE &amp; SERVICE</b></p> <p> +33 (0) 189 530984</p> <p>+49 4621 42 10 933</p> <p> info@fitshop.fr</p> <p> Vous trouverez les heures d'ouverture sur notre site Internet.</p>
<p><b>SERVICE</b></p> <p> 0800 20 20277 (kostenlos)</p> <p> 04621 4210 - 0</p> <p> info@sport-tiedje.de</p> <p> Öffnungszeiten entnehmen Sie unserer Homepage.</p>	<p><b>PL</b></p> <p><b>DZIAŁ TECHNICZNY I SERWIS</b></p> <p> 22 307 43 21</p> <p>+49 4621 42 10-948</p> <p> info@fitshop.pl</p> <p> Godziny otwarcia można znaleźć na stronie głównej.</p>	<p><b>BE</b></p> <p><b>TECHNIQUE &amp; SERVICE</b></p> <p> 02 732 46 77</p> <p>+49 4621 4210 933</p> <p> info@fitshop.be</p> <p> Vous trouverez les heures d'ouverture sur notre site Internet.</p>
UK	NL	INT
<p><b>CUSTOMER SUPPORT</b></p> <p> 00800 2020 2772</p> <p>+494621 4210 944</p> <p> info@sport-tiedje.co.uk</p> <p> You can find the opening hours on our homepage.</p>	<p><b>TECHNISCHE DIENST &amp; SERVICE</b></p> <p> +31 172 619961</p> <p> service@fitshop.nl</p> <p> De openingstijden vindt u op onze homepage.</p>	<p><b>TECHNICAL SUPPORT &amp; SERVICE</b></p> <p> +49 4621 4210-944</p> <p> service-int@sport-tiedje.de</p> <p> You can find the opening hours on our homepage.</p>
ES	AT	CH
<p><b>TECNOLOGÍA Y SERVICIOS</b></p> <p> 911 238 029</p> <p> info@fitshop.es</p> <p> Consulta nuestro horario de apertura en la página web</p>	<p><b>TECHNIK &amp; SERVICE</b></p> <p> 0800 20 20277 (Freecall)</p> <p>+49 4621 42 10-0</p> <p> info@sport-tiedje.at</p> <p> Öffnungszeiten entnehmen Sie unserer Homepage.</p>	<p><b>TECHNIK &amp; SERVICE</b></p> <p> 0800 202 027</p> <p>+49 4621 42 10-0</p> <p> info@fitshop.ch</p> <p> Öffnungszeiten entnehmen Sie unserer Homepage.</p>

Please find a detailed overview including address and opening hours for all stores of the Sport-Tiedje Group in Germany and abroad on the following website:

[www.sport-tiedje.com/en/stores](http://www.sport-tiedje.com/en/stores)

# WE LIVE FITNESS

## WEBSHOP AND SOCIAL MEDIA

Sport-Tiedje is Europe's largest specialist store for home fitness equipment with currently over 70 stores and one of the world's most renowned online mail order companies for fitness equipment. Private customers order via the 25 web shops in the respective national language or have their desired equipment assembled on site. In addition, the company supplies fitness studios, hotels, sports clubs, companies and physio practices with professional equipment for endurance and strength training.

Sport-Tiedje offers a wide range of fitness equipment from renowned manufacturers, high-quality in-house developments and comprehensive services, such as a build-up service and sports scientific advice before and after the purchase. The company employs numerous sports scientists, fitness trainers and competitive athletes.

Visit us also on our social media platforms or our blog!

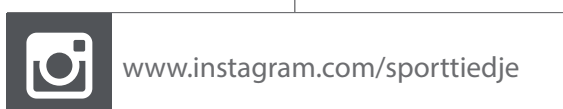

**TAURUS**

 cardiostrong

*BODYCRAFT*

 cardiojump

 **DUKEFITNESS**

**DARWIN**





Elliptical cross trainer **EX90 Plus**