



Assembly and Operating Instructions



max. 120 kg



~ 90 Min.



47 kg

L 145 | W 52 | H 160

CSTFX30.02.02

Art. No. CST-FX30-2

Elliptical Trainer **FX30**

Content

1	GENERAL INFORMATION	7
1.1	Technical Data	7
1.2	Personal Safety	8
1.3	Electrical Safety	9
1.4	Set-Up Place	10
2	ASSEMBLY	10
2.1	General Instructions	10
2.2	Scope of Delivery	11
2.3	Assembly	13
3	OPERATING INSTRUCTIONS	16
3.1	Console Display	16
3.2	Button Functions	17
3.3	Switch On	18
3.4	Programmes	18
3.4.1	Manual Programme (MANUAL)	18
3.4.2	Pre-Set Programmes (BEGINNER, ADVANCE, SPORTY)	19
3.4.3	Heart Rate Controlled Programmes (CARDIO)	20
3.4.4	Watt-controlled Programme (WATT)	21
3.5	Recovery Heart Rate Test	21
3.6	Body Fat Test	22
4	STORAGE AND TRANSPORT	23
4.1	General Instructions	23
4.2	Transportation Wheels	23
5	TROUBLESHOOTING, CARE AND MAINTENANCE	24
5.1	General Instructions	24
5.2	Faults and Fault Diagnosis	24
5.3	Error Codes and Troubleshooting	25
5.4	Maintenance and Inspection Calendar	26
6	DISPOSAL	26
7	RECOMMENDED ACCESSORIES	27

8	ORDERING SPARE PARTS	28
8.1	Serial Number and Model Name	28
8.2	Parts List	29
8.3	Exploded Drawing	31
9	WARRANTY	32
10	CONTACT	34

Dear customer,

Thank you for choosing fitness equipment from cardiostrong®. cardiostrong offers high-quality home fitness equipment that is optimally adapted to the conditions at home. Train at home no matter what the weather or time of the day. cardiostrong fitness equipment offers training programmes and a variety of equipment for all training levels and all training goals. Further information can be found at www.sport-tiedje.com or www.cardiostrong.de. We hope you enjoy your training!

Intended Use

The equipment may only be used for its intended purpose.

The equipment is only suitable for home use. The equipment is not suitable for semi-professional (e.g. hospitals, associations, hotels, schools, etc.) and commercial or professional use (e.g. fitness studios).

Legal Notice

Sport-Tiedje GmbH
Europe's No. 1 for home fitness

International Headquarters
Flensburger Straße 55
24837 Schleswig
Germany

Management:
Christian Grau
Sebastian Campmann
Dr. Bernhard Schenkel
No. HRB 1000 SL
Local Court Flensburg
European VAT Number: DE813211547

Disclaimer



©2010 cardiostrong® is a registered brand of the company SportTiedje GmbH. All rights reserved. Any use of this trademark without the explicit written permission of Sport-Tiedje is prohibited.

Product and manual are subject to change. Technical data can be changed without advance notice.

ABOUT THIS MANUAL

Please carefully read the entire manual before installation and first use. The manual will help you to quickly set up the system and explains how to safely use it. Make sure that all persons exercising with the equipment (especially children and persons with physical, sensory, mental or motor disabilities) are informed about this manual and its contents in advance. In case of doubt, responsible persons must supervise the use of the equipment.



This equipment has been manufactured according to the latest safety knowledge. As far as possible, potential safety hazards which could cause injury have been eliminated. Make sure to carefully follow the instructions and that all parts are securely in place. If required, read through the instructions again to correct any mistakes.

Please pay close attention to the safety and maintenance instructions given here. The contract partner cannot be held liable for damage to health, accidents or damage to the equipment when it is not used in accordance with these instructions.

The following safety instructions may appear in this manual:

► **ATTENTION**

This notice indicates potentially hazardous situations which, if not avoided, may result in property damage.

⚠ **CAUTION**

This notice indicates potentially hazardous situations which, if not avoided, may result in slight or minor injuries!

⚠ **WARNING**

This notice indicates potentially hazardous situations which, if not avoided, may result in death or serious injuries!

⚠ **DANGER**

This notice indicates potentially hazardous situations which, if not avoided, will result in death or serious injuries!

ⓘ **NOTICE**

This notice indicates further useful information.

Retain these instructions in a safe place for future reference, maintenance or when ordering replacement parts.

1.1 Technical Data

LCD - Display of:

- + Time
- + Distance
- + Speed
- + Watt
- + Rotations per Minute
- + Calories
- + Heart rate (when using hand pulse sensors or chest strap)

Braking system: electronically adjustable magnetic brake
Resistance level: 24

Stride length: 39 cm
Stride height: 18 cm
Stride width: 10 cm

Programmes in total: 18
Manual programmes: 1
Pre-set programmes: 12
Heart rate controlled programmes: 4
Watt controlled programmes: 1

Recovery Heart Rate Test: 1
Body Fat Test: 1

Weight and Dimensions:

Packing dimensions (L x W x H) approx.: 145 cm x 46 cm x 76 cm
Set-up dimensions (L x W x H) approx.: 145 cm x 52 cm x 160 cm
Article weight (incl. packaging) approx.: 56 kg
Article weight (excl. packaging) approx.: 47 kg

User weight: 120 kg

1.2 Personal Safety

DANGER

- + Before you start using the equipment, you should consult your physician that this type of exercise is suitable for you from a health perspective. Particularly affected are persons who: have a hereditary disposition to high blood pressure or heart disease, are over the age of 45, smoke, have high cholesterol values, are overweight and/or have not exercised regularly in the past year. If you are under medical treatment that affects your heart rate, medical advice is absolutely essential.
- + Note that excessive training can seriously endanger your health. Please also note that heart rate monitoring systems can be inaccurate. If you notice any signs of weakness, nausea, dizziness, pain, shortness of breath, or other abnormal symptoms, stop exercising immediately and seek advice from your doctor if necessary.

WARNING

- + This equipment may not be used by children under the age of 14.
- + Children should not be allowed unsupervised access to the equipment.
- + Persons with disabilities must have a medical license and must be under strict observation when using the equipment.
- + The equipment is strictly for use by one person at a time.
- + If your equipment provides a safety key, the clip of the safety key must be attached to your clothing before starting your training. In the event of a fall, the EMERGENCY STOP of the equipment can be initiated.
- + Keep your hands, feet and other body parts, hair, clothing, jewellery and other objects well clear of moving parts.
- + During use, wear suitable sports clothing rather than loose or baggy clothing. When wearing sports shoes, make sure they have suitable soles, preferably made of rubber or other non-slip materials. Shoes with heels, leather soles, studs or spikes are unsuitable. Never exercise barefoot.

CAUTION

- + If your equipment needs to be connected to the power supply with a mains cable, make sure that the cable is not a potential tripping hazard.
- + Make sure that nobody is within the range of motion of the equipment during training so as not to endanger you or other persons.

ATTENTION

- + Do not insert any objects of any kind into the openings of the device.

1.3 Electrical Safety

DANGER

- + In order to reduce the risk of an electric shock, always unplug the equipment from the mains socket immediately after your workout, before assembly or dismantling, and before maintenance or cleaning. Do not pull on the cable.

WARNING

- + Do not leave the equipment unattended while the mains cable is plugged into the mains socket. During your absence, the mains cable must be removed from the mains socket to prevent improper use by third parties or children.
- + If the mains cable or plug is damaged or defective, contact your contract partner. Until repair, the equipment must not be used.

ATTENTION

- + The equipment requires a mains connection of 220-230 V with 50 Hz mains voltage.
- + The equipment may only be connected directly to an earthed socket using the supplied mains cable. Extension cables must conform to VDE guidelines. Always completely unwind the mains cable.
- + The socket must be protected by a fuse with a minimum fuse rating of "16 A, slow blow".
- + Do not make any changes to the mains cable or the mains plug.
- + Keep the mains cable away from water, heat, oil and sharp edges. Do not route the mains cable underneath the equipment or under a carpet or rug, and do not place any objects on top of it.
- + If your purchased item is equipped with a TFT console, software updates must be carried out regularly. Follow the instructions on the console to perform the update(s).
- + The software systems on gym equipment with TFT consoles are set up only for the pre-installed apps. Do not install any additional apps.

NOTICE

- + The pre-installed apps on TFT consoles are produced and provided by external manufacturers. Sport-Tiedje does not take any responsibility for the availability, functionality or contents of these apps.

1.4 Set-Up Place



WARNING

- + Do not place the equipment in main corridors or escape routes.



CAUTION

- + Choose a location in which to place the equipment such that there is enough free space/clearance to the front, the rear and to the sides of the equipment.
- + The training room should be well ventilated during training and not be exposed to any draughts.
- + Choose the place in which to set up the equipment such that there is enough free space/clearance to the front, the rear and to the sides of the equipment.
- + The set-up and mounting surface of the equipment should be flat, loadable and solid.



ATTENTION

- + The device may only be used in one building, in sufficiently tempered and dry rooms (ambient temperatures between 10°C and 35°C). The equipment should not be used outdoors or in rooms with high humidity (over 70%) like swimming pools.
- + A floor protective mat/equipment underlay can help to protect high-quality floor coverings (parquet, laminate, cork, carpets) from dents and sweat and can help to level out slight unevenness.

2

ASSEMBLY

2.1 General Instructions



DANGER

- + Do not leave any tools, packaging materials such as foils or small parts lying around, as otherwise there is a danger of suffocation for children. Keep children away from the equipment during assembly.



WARNING

- + Pay attention to the instructions attached to the equipment in order to reduce the risk of injuries.



CAUTION

- + Ensure to have sufficient room for movement in each direction during assembly.
- + The assembly of the equipment must be carried out by at least two adults. If in doubt, seek the help of a third technically skilled person.



ATTENTION

- + To prevent damage to the equipment and the floor, assemble the equipment on a mat or packaging board.



NOTICE

- + In order to make the assembly as simple as possible, some screws and nuts to be used can already be pre-assembled.
- + Ideally, assemble the equipment at its later set-up place.

2.2 Scope of Delivery

The scope of delivery consist of the following parts. At the beginning, check whether all parts and tools belonging to the device are included in the scope of delivery and whether damage has occurred. In the event of complaints, the contractual partner must be contacted directly.

CAUTION

If parts of the scope of delivery are missing or damaged, the assembly must not be carried out.

Step 1:

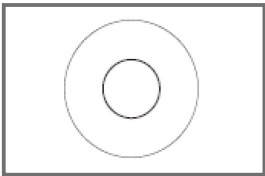

#104-1
8.7x20x1.5T
Flat Washer (2x)

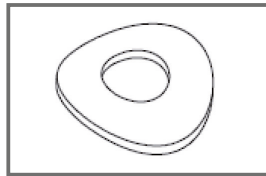

#112
3/8"x23x1.5T
Curved Washer (2x)

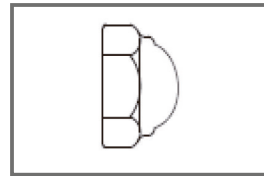

#96
3/8"
Cap Nut (2x)

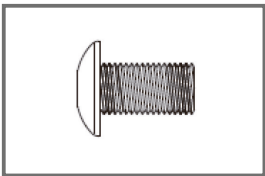

#80-1
5/16x15mm
Button Head Socket
Bolt (2x)

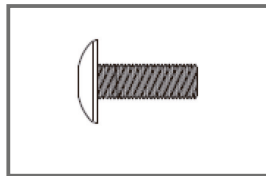

#82
M5x15mm
Phillips Head Screw
(4x)

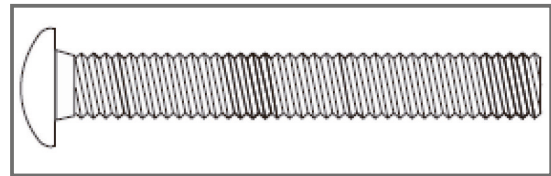

#77
3/8"x3"
Carriage Bolt (2x)

Step 2:

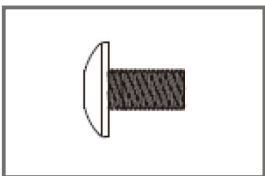

#84
M5x10mm
Phillips Head Screw (4x)

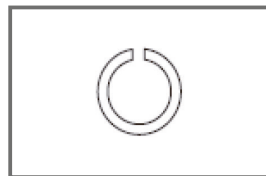

#111
5/16"x1.5T
Split Washer (6x)

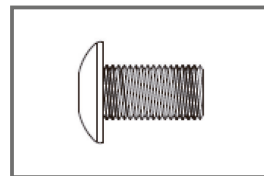

#80
5/16"x15mm
Button Head Socket Bolt (6x)

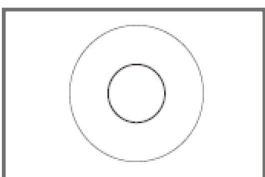

#105
5/16"x23x1.5T
Flat Washer (4x)

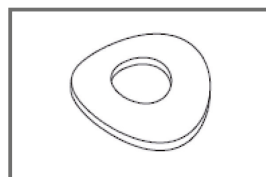

#113
5/16"x23x1.5T
Curved Washer (2x)

Step 3:

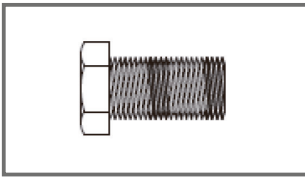

#74
5/16"x15mm
Hex Head Bolt (2x)

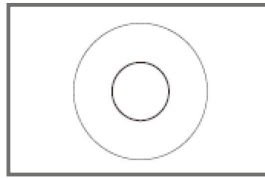

#102
8.7x20x1.5T
Flat Washer (2x)

Step 4:

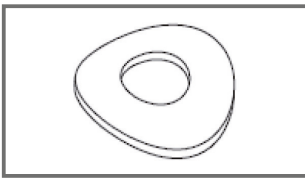

#113
5/16"x23x1.5T
Curved Washer (4x)

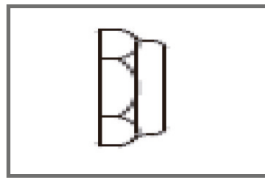

#91
5/16"x7T
Nyloc Nut (6x)

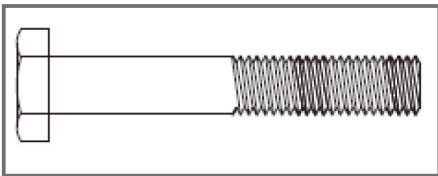

#76
5/16"x1-3/4"
Hex Head Bolt (6x)

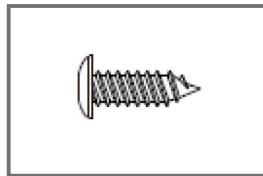

#87
3.5x12mm
Sheet Metal Screw (8x)

Tools

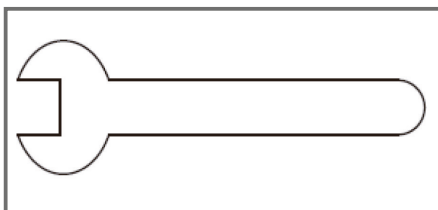

#116
12mm Wrench (1x)

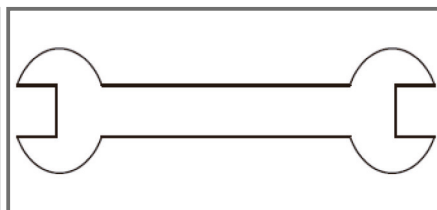

#115
13 & 14mm Wrench (1x)

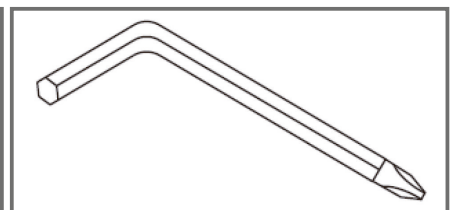

#118
5mm Allen Wrench & Phillips
Head Screw Driver (1x)

2.3 Assembly

Before assembly, take a close look at the individual assembly steps shown and carry out the assembly in the order given.

① NOTICE

- + First loosely screw all parts together and check that they fit properly. Tighten the screws using the tool only when you are instructed to do so.
- + If you have difficulty recognising the graphics, we recommend that you open and/or download the PDF instructions stored in the webshop on your end device (e.g. smartphone, tablet or PC). There you have the option of zooming in closer. Please note that the Adobe Acrobat Reader programme must be installed on your end device in order to open the file.

Step 1: Assembly of the Front Stabilizer and Connecting Arms

1. Mount the Front Stabilizer (14) to the plate, that is located on the lower end of the frame, with two Carriage Bolts (77), two Curved Washers (112) and two Cap Nuts (96). The transportation wheels must point forward.
2. Mount the two Slide Wheel Covers (65) to the left and right Pedal Arm (5 & 139) with four Phillips Head Screws (82).
3. Slide the shaft of the left Connecting Arm (7) into the socket of the left Pedal Arm (5) and mount it with one Button Head Socket Bolt (80-1) and one Flat Washer (104-1). Repeat this step for the right side.

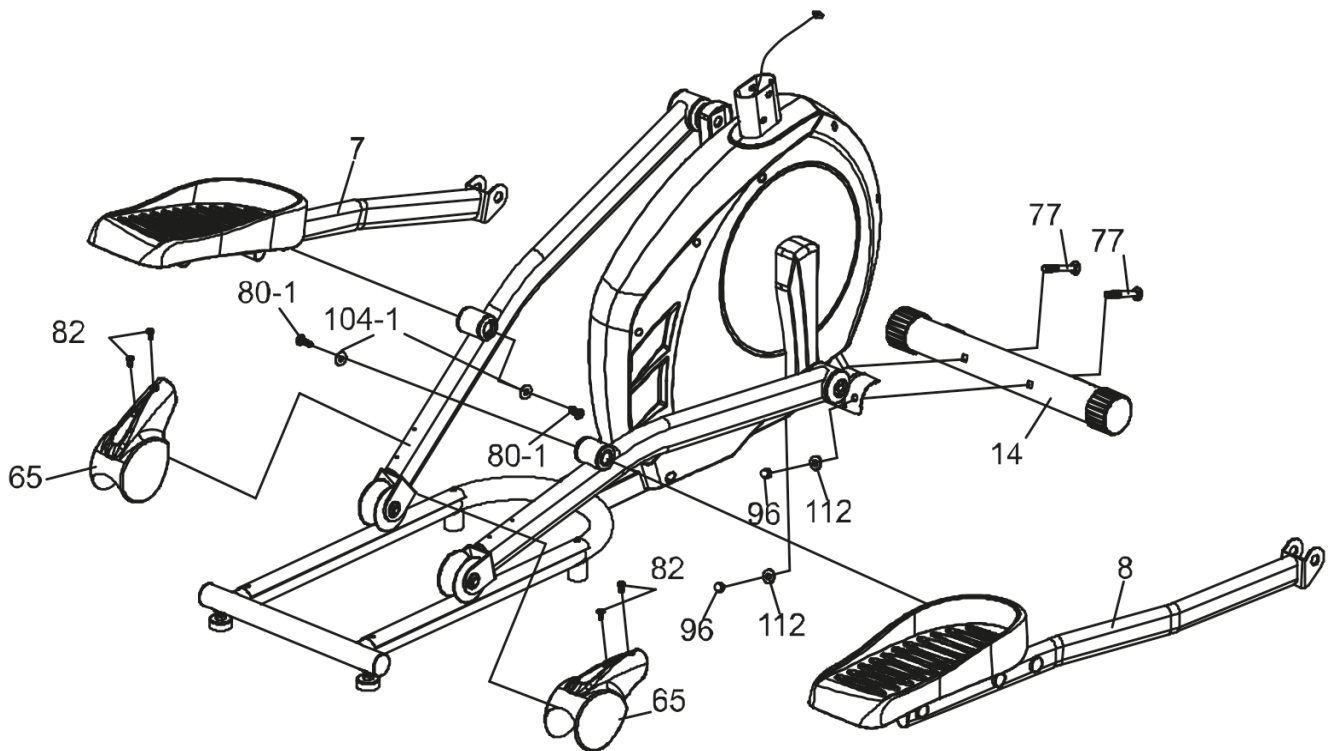

Step 2: Assembly of the Console Mast

1. Guide the Computer Cable (36) with the cable ties through the Console Mast (11) and pull it through the console bracket plate.
2. Insert the Console Mast (11) into the frame and mount it with six Button Head Socket Bolts (80), six Split Washers (111), four Flat Washers (105) and two Curved Washers (113).
3. Remove the cable ties from the Computer Cable (36) and insert the Computer Cable (36) and the two Handpulse Cables (40) into the Console (35).
4. Mount the Console (35) to the bracket plate with four Phillips Head Screws (84). Make sure to not pinch the cables.

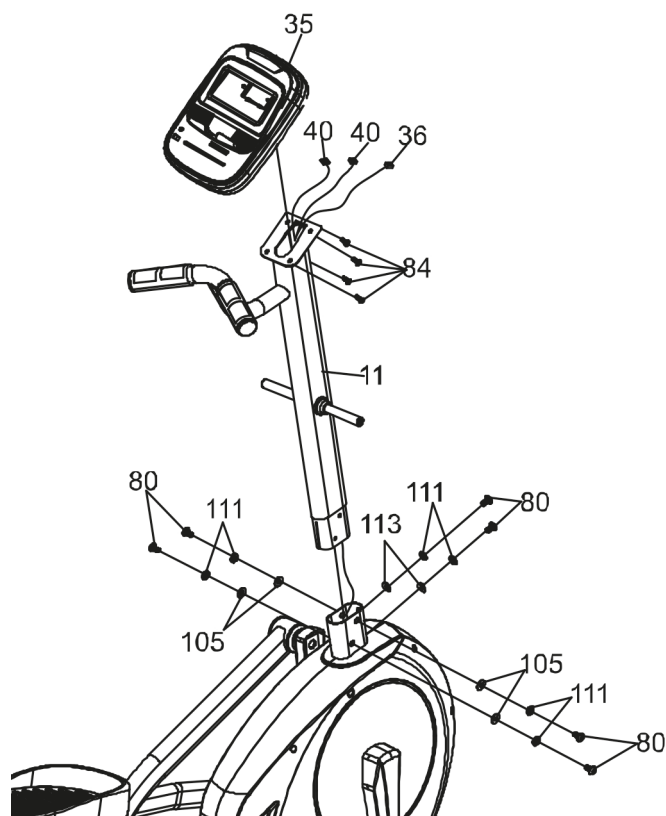

Step 3: Assembly of the Lower Handle Bars

1. Mount the left Lower Handle Bar (9) to the left shaft and the right Lower Handle Bar (10) to the right shaft of the Console Mast (11) with two Hex Head Bolts (74) and two Flat Washers (102).
2. Loosen the Rod End Shaft (18) from the two Connecting Arms. Mount the Lower Handle Bars (9 & 10) to the Connecting Arms each with one Rod End Shaft (18), one Hex Head Bolt (142) and one Flat Washer (105-1).

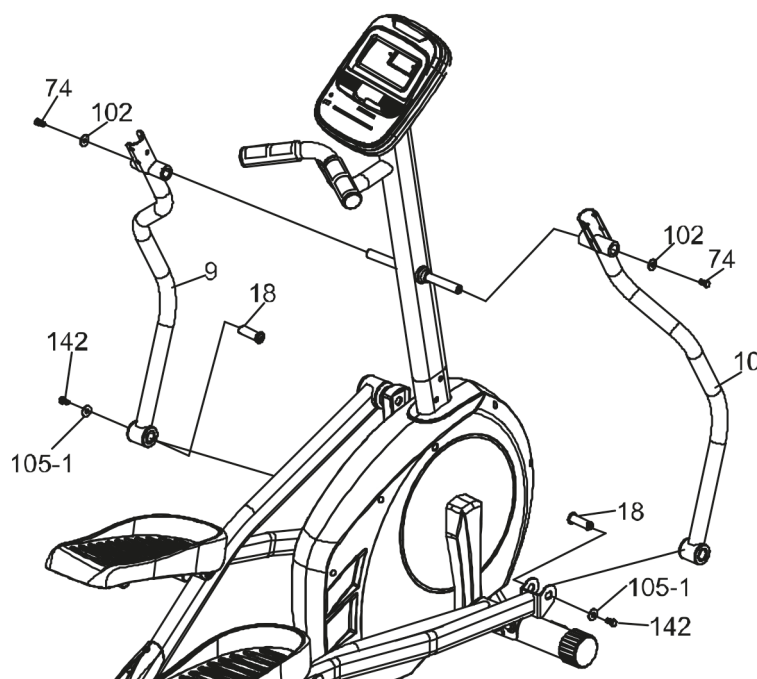

Step 4: Assembly of the Swing Arms

1. Mount the left and right Swing Arm (15 & 16) to the Lower Handlebars with six Hex Head Bolts (76), four Curved Washers (113) and six Nyloc Nuts (91).
2. Mount the left Front Handle Bar Cover (69) together with the left Rear Handle Bar Cover (69-1) to the left Lower Handle Bar with three Sheet Metal Screws (87). Repeat this step for the other side.
3. Mount the left and right Console Mast Cover (42 & 43) to the Console Mast (11) with two Sheet Metal Screws (87).

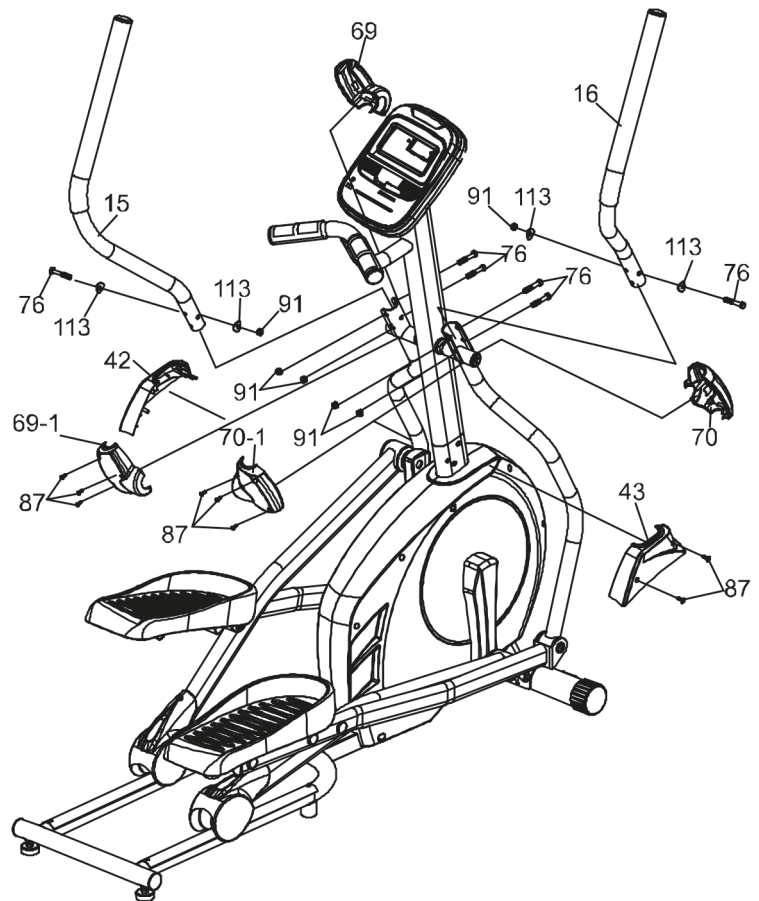

Step 5: Alignment of the feet

If the floor is uneven, you can stabilize the equipment by turning the two setting screws under the main frame.

1. Lift the equipment on the desired side and rotate the setting screws under the main frame.
2. Rotate the screws clockwise in order to remove them and to raise the equipment.
3. Rotate them counterclockwise in order to lower the equipment.

Step 6: Connecting the equipment to the mains supply

► **ATTENTION**

The equipment must not be connected to a multiple socket, otherwise it cannot be guaranteed that the equipment will be supplied with sufficient power. Technical errors can result.

Plug the power plug into a wall outlet that complies with the instructions in the chapter on electrical safety.

3 OPERATING INSTRUCTIONS

① NOTICE

Familiarise yourself with all the functions and setting options of the device before starting training. Have the proper use of this product explained to you by a specialist.

3.1 Console Display



Display	Description
Time	<ul style="list-style-type: none">+ Display of the training time+ Display range: 00:00–99:59+ Setting range: 00:00–99:00 (1-Minute-Steps)
Speed	<ul style="list-style-type: none">+ Display of the current training speed+ Display range: 0.0–99.8 km/h
RPM (Rotations per Minute)	<ul style="list-style-type: none">+ Display of the rotations per minute+ Display range: 0–15–999

Watt/Load	<ul style="list-style-type: none"> + Display of the current Wattage or resistance level + Display range: 0–999 or 0–24
Pulse	<ul style="list-style-type: none"> + Display of the current heart rate + Setting range: 0–30–230
Distance	<ul style="list-style-type: none"> + Display of the training distance + Display range: 0.00–99.99 km + Setting range: 0.00–99.90 km (0.1-km-Steps)
Calories	<ul style="list-style-type: none"> + Display of the burned calories + Display range: 0–9999 kcal + Setting range: 0–9990 kcal (10-kcal-Steps)
Programmes	<ul style="list-style-type: none"> + Manual programme (MANUAL) + 12 Pre-set programmes (BEGINNER 1–4, ADVANCE 1–4, SPORTY 1–4) + 4 Heart rate controlled programmes (CARDIO) + Watt controlled programmes (WATT)

3.2 Button Functions

Button	Description
RECOVERY	+ Test the recovery heart rate
BODY FAT	+ Start the body fat measurement
MODE	+ Confirm an entry or selection
START / STOP	+ Start or pause the training
UP	<ul style="list-style-type: none"> + Increase setting values + Select a programme
DOWN	<ul style="list-style-type: none"> + Decrease setting values + Select a programme
RESET	<ul style="list-style-type: none"> + Return to the main menu within the pause programme + Press and hold for 2 Sec. to restart the console

3.3 Switch On

After connecting the equipment to the power supply, the entire display will light up for about 2 seconds (Fig. 1).

NOTICE

After 4 minutes of no input or signal input, the console will go into power saving mode. Press any key to exit the power saving mode.

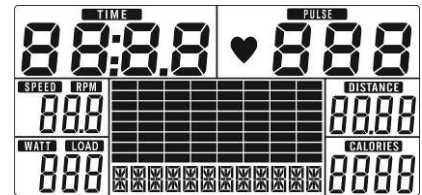

Fig. 1

3.4 Programmes

A total of 18 programmes are available to you:

- + Manual programme
- + 12 pre-set programmes
- + 4 heart rate controlled programmes
- + Watt-controlled programme

3.4.1 Manual Programme (MANUAL)

1. Select the manual programme (MANUAL) in the main menu with the UP/DOWN buttons and confirm the selection with the MODE button (Fig. 2)
2. To set the values for TIME, DISTANCE, CALORIES and PULSE, use the UP/DOWN buttons and confirm each entry with the MODE button (Fig. 3-6).
3. To start the programme, press the START/STOP button (Fig. 7).

NOTICE

During the training, you can adjust the resistance level with the UP/DOWN buttons. If no adjustment is made for 3 seconds, the display returns to the watt display.

4. To pause the programme, press the START/STOP button again.
5. To end the programme, press the RESET button while the programme is paused.



Fig. 2



Fig. 3



Fig. 4



Fig. 5



Fig. 6

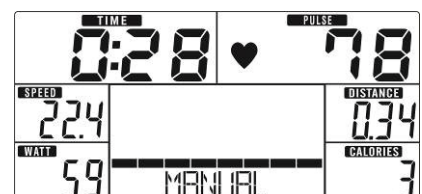

Fig. 7

3.4.2 Pre-Set Programmes (BEGINNER, ADVANCE, SPORTY)

1. Select one of the pre-set programme areas (BEGINNER, ADVANCE, SPORTY) with the UP/DOWN buttons and confirm the selection with the MODE button (Fig. 8–10).
2. Select one of the pre-set programmes (1–4) with the UP/DOWN buttons and confirm the selection with the MODE button (Fig. 11–13).
3. Set the TIME with the UP/DOWN buttons and confirm the entry with the MODE button.
4. To start the programme, press the START/STOP button.

NOTICE

During the training, you can adjust the resistance level with the UP/DOWN buttons. If no adjustment is made for 3 seconds, the display returns to the watt display.

5. To pause the programme, press the START/STOP button again.
6. To end the programme, press the RESET button while the programme is paused.

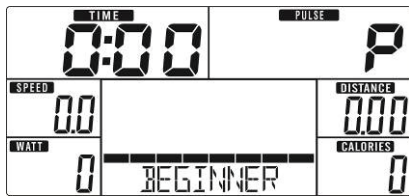

Fig. 8

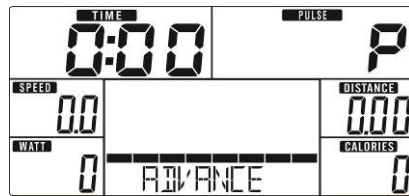

Fig. 9

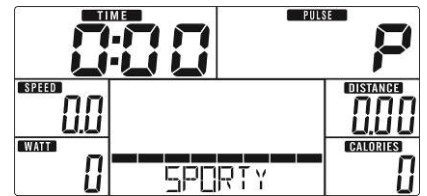

Fig. 10

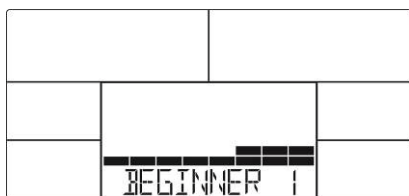

Fig. 11

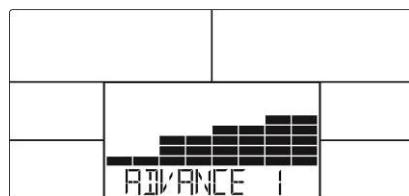

Fig. 12

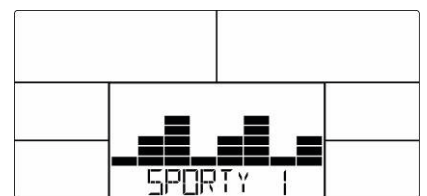

Fig. 13

Programme sequences:



3.4.3 Heart Rate Controlled Programmes (CARDIO)

WARNING

Your training equipment is not a medical device. The heart rate measurement of this equipment may be inaccurate. Various factors can affect the accuracy of the heart rate measurement. The heart rate measurement serves only as a training aid.

A total of four heart rate programmes are available. Either select one of the three pre-set target heart rates (55%, 75% or 90% of your maximum heart rate) or select TAG and manually enter a new target heart rate. Your maximum heart rate is determined by the console depending on your age. For these programmes we recommend using a chest strap.

1. Select the heart rate controlled programme (CARDIO) with the UP/DOWN buttons in the main menu and confirm the selection with the MODE button (Fig. 14).
2. Set your AGE with the UP/DOWN buttons and confirm the entry with the MODE button (Fig. 15).
3. Select with the UP/DOWN buttons 55% (Fig. 16), 75%, 90% or select TAG to set a target heart rate. Confirm the selection with the MODE button.
- 3.1. If you have chosen TAG, set your target heart rate with the UP/DOWN buttons and confirm with the MODE button.
4. Set the TIME with the UP/DOWN buttons and confirm the entry with the MODE button.
5. To start the programme, press the START/STOP button.

NOTICE

- + During the training, you can adjust the resistance level with the UP/DOWN buttons. If no adjustment is made for 3 seconds, the display returns to the watt display.
 - + As soon as your heart rate is above the target heart rate, a signal sounds.
6. To pause the programme, press the START/STOP button again.
 7. To end the programme, press the RESET button while the programme is paused.



Fig. 14

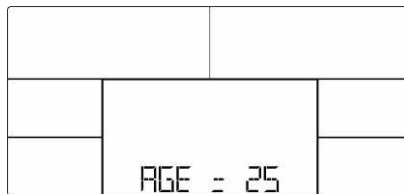

Fig. 15



Fig. 16

3.4.4 Watt-controlled Programme (WATT)

1. Select the watt controlled program (WATT) in the main menu with the UP/DOWN buttons and confirm the selection with the MODE button (Fig. 17).
2. Set the desired watt value with the UP/DOWN buttons and confirm with the MODE button (Fig. 18).

NOTICE

The default watt value is 120.

3. Set the TIME with the UP/DOWN buttons and confirm the entry with the MODE button.
4. To start the programme, press the START/STOP button.

NOTICE

During the training, you can adjust the watt value with the UP/DOWN buttons.

5. To pause the programme, press the START/STOP button again.
6. To end the programme, press the RESET button while the programme is paused.

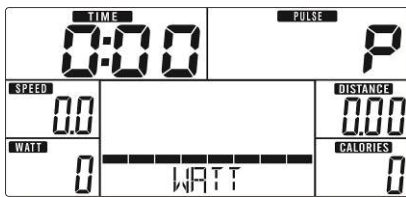

Fig. 17

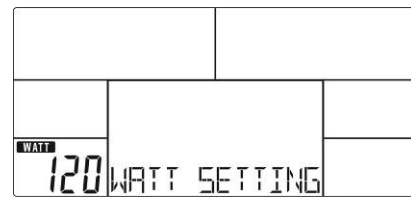

Fig. 18

3.5 Recovery Heart Rate Test

After a training session, you can measure the recovery heart rate. Press the RECOVERY button after the training and hold the hand pulse sensors or wear a chest strap. All functions on the display stop and the time display counts down from 00:60 to 00:00. After the time has elapsed, a value between F1 and F6 is displayed:

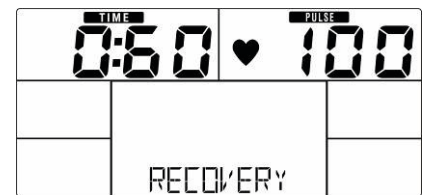

Fig. 19



Fig. 20

Value	Description
F1	Very good
F2	Well
F3	Average
F4	Sufficient
F5	Bad
F6	Very bad

3.6 Body Fat Test

1. To start the body fat test, press the BODY FAT button in the main menu.
2. Use the UP/DOWN buttons to set your SEX, AGE, HEIGHT and WEIGHT information and confirm each entry with the MODE button (Fig. 21).
3. Hold the hand pulse sensors for at least 8 seconds until the console has finished measuring.

The console will display a loading screen during the measurement (Fig. 22).

Once the measurement is complete, the display shows the body fat percentage (FAT) and BMI for 30 seconds (Fig. 23 and 24).

NOTICE

During or after the measurement, the following errors may occur and are shown in the display:

- + ==: Not enough contact to the hand pulse sensors or to the chest strap (Fig. 25)
- + E-1: The console is not receiving a heart rate signal
- + E-4: The value for body fat percentage and/or BMI is less than 5 or more than 50 (Fig. 26)

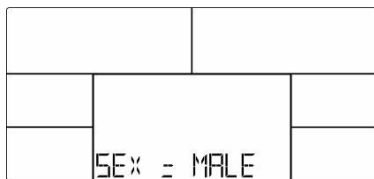

Fig. 21



Fig. 22

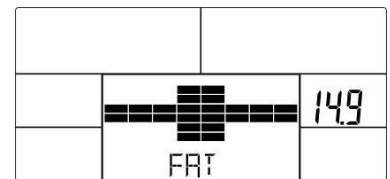

Fig. 23

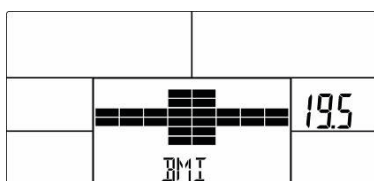

Fig. 24

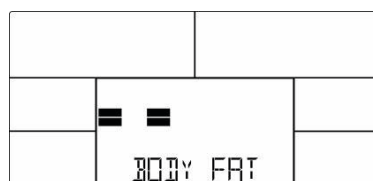

Fig. 25

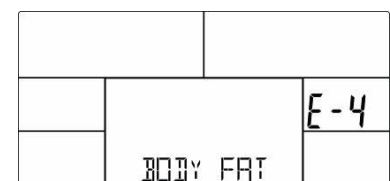

Fig. 26

4.1 General Instructions

WARNING

- + The storage location should be chosen so that improper use by third parties or children can be prevented.
- + If your equipment does not have transportation wheels, the equipment must be disassembled before transportation.

▶ ATTENTION

- + Make sure that the equipment is protected from moisture, dust and dirt in the selected storage location. The storage location should be dry and well ventilated and have a constant ambient temperature between 10°C and 35°C.

4.2 Transportation Wheels

▶ ATTENTION

If you want to transport your equipment over particularly sensitive and soft floor coverings, such as parquet, planks or laminate, lay out the transport route with cardboard or similar to avoid possible floor damage.

1. Stand behind the equipment and lift it until the weight is transferred to the transportation wheels. After that, you easily can move the equipment to a new position. For long transport distances the equipment should be disassembled and safely packed.
2. Select the new location by following the instructions in the section 1.4 of this manual.



5.1 General Instructions



WARNING

- + Do not make any improper changes to the equipment.



CAUTION

- + Damaged or worn components may affect your safety and the life of the equipment. Therefore, immediately replace damaged or worn components. In such a case, contact the contract partner. The equipment must not be used until it has been repaired. If necessary, use only original spare parts.



ATTENTION

- + In addition to the instructions and recommendations for maintenance and care given here, additional service and/or repair work may be necessary; this must only be carried out by authorised service technicians.

5.2 Faults and Fault Diagnosis

The equipment undergoes regular quality controls during production. Nevertheless, faults or malfunctions may occur. Frequently, individual parts are responsible for these disturbances, an exchange is usually sufficient. Please refer to the following overview for the most common errors and how to correct them. If the equipment still does not function properly, contact your contract partner.

Fault	Cause	Solution
Drive disks wobble/ make noises	Drive disk loose	Tighten nut (pay attention to left-hand / right-hand thread)
Display is blank/is not working	Loose cable connections	Check cable connections
Equipment wobbles	Equipment is not level	Align the feet
Creaking noises on the stepping area	Loose screws on stepping area	Tighten the screws on the stepping area
Creaking noises	Screw connections loosened or too tight	Check screw connections
Squeaking noises on the guide rails	Guide rails or rollers dirty or guide rails dry	Clean the guide rails and then lubricate them with a suitable lubricant

No pulse display	<ul style="list-style-type: none"> + Sources of interference in the room + unsuitable chest strap + Wrong position of chest strap + Chest strap defective or battery empty + Pulse display defective 	<ul style="list-style-type: none"> + Eliminate sources of interference (e.g. mobile phone, WLAN, lawn mower and vacuum cleaner robot, etc. ...) + Use a suitable chest strap (see RECOMMENDED ACCESSORIES). + Reposition chest strap and/or moisten electrodes + Changing batteries + Check if pulse display by hand pulse possible
------------------	---	--

5.3 Error Codes and Troubleshooting

The electronics of the equipment continuously carries out tests. In case of deviations, an error code appears on the display and normal operation is stopped for your safety.

- + = =: Not enough contact to the han pulse sensors or to the chest strap.
Grasp the hand pulse sensors completely or reposition the chest strap.
- + E-1: The console is not receiving a heart rate signal.
Check the cable connections.
- + E-4: Body fat percentage and/or BMI value is less than 5 or more than 50
Check your entries for age, height and weight.

Please contact Sport-Tiedje for technical support.

5.4 Maintenance and Inspection Calendar

To avoid damage from body sweat, the equipment must be cleaned with a damp towel (no solvents!) after each training session.

The following routine tasks must be performed at the specified intervals:

Part	Weekly	Monthly	Quarterly
Display console	C	I	
Slide rails*		C	
Lubrication of slide rails and moving parts*			I
Plastic covers	C	I	
Screws and cable connections		I	
Legend: C = clean; I = inspect			

*Make sure to always clean the slide rails and moving parts before re-lubricating.

By scanning the QR code with the camera function or QR code scanner app of your smartphone/tablet, a video on general maintenance of a crosstrainer opens on YouTube. The video serves to illustrate the maintenance points described in this manual.



Please note that the video may not be available in your language or with appropriate subtitles.

If you cannot scan QR codes, you can access all Sport-Tiedje videos on YouTube by first opening YouTube and entering "Sport-Tiedje" in the search field.

6 DISPOSAL

At the end of its operational life, this equipment cannot be disposed of in normal household waste. Instead, it must be disposed of via an electricals recycling centre. Further information can be obtained from your local authority's recycling service.



The materials can be recycled as per their symbols. Through the reuse, recycling of materials or other forms of recovery of old equipment, you make an important contribution to the protection of the environment.

To make your training experience even more efficient and pleasant, we recommend that you add suiting accessories to your fitness equipment. This could be a floor mat, for example, which makes your fitness equipment stand more securely and also protects the floor from falling sweat, but it could also be additional handrails on some treadmills or silicone spray to keep moving parts in good shape.

If you have purchased a fitness machine with pulse training and want to train your heart rate, we strongly recommend that you use a compatible chest strap, as this ensures optimum transmission of the heart rate. You may want to buy additional grips or weights for multi gyms.

Our range of accessories offers the highest quality and makes training ever better. If you would like to find out more about compatible accessories please go to the detail page of the product in our webshop (the easiest way is to enter the article number in the search field above) and go to the recommended accessories on this page. Of course, you can also contact our customer service: by telephone, e-mail, in one of our branches or via our social media channels. We will be happy to advise you!



floor mat



chest strap



chest strap contact gel



towels



silicone spray

8.1 Serial Number and Model Name

In order to provide you with the best possible service, please have the model name, article number, serial number, exploded drawing and parts list ready. The corresponding contact options can be found in chapter 10 of this operating manual.

NOTICE

The serial number of your equipment is unique. It's located on a white sticker. The exact position of this sticker is shown in the following illustration.



Enter the serial number in the appropriate field.

Serial number:

Brand / Category:

Model Name:

Article Number:

8.2 Parts List

No.	Name	Qty.	No.	Name	Qty.
1	Main Frame	1	42	Console Mast Cover (L)	1
3	Crank Arm Assembly	2	43	Console Mast Cover (R)	1
5	Pedal Arm(L)	1	44	Transportation Wheel	2
7	Connecting Arm (L)	1	46	Round End Cap	2
8	Connecting Arm (R)	1	47	Slide Wheel , Urethane	2
9	Lower Handle Bar (L)	1	48	Adjustment Foot Pad	2
10	Lower Handle Bar (R)	1	49	WFM-1719-12_Bushing	4
11	Console Mast	1	50	J4FM-1719-09_Bushing	4
12	Idler Wheel Assembly	1	51	Drive Pulley	1
13	Crank Axle	1	52	Ø32(1.8T)_Button Head Plug	4
14	Front Stabilizer	1	53	Podwer metallurgy Bushing	4
15	Swing Arm (L)	1	54	Rubber Foot	2
16	Swing Arm (R)	1	55	Round Cap	2
18	Rod End Shaft(Blackfast)	2	56	Pedal Axle Spacer	2
19	Axle for Slide Wheel(Blackfast)	2	57	Spacer Bushing	1
22	Aluminum Track	2	58	Side Case(L)	1
23	6005_Bearing	1	59	Side Case(R)	1
24	6003_Bearing	4	60	Crank Arm End Cap	2
25	Axle for Idler Wheel	1	61	Ø56 × Ø19 × 15L_Bushing	2
27	Belt	1	62	Ø56 × Ø19 × 21L_Bushing	2
28	Flywheel	1	63	Pedal (L)	1
29	Magnet	1	64	Pedal (R)	1
30	Handgrip Foam	2	65	Slide Wheel Cover	2
31	Steel Cable	1	66	Ø42 × Ø19 × 15L_Bushing	4
35	Console Assembly	1	67	Pedal Bushing	4
36	1600m/m_Computer Cable	1	68	Bolt Access Cap	1
37	450m/m_DC Power Cord	1	69	Front Handle Bar Cover (L)	1
38	Gear Motor	1	69~1	Rear Handle Bar Cover (L)	1
39	200m/m_Sensor W/Cable	1	70	Front Handle Bar Cover (R)	1
40	800m/m_Handpulse W/Cable Assembly	2	70~1	Rear Handle Bar Cover (R)	1
41	Power Adaptor	1	73	1/4" × UNC20 × 3/4" _Hex Head Bolt	4

74	5/16" × UNC18 × 15L_Hex Head Bolt	8	104~1	Ø8.7 × Ø20 × 1.5T_Flat Washer	2
			105	Ø8 × 23 × 1.5T_Flat Washer	11
75	5/16" × UNC18 × 15L_Hex Head Bolt	2	105~1	5/16" × 23 × 3T_Flat Washer	4
			107	Ø15.8 × Ø10 × 9L_Sleeve	1
76	5/16" × UNC18 × 1-3/4" _Hex Head Bolt	6	108	M8 × P1.25 × 130L_J Bolt	1
			109	M8 × P1.25 × 20L_Carriage Bolt	1
77	3/8" × UNC16 × 3" _Carriage Bolt	2	111	Ø8 × 1.5T_Split Washer	6
78	3/8" × UNC16 × 28L_Carriage Bolt	1	112	Ø10 × 23 × 1.5T_Curved Washer	2
			113	Ø8 × 23 × 1.5T_Curved Washer	6
79	M8 × P1.25 × 25L_Socket Head Cap Bolt	2	114	Woodruff Key	2
			115	13/14m/m_Wrench	1
80	5/16" × UNC18 × 15L_Button Head Socket Bolt	6	116	12m/m_Wrench	1
			118	Combination M5 Allen Wrench & Phillips Head Screw Driver	1
80~1	5/16" × UNC18 × 15L_Button Head Socket Bolt	2	119	Ø8 × 16 × 1T_Flat Washer	1
82	M5 × P0.8 × 15L_Phillips Head Screw	4	120	Ø5 × 16 × 1.5T_Flat Washer	1
			134	M6 × P1.0 × 15L_Phillips Head Screw	4
83	M5 × P0.8 × 10L_Phillips Head Screw	10	135	Oval End Cap	2
			136	Round Cap	8
84	M5 × P0.8 × 10L_Phillips Head Screw	4	137	C Ring	2
85	Ø5 × 19L_Tapping Screw	9	138	Ø15 × Ø8.5 × 50L_Sleeve	2
85~1	Ø5 × 19L_Tapping Screw	4	139	Pedal Arm(R)	1
86	Ø3.5 × 16L_Sheet Metal Screw	9	142	5/16" × 15L_Hex Head Bolt	4
87	Ø3.5 × 12L_Sheet Metal Screw	8	143	6005-2RS/B10+2M5_Bearing	1
88	Ø3 × 20L_Tapping Screw	4			
90	3/8" × UNC16 × 7T_Nyloc Nut	1			
91	5/16" × UNC18 × 7T_Nyloc Nut	6			
92	M8 × P1.25 × 7T_Nyloc Nut	1			
93	M8 × P1.25 × 9T_Nyloc Nut	1			
94	1/4" × UNC20 × 8T_Nyloc Nut	4			
96	3/8" × UNC16 × 12.5T_Cap Nut	2			
97	3/8" -UNF26 × 4T_Nut	2			
98	3/8"-UNF26 × 11T_Nut	2			
99	3/8" × UNC16 × 7T_Nut	2			
102	Ø8.7 × Ø20 × 1.5T_Flat Washer	2			
103	Ø8 × Ø35 × 1.5T_Flat Washer	2			
104	Ø8.5 × 26 × 2.0T_Flat Washer	2			

8.3 Exploded Drawing

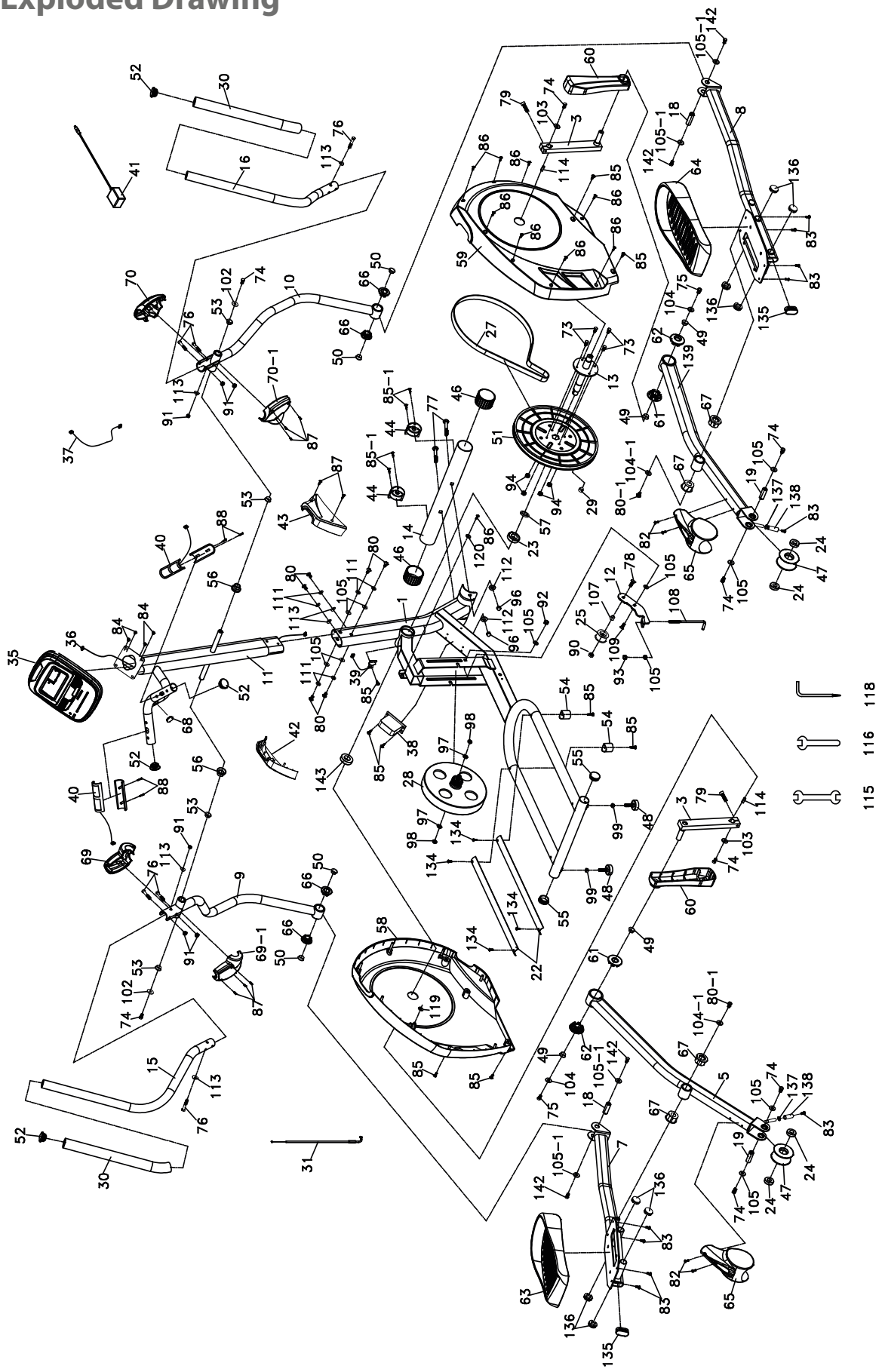

Training equipment from Taurus® is subject to strict quality control. However, if a fitness equipment purchased from us does not work perfectly, we take it very seriously and ask you to contact our customer service as indicated. We are happy to help you by phone via our service hotline.

Error Descriptions

Your fitness equipment is developed for long-term, high-quality training. However, should a problem arise, please first read the operating instructions. For further assistance, please contact your contract partner or call our service hotline. To ensure your problem is solved as quickly as possible, please describe the defect as exactly as possible.

In addition to the statutory warranty, we provide a warranty for every fitness equipment purchased from us according to the following provisions.

Your statutory rights are not affected.

Warranty

The warranty is the first/original buyer and/or any person who received a newly purchased product as a gift from the original buyer.

Warranty period

The warranty periods, shown on our web shop, begin on delivery of the fitness equipment. The respective warranty periods for your equipment can be found on its product website.

Repair Costs

According to our choice, there will either be a repair, a replacement of individual damaged parts or a complete replacement. Spare parts, that have to be mounted while assembling the equipment, have to be replaced by the warranty personally and are not a part of repair. After the expiration of the warranty period for repair costs, a pure parts warranty applies, which does not include the repair, installation and delivery costs.

The terms of use are defined as follows:

- + Home use: solely for private use in private households up to 3 hours per day
- + Semi-professional use: up to 6 hours per day (e. g. rehabilitation centres, hotels, clubs, company gyms)
- + Professional use: more than 6 hours per day (e. g. commercial gyms)

Warranty Service

Within the warranty period, equipment which develops faults as a result of material or manufacturing defects, will be repaired or replaced at our discretion. Ownership of equipment or parts of equipment which have been replaced is transferred to us. The warranty period is not extended nor does a new warranty period begin following repair or replacement under the warranty.

Warranty Conditions

For the warranty to be valid, the following steps must be taken:

Please contact our customer service by email or phone. If the product under warranty has to be sent in for repair, the seller bears costs. After expiry of the warranty, the buyer bears the costs of transport and insurance. If the fault is covered by our warranty, you will receive a new or repaired equipment in return.

Warranty claims are invalid in case of damage resulting from:

- + misuse or improper handling
- + environmental influences (moisture, heat, electrical surge, dust, etc.)
- + failure to follow the current safety measures for the equipment
- + failure to follow the operating instructions
- + use of force (e. g. hitting, kicking, falling)
- + interventions which were not carried out by one of our authorized service centres
- + unauthorised repair attempts

Proof of Purchase and Serial Number

Please make sure that you are able to provide the appropriate receipt when claiming on your warranty. So that we can clearly identify the model of your equipment, and for the purposes of our quality control, you will need to give the serial number of your equipment, when contacting the service team. Where possible please have your serial number and your customer number ready when you call our service hotline. It will help us to deal with your request swiftly.

If you cannot find the serial number on your fitness equipment, our service team is at your disposal to offer further information.

Service outside of the Warranty Period

We are also happy to issue an individual cost estimate if there is a problem with your fitness equipment after the warranty has expired, or in cases which do not fall under the terms of the warranty, e. g. normal wear and tear. Please contact our customer service team to find a quick and cost-effective solution to your problem. In such a case you will be responsible for the delivery costs.

Communication

Many problems can be solved just by speaking to us as your specialist supplier. We know how important it is to you as a user of the fitness equipment to have problems solved quickly and simply, so you can enjoy working out with minimal interruption. For that reason, we also want to resolve your queries quickly and in a straightforward manner. Thus, please always keep your customer number and the serial number of the faulty equipment handy.

DE		DK	FR
TECHNICAL SUPPORT +49 4621 4210-900 +49 4621 4210-698 technik@sport-tiedje.de Mo - Fr 08:00 - 18:00 Sa 09:00 - 18:00		TECHNICAL SUPPORT & SERVICE 80 90 16 50 +49 4621 4210-945 info@fitshop.dk Mo - Fr 08:00 - 18:00 Sa 09:00 - 18:00	TECHNICAL SUPPORT & SERVICE +33 (0) 172 770033 +49 4621 4210-933 service-france@fitshop.fr Mo - Fr 08:00 - 18:00 Sa 09:00 - 18:00
SERVICE 0800 20 20277 (Freecall) info@sport-tiedje.de Mo - Fr 08:00 - 21:00 Sa 09:00 - 21:00 So 10:00 - 18:00		PL	
		TECHNICAL SUPPORT & SERVICE 22 307 43 21 +49 4621 42 10-948 info@fitshop.pl Mo - Fr 08:00 - 18:00 Sa 09:00 - 18:00	BE
			TECHNICAL SUPPORT & SERVICE 02 732 46 77 +49 4621 42 10-932 info@fitshop.be Mo - Fr 08:00 - 18:00 Sa 09:00 - 18:00

UK	NL	INT
TECHNICAL SUPPORT +44 141 876 3986 support@powerhousefitness.co.uk SERVICE +44 141 876 3972 Mo - Fr 9am - 5pm	TECHNICAL SUPPORT & SERVICE +31 172 619961 info@fitshop.nl Ma - Do 09:00 - 17:00 Vr 09:00 - 21:00 Za 10:00 - 17:00	TECHNICAL SUPPORT & SERVICE +49 4621 4210-944 service-int@sport-tiedje.de Mo - Fr 8am - 6pm Sat 9am - 6pm
	AT	
	TECHNICAL SUPPORT & SERVICE 0800 20 20277 (Freecall) +49 4621 42 10-0 info@sport-tiedje.at Mo - Fr 08:00 - 18:00 Sa 09:00 - 18:00	CH
		TECHNICAL SUPPORT & SERVICE 0800 202 027 +49 4621 42 10-0 info@sport-tiedje.ch Mo - Fr 08:00 - 18:00 Sa 09:00 - 18:00

Please find a detailed overview including address and opening hours for all stores of the Sport-Tiedje Group in Germany and abroad on the following website:

www.sport-tiedje.com/en/stores

WE LIVE FITNESS

WEBSHOP AND SOCIAL MEDIA

Sport-Tiedje is Europe's largest specialist store for home fitness equipment with currently over 70 stores and one of the world's most renowned online mail order companies for fitness equipment. Private customers order via the 25 web shops in the respective national language or have their desired equipment assembled on site. In addition, the company supplies fitness studios, hotels, sports clubs, companies and physio practices with professional equipment for endurance and strength training.

Sport-Tiedje offers a wide range of fitness equipment from renowned manufacturers, high-quality in-house developments and comprehensive services, such as a build-up service and sports scientific advice before and after the purchase. The company employs numerous sports scientists, fitness trainers and competitive athletes.

Visit us also on our social media platforms or our blog!

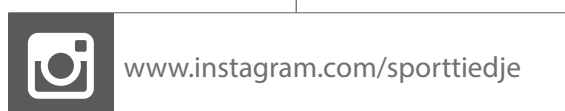



Elliptical Trainer **FX30**