

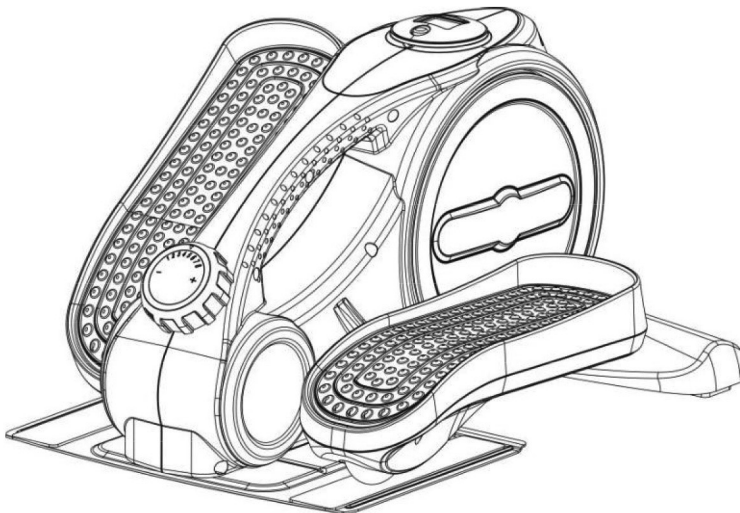

## Assembly and Operating Instructions



max. 100 kg



~ 15 Min.



9 kg

L 51 | W 41 | H 29

FSCSTMEP01.01

Art. No. CST-MEP

Mini Elliptical Trainer



# Content

<b>1</b>	<b>GENERAL INFORMATION</b>	<b>7</b>
1.1	Technical Data	7
1.2	Personal Safety	8
1.3	Set-Up Place	9
<b>2</b>	<b>ASSEMBLY</b>	<b>10</b>
2.1	General Instructions	10
2.2	Scope of Delivery	10
2.3	Assembly	11
2.4	Battery Replacement	12
<b>3</b>	<b>OPERATING INSTRUCTIONS</b>	<b>13</b>
3.1	Console Display	13
3.2	Button Functions	14
3.3	Start/Stop Training	14
<b>4</b>	<b>TROUBLESHOOTING, CARE AND MAINTENANCE</b>	<b>14</b>
4.1	General Instructions	14
4.2	Faults and Fault Diagnosis	15
4.3	Maintenance and Inspection Calendar	15
<b>5</b>	<b>DISPOSAL</b>	<b>15</b>
<b>6</b>	<b>ORDERING SPARE PARTS</b>	<b>16</b>
6.1	Serial Number and Model Name	16
6.2	Parts List	17
6.3	Exploded Drawing	18
<b>7</b>	<b>WARRANTY</b>	<b>18</b>
<b>8</b>	<b>CONTACT</b>	<b>19</b>



**Dear customer,**

thank you for choosing fitness equipment from cardiostrong®. cardiostrong offers high-quality home fitness equipment that is optimally adapted to the conditions at home. Train at home no matter what the weather or time of the day. cardiostrong fitness equipment offers training programmes and a variety of equipment for all training levels and all training goals.

Further information can be found at [www.fitshop.com/cardiostrong](http://www.fitshop.com/cardiostrong).

We hope you enjoy your training!

**Intended Use**

The equipment may only be used for its intended purpose.

The equipment is only suitable for home use. The equipment is not suitable for semi-professional (e.g. hospitals, associations, hotels, schools, etc.) and commercial or professional use (e.g. fitness studios).

**Legal Notice**

Fitshop GmbH  
Europe's No. 1 for home fitness

International Headquarters  
Flensburger Straße 55  
24837 Schleswig  
Germany

Management:  
Christian Grau  
Sebastian Campmann  
Dr. Bernhard Schenkel  
No. HRB 1000 SL  
Local Court Flensburg  
European VAT Number: DE813211547

**Disclaimer**

© cardiostrong is a registered brand of the company Fitshop GmbH. All rights reserved. Any use of this trademark without the explicit written permission of Fitshop is prohibited.

Product and manual are subject to change. Technical data can be changed without advance notice.

**FITSHOP**

Europe's No.1 for Home Fitness

## ABOUT THIS MANUAL

Please carefully read the entire manual before installation and first use. The manual will help you to quickly set up the system and explains how to safely use it. Make sure that all persons exercising with the equipment (especially children and persons with physical, sensory, mental or motor disabilities) are informed about this manual and its contents in advance. In case of doubt, responsible persons must supervise the use of the equipment.

Due to ongoing changes and software optimisations, the manual may have to be updated. If you notice any discrepancies during assembly or use, please refer to the manual uploaded to the webshop. The latest manual is always available there.



This equipment has been manufactured according to the latest safety knowledge. As far as possible, potential safety hazards which could cause injury have been eliminated. Make sure to carefully follow the instructions and that all parts are securely in place. If required, read through the instructions again to correct any mistakes.

Training devices must be classified according to accuracy and use. Accuracy classes are only applicable to devices that display training data.

### Accuracy classes

Class A: high accuracy.

Class B: medium accuracy.

Class C: low accuracy.

The use classes explain the intended use of the training device.

### Use classes

**Class S** (studio): professional and/or commercial use.

These training devices are intended for the use in training rooms of facilities such as sports clubs, school facilities, hotels, clubs and studios whose access and supervision is specifically regulated by the owner (person with legal responsibility).

**Class H** (home use): use at home.

These stationary training devices are intended for the use in private homes where access to the training device is regulated by the owner (person with legal responsibility).

Please pay close attention to the safety and maintenance instructions given here. The contract partner cannot be held liable for damage to health, accidents or damage to the equipment when it is not used in accordance with these instructions.

The following safety instructions may appear in this manual:

► **ATTENTION**

This notice indicates potentially hazardous situations which, if not avoided, may result in property damage.

⚠ **CAUTION**

This notice indicates potentially hazardous situations which, if not avoided, may result in slight or minor injuries!

⚠ **WARNING**

This notice indicates potentially hazardous situations which, if not avoided, may result in death or serious injuries!

⚠ **DANGER**

This notice indicates potentially hazardous situations which, if not avoided, will result in death or serious injuries!

ⓘ **NOTICE**

This notice indicates further useful information.

Retain these instructions in a safe place for future reference, maintenance or when ordering replacement parts.

## 1.1 Technical Data

Article weight (gross, incl. packaging):	11 kg/ 24.2 LBS
Article weight (net, without packaging):	9.3 kg/ 20.5LBS
Packaging dimensions (L x W x H):	56.5 cm x 46 cm x 37 cm
Set-up dimensions (L x W x H):	51 cm x 40.5 cm x 29 cm
Maximum user weight:	100 kg
Use class:	H



## 1.2 Personal Safety

### DANGER

- + Before you start using the equipment, you should consult your physician that this type of exercise is suitable for you from a health perspective. Particularly affected are persons who: have a hereditary disposition to high blood pressure or heart disease, are over the age of 45, smoke, have high cholesterol values, are overweight and/or have not exercised regularly in the past year. If you are under medical treatment that affects your heart rate, medical advice is absolutely essential.
- + Note that excessive training can seriously endanger your health. Please also note that heart rate monitoring systems can be inaccurate. If you notice any signs of weakness, nausea, dizziness, pain, shortness of breath, or other abnormal symptoms, stop exercising immediately and seek advice from your doctor if necessary.
- + The owner must communicate all warnings and instructions to the user.

### WARNING

- + This equipment may not be used by children under the age of 14.
- + Children should not be allowed unsupervised access to the equipment.
- + Persons with disabilities must have a medical license and must be under strict observation when using the equipment.
- + Remember that your device does not have a freewheel function. Therefore moving parts cannot be stopped immediately.
- + Note that the individual physical power required to perform an exercise may differ from the displayed mechanical power.
- + When ascending and descending, make sure that one of the treads is in the lowest position.
- + The equipment is strictly for use by one person at a time.
- + Keep your hands, feet and other body parts, hair, clothing, jewellery and other objects well clear of moving parts.
- + During use, wear suitable sports clothing rather than loose or baggy clothing. When wearing sports shoes, make sure they have suitable soles, preferably made of rubber or other non-slip materials. Shoes with heels, leather soles, studs or spikes are unsuitable. Never exercise barefoot.

### CAUTION

- + If your equipment needs to be connected to the power supply with a mains cable, make sure that the cable is not a potential tripping hazard.
- + Make sure that nobody is within the range of motion of the equipment during training so as not to endanger you or other persons.
- + Do not insert any objects of any kind into the openings of the device.
- + Be aware that if adjustment devices are left protruding, they may impede the user's movement.

## 1.3 Set-Up Place



### **WARNING**

- + Do not place the equipment in main corridors or escape routes.



### **CAUTION**

- + Choose a location in which to place the equipment such that there is enough free space/clearance to the front, the rear and to the sides of the equipment.
- + The training room should be well ventilated during training and not be exposed to any draughts.
- + Choose the place in which to set up the equipment such that there is enough free space/clearance to the front, the rear and to the sides of the equipment.
- + The set-up and mounting surface of the equipment should be flat, loadable and solid.



### **ATTENTION**

- + The device may only be used in one building, in sufficiently tempered and dry rooms (ambient temperatures between 10°C and 35°C). The equipment should not be used outdoors or in rooms with high humidity (over 70%) like swimming pools.
- + A floor protective mat/equipment underlay can help to protect high-quality floor coverings (parquet, laminate, cork, carpets) from dents and sweat and can help to level out slight unevenness.

### 2.1 General Instructions

**⚠ DANGER**

- + Do not leave any tools, packaging materials such as foils or small parts lying around, as otherwise there is a danger of suffocation for children. Keep children away from the equipment during assembly.

**⚠ WARNING**

- + Pay attention to the instructions attached to the equipment in order to reduce the risk of injuries.

**⚠ CAUTION**

- + Ensure to have sufficient room for movement in each direction during assembly.
- + The assembly of the equipment must be carried out by at least two adults. If in doubt, seek the help of a third technically skilled person.

**▶ ATTENTION**

- + To prevent damage to the equipment and the floor, assemble the equipment on a mat or packaging board.

**ⓘ NOTICE**

- + In order to make the assembly as simple as possible, some screws and nuts to be used can already be pre-assembled.
- + Ideally, assemble the equipment at its later set-up place.

### 2.2 Scope of Delivery

The scope of delivery consist of the following parts. At the beginning, check whether all parts and tools belonging to the device are included in the scope of delivery and whether damage has occurred. In the event of complaints, the contractual partner must be contacted directly.

**⚠ CAUTION**

If parts of the scope of delivery are missing or damaged, the assembly must not be carried out.

**ⓘ NOTICE**

Batteries are not included in the scope of delivery. The following batteries are required: 1x AAA

Elliptical trainer x 1

Decoration cover x 1

**Tool kit**

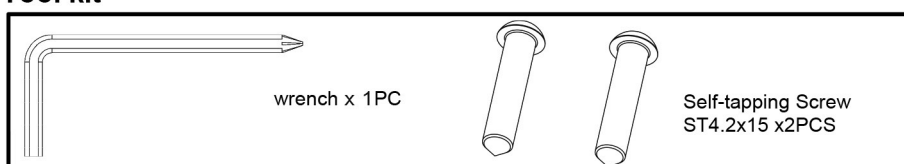

## 2.3 Assembly

Before assembly, take a close look at the individual assembly steps shown and carry out the assembly in the order given.

### ① NOTICE

- + First loosely screw all parts together and check that they fit properly. Tighten the screws using the tool only when you are instructed to do so.
- + If you have difficulty recognising the graphics, we recommend that you open and/or download the PDF instructions stored in the webshop on your end device (e.g. smartphone, tablet or PC). There you have the option of zooming in closer. Please note that the Adobe Acrobat Reader programme must be installed on your end device in order to open the file.

### Step 1: Assembly of the Covers

Assemble the cover (14) to the main frame (6) by using two screws (38).

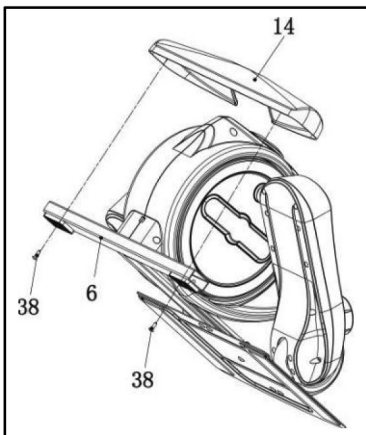

### Step 2: Adjusting of the Pedal Resistance

### ① NOTICE

There are 8 setting levels for the resistance.

Turn the resistance knob (25) clockwise to increase the resistance.

Turn the resistance knob (25) counterclockwise to reduce the resistance.

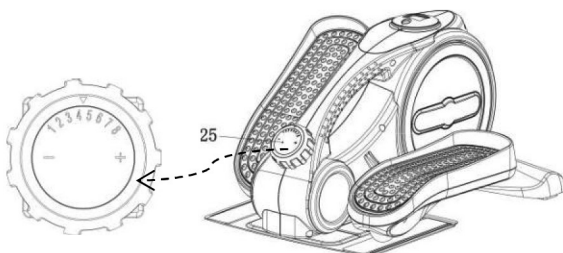

### Step 3: Insertion of the Battery into the LCD Display

**NOTICE**

The LCD display is powered by one AAA1.5V battery.

**ATTENTION**

Make sure not to damage the signal cable while pulling up the LCD display.

1. Slowly pull up the LCD display (24) from the top of the main frame (6).
2. Turn the LCD Display (24) to insert the battery into the battery compartment.

**NOTICE**

Make sure the battery is properly placed and springs contact correctly.

3. Attach the LCD Display (24) on the top of main frame (6).

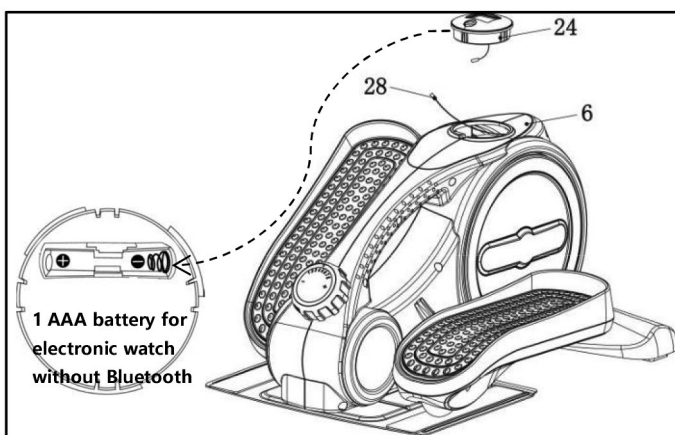

## 2.4 Battery Replacement

**NOTICE**

In case the console is not working properly or the LCD display is weak, the battery might be running low and needs to be replaced.

1. Open the battery compartment.
2. Remove the battery.
3. Insert a new AAA 1.5V battery.
4. Close the battery compartment.



## 3 OPERATING INSTRUCTIONS

### ① NOTICE

- + Familiarise yourself with all the functions and setting options of the device before starting training. Have the proper use of this product explained to you by a specialist.
- + Always start your training with low intensity and increase evenly and gently. End your training with a cool-down phase. If you are unsure, please consult your physician.

### 3.1 Console Display



<b>SCAN</b>	+ Display changes between TIME, CALORIE and REPS/MIN every 4 seconds
<b>TIME</b>	+ Display of workout time while exercising + Setting range: 00:00~99:59
<b>CALORIE</b>	+ Display of calories burned while exercising + Setting range: 0.0~9999 cal
<b>COUNT</b>	+ Display of steps while exercising + Setting range: 0-9999
<b>REPS/MIN</b>	+ Display of steps per minute while exercising + Setting range: 0-9999 spm (steps per minute)

## 3.2 Button Functions

	<ul style="list-style-type: none"><li>+ Press button shortly: the display will turn on/the final value will be displayed in sequence.</li><li>+ Press and hold the button for 4 seconds: all function values are reset to zero.</li></ul>
---	---

## 3.3 Start/Stop Training

1. When you start pedaling: the display automatically starts calculation of the values.
2. When you stop pedaling 4 seconds: calculation stops.
3. After you stop pedaling: the display will automatically turn off after 4 minutes.

► **ATTENTION**

Do not stand on the trainer! Only use it in a sitting position.

## 4 TROUBLESHOOTING, CARE AND MAINTENANCE

### 4.1 General Instructions

 **WARNING**

- + Do not make any improper changes to the equipment.

 **CAUTION**

- + Damaged or worn components may affect your safety and the life of the equipment. Therefore, immediately replace damaged or worn components. In such a case, contact the contract partner. The equipment must not be used until it has been repaired. If necessary, use only original spare parts.

► **ATTENTION**

- + In addition to the instructions and recommendations for maintenance and care given here, additional service and/or repair work may be necessary; this must only be carried out by authorised service technicians.

## 4.2 Faults and Fault Diagnosis

The equipment undergoes regular quality controls during production. Nevertheless, faults or malfunctions may occur. Frequently, individual parts are responsible for these disturbances, an exchange is usually sufficient. Please refer to the following overview for the most common errors and how to correct them. If the equipment still does not function properly, contact your contract partner.

Fault	Cause	Solution
Drive disks wobble/ make noises	Drive disk loose	Tighten nut (pay attention to left-hand / right-hand thread)
Display is blank/is not working	Loose cable connections	Check cable connections
Equipment wobbles	Equipment is not level	Align the feet
Creaking noises	Screw connections loosened or too tight	Check screw connections

## 4.3 Maintenance and Inspection Calendar

To avoid damage from body sweat, the equipment must be cleaned with a damp towel (no solvents!) after each training session.

The following routine tasks must be performed at the specified intervals:

Part	Weekly	Monthly	Quarterly
Display console	C	I	
Plastic covers	C	I	
Screws and cable connections		I	
Legend: C = clean; I = inspect			

## 5 DISPOSAL

At the end of its operational life, this equipment cannot be disposed of in normal household waste. Instead, it must be disposed of via an electricals recycling centre. Further information can be obtained from your local authority's recycling service.



The materials can be recycled as per their symbols. Through the reuse, recycling of materials or other forms of recovery of old equipment, you make an important contribution to the protection of the environment.





## 6.2 Parts List

No.	Name	Qty.	No.	Name	Qty.
1	Crank arm assembly (R)	1	22	shell (R)	1
2	Crank arm assembly (L)	1	23	Plastic plug	1
3	PU wheel	2	24	LCD Display	1
4	Magnet arm	1	25	Resistance Knob	1
5	Flying wheel set	1	26	Driving belt	1
6	Main frame	1	27	EVA Mat	2
7	Crank axle fixing plate	2	28	Square sensor	1
8	Pulley wheel set	1	29	Hex nut M5	2
9	Spindle for PU wheel	2	30	Hex nut M6	1
10	Bolt for Magnet arm	1	31	Hex nut M10x1.0	2
11	Spring	1	32	Hex socket screw M5x30	2
12	Washer	2	33	screw M6x10	6
13	Decorative cover	2	34	screw M6x40	1
14	Decorative cover	1	35	Bearing 61902ZZ	4
15	"Pedal cover right side upper"	1	36	Self-tapping screw ST4.2x20	35
16	"Pedal cover right side lower"	1	37	Self-tapping screw ST4.2x10	16
17	Pedal cover left side upper	1	38	Self-tapping screw ST4.2x15	2
18	Pedal cover left side lower	1	39	Flat washer 5.3 * 10.0 * T1	4
19	Cushion	2	40	C-clip 17.0xΦ15.7xT1	4
20	TPU cushion	2	41	C-clip 15.0xΦ13.8xT1	8
21	Shell (L)	1	42	wrench S5	1



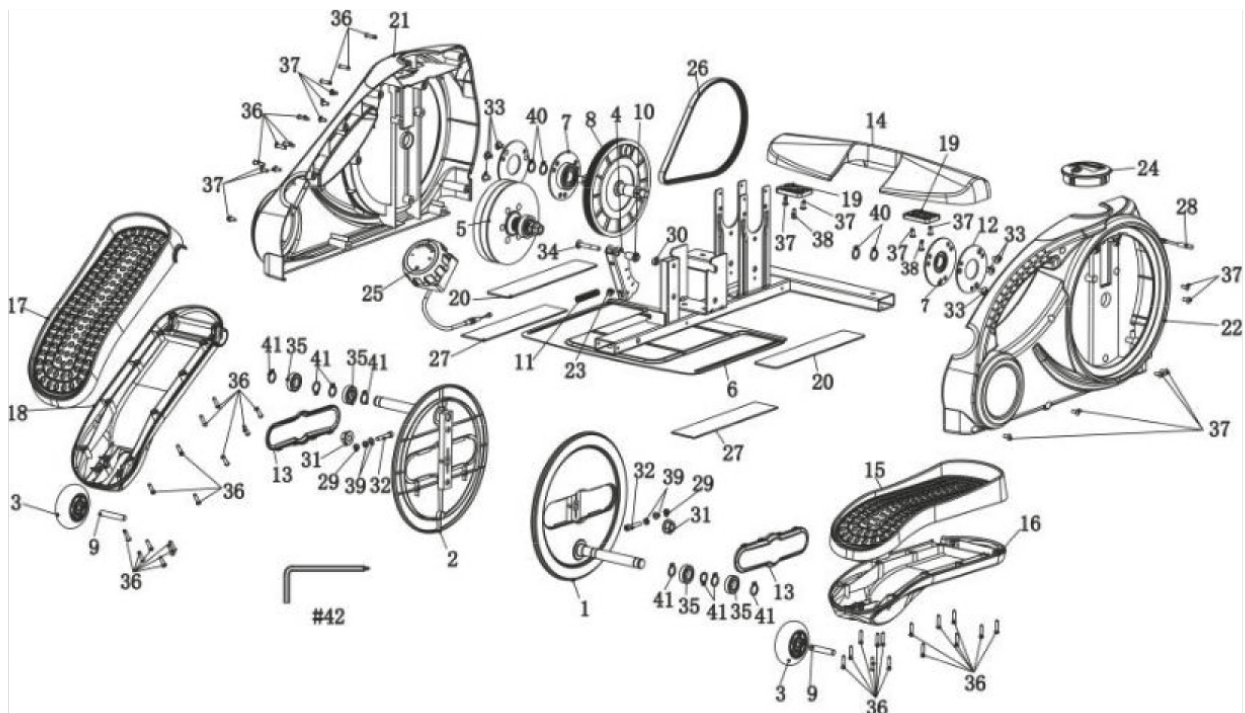



































## 6.3 Exploded Drawing



## 7 WARRANTY

### Warranty period

The warranty periods, shown on our web shop, begin on delivery of the fitness equipment. The respective warranty periods for your equipment can be found on its product website.

DE	DK	UK
<p><b>TECHNIK</b></p> <p> +49 4621 4210-900   +49 4621 4210-698   technik@fitshop.de   Öffnungszeiten entnehmen Sie unserer Homepage.</p> <p><b>SERVICE</b></p> <p> 0800 20 20277 (kostenlos)   04621 4210 - 0   info@fitshop.de   Öffnungszeiten entnehmen Sie unserer Homepage:  <a href="https://stg.fit/statita">https://stg.fit/statita</a></p>	<p><b>TEKNIK OG SERVICE</b></p> <p> 80 90 16 50  +49 4621 4210-945   info@fitshop.dk   Åbningstider kan findes på hjemmesiden:  <a href="https://stg.fit/statit7">https://stg.fit/statit7</a></p>	<p><b>CUSTOMER SUPPORT</b></p> <p> 00800 2020 2772  +494621 4210 944   info@fitshop.co.uk   You can find the opening hours on our homepage:  <a href="https://stg.fit/statitc">https://stg.fit/statitc</a></p>
	FR	BE
	<p><b>TECHNIQUE &amp; SERVICE</b></p> <p> +33 (0) 189 530984  +49 4621 42 10 933   info@fitshop.fr   Vous trouverez les heures d'ouverture sur notre site Internet:  <a href="https://stg.fit/statit4">https://stg.fit/statit4</a></p>	<p><b>TECHNIQUE &amp; SERVICE</b></p> <p> 02 732 46 77  +49 4621 4210 933   info@fitshop.be   Vous trouverez les heures d'ouverture sur notre site Internet:  <a href="https://stg.fit/statit8">https://stg.fit/statit8</a></p>
ES	NL	INT
<p><b>TECNOLOGÍA Y SERVICIOS</b></p> <p> 911 238 029   info@fitshop.es   Consulta nuestro horario de apertura en la página web:  <a href="https://stg.fit/statit5">https://stg.fit/statit5</a></p>	<p><b>TECHNISCHE DIENST &amp; SERVICE</b></p> <p> +31 172 619961   service@fitshop.nl   De openingstijden vindt u op onze homepage:  <a href="https://stg.fit/statit3">https://stg.fit/statit3</a></p>	<p><b>TECHNICAL SUPPORT &amp; SERVICE</b></p> <p> +49 4621 4210-944   service-int@fitshop.de   You can find the opening hours on our homepage:  <a href="https://stg.fit/statita">https://stg.fit/statita</a></p>
PL	AT	CH
<p><b>DZIAŁ TECHNICZNY I SERWIS</b></p> <p> 22 307 43 21  +49 4621 42 10-948   info@fitshop.pl   Godziny otwarcia można znaleźć na stronie głównej:  <a href="https://stg.fit/statit6">https://stg.fit/statit6</a></p>	<p><b>TECHNIK &amp; SERVICE</b></p> <p> 0800 20 20277 (Freecall)  +49 4621 42 10-0   info@fitshop.at   Öffnungszeiten entnehmen Sie unserer Homepage:  <a href="https://stg.fit/statitb">https://stg.fit/statitb</a></p>	<p><b>TECHNIK &amp; SERVICE</b></p> <p> 0800 202 027  +49 4621 42 10-0   info@fitshop.ch   Öffnungszeiten entnehmen Sie unserer Homepage:  <a href="https://stg.fit/statit9">https://stg.fit/statit9</a></p>

Please find a detailed overview including address and opening hours for all stores of the Fitshop Group in Germany and abroad on the following website:

[www.fitshop.com/en/stores](http://www.fitshop.com/en/stores)

# WE LIVE FITNESS

## WEBSHOP AND SOCIAL MEDIA

Fitshop is Europe's largest specialist store for home fitness equipment with currently over 70 stores and one of the world's most renowned online mail order companies for fitness equipment. Private customers order via the 25 web shops in the respective national language or have their desired equipment assembled on site. In addition, the company supplies fitness studios, hotels, sports clubs, companies and physio practices with professional equipment for endurance and strength training.

Fitshop offers a wide range of fitness equipment from renowned manufacturers, high-quality in-house developments and comprehensive services, such as a build-up service and sports scientific advice before and after the purchase. The company employs numerous sports scientists, fitness trainers and competitive athletes.

Visit us also on our social media platforms or our blog!

	<a href="http://www.fitshop.co.uk">www.fitshop.co.uk</a> <a href="http://www.fitshop.de/blog">www.fitshop.de/blog</a>
---	--

	<a href="http://www.facebook.com/fitshopgroup">www.facebook.com/fitshopgroup</a>
---	--

	<a href="http://www.instagram.com/fitshopgroup/">www.instagram.com/fitshopgroup/</a>
---	--

	<a href="http://www.youtube.com/@fitshop_uk">www.youtube.com/@fitshop_uk</a>
--	--

**KETTLER**

**TAURUS**

 cardiostrong

*BODYCRAFT*

 cardiojump

 **DUKEFITNESS**

**DARWIN**

Notes





**Mini Elliptical Trainer**