



Assembly and Operating Instructions



max. 120 kg



~ 30 Min.



32 kg

L 210 | B 56 | H 53

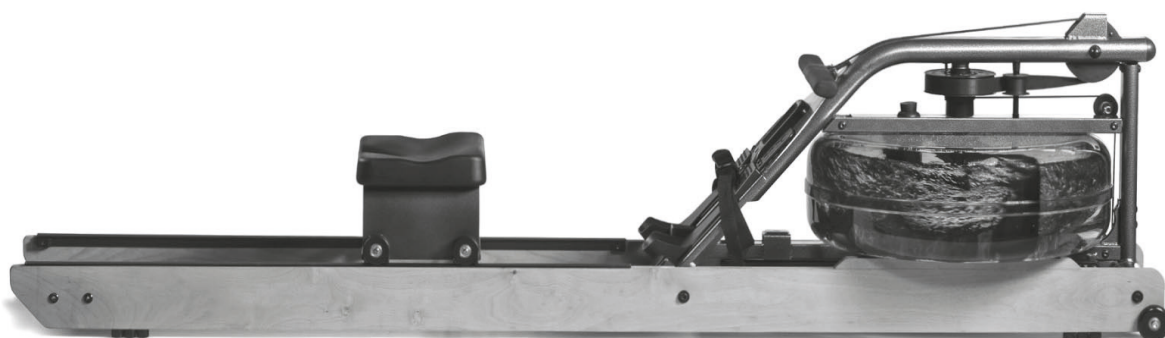

CSTNAT.01.01

Art. No. CST-NAT

NATURAL ROWER

Content

1	GENERAL INFORMATION	7
1.1	Technical Data	7
1.2	Personal Safety	8
1.3	Set-Up Place	9
2	ASSEMBLY	10
2.1	General Instructions	10
2.2	Scope of Delivery	11
2.3	Assembly	12
2.3.1	Filling and Emptying of the Tank	14
2.4	Replacement of Batteries	15
3	OPERATING INSTRUCTIONS	16
3.1	Console Display	16
3.2	Button Functions	17
3.3	First Use	18
3.4	Programmes	19
3.4.1	Target Programme: Distance Workouts	19
3.4.2	Target Programme: Time Workouts	19
4	STORAGE AND TRANSPORT	20
4.1	General Instructions	20
4.2	Transportation Wheels	20
5	TROUBLESHOOTING, CARE AND MAINTENANCE	21
5.1	General Instructions	21
5.2	Faults and Fault Diagnosis	21
6	DISPOSAL	22
5.3	Error Codes and Troubleshooting	22
5.4	Maintenance and Inspection Calendar	22
7	RECOMMENDED ACCESSORIES	23
8	ORDERING SPARE PARTS	24
8.1	Serial Number and Model Name	24
9	WARRANTY	25
10	CONTACT WATERROWER	27

Dear customer,

thank you for choosing fitness equipment from cardiostrong®. Cardiostrong offers high-quality home fitness equipment that is optimally adapted to the conditions at home. Train at home no matter what the weather or time of the day. cardiostrong fitness equipment offers training programmes and a variety of equipment for all training levels and all training goals. Further information can be found at www.sport-tiedje.com or www.cardiostrong.de. We hope you enjoy your training!

Further information can be found at www.sport-tiedje.com.

Intended Use

The equipment may only be used for its intended purpose.

The equipment is only suitable for home use. The equipment is not suitable for semi-professional (e.g. hospitals, associations, hotels, schools, etc.) and commercial or professional use (e.g. fitness studios).

Legal Notice

Sport-Tiedje GmbH
Europe's No. 1 for home fitness

International Headquarters
Flensburger Straße 55
24837 Schleswig
Germany

Management:
Christian Grau
Sebastian Campmann
Dr. Bernhard Schenkel
No. HRB 1000 SL
Local Court Flensburg
European VAT Number: DE813211547

Disclaimer



©2011 cardiostrong® is a registered brand of the company SportTiedje GmbH. All rights reserved. Any use of this trademark without the explicit written permission of Sport-Tiedje is prohibited.

Product and manual are subject to change. Technical data can be changed without advance notice.

ABOUT THIS MANUAL

Please carefully read the entire manual before installation and first use. The manual will help you to quickly set up the system and explains how to safely use it. Make sure that all persons exercising with the equipment (especially children and persons with physical, sensory, mental or motor disabilities) are informed about this manual and its contents in advance. In case of doubt, responsible persons must supervise the use of the equipment.



This equipment has been manufactured according to the latest safety knowledge. As far as possible, potential safety hazards which could cause injury have been eliminated. Make sure to carefully follow the instructions and that all parts are securely in place. If required, read through the instructions again to correct any mistakes.

Please pay close attention to the safety and maintenance instructions given here. The contract partner cannot be held liable for damage to health, accidents or damage to the equipment when it is not used in accordance with these instructions.

The following safety instructions may appear in this manual:

► **ATTENTION**

This notice indicates potentially hazardous situations which, if not avoided, may result in property damage.

⚠ **CAUTION**

This notice indicates potentially hazardous situations which, if not avoided, may result in slight or minor injuries!

⚠ **WARNING**

This notice indicates potentially hazardous situations which, if not avoided, may result in death or serious injuries!

⚠ **DANGER**

This notice indicates potentially hazardous situations which, if not avoided, will result in death or serious injuries!

ⓘ **NOTICE**

This notice indicates further useful information.

Retain these instructions in a safe place for future reference, maintenance or when ordering replacement parts.

1.1 Technical Data

LCD - Display of:

- + Strokes
- + Training time
- + Distance
- + Intensity

Resistance system:

Water resistance

Training programs in total:

2

Target programs:

2

Weight and dimensions:

Article weight (gross, incl. packaging):

Box 1/2 approx. 26 kg
Box 2/2 approx. 9,5 kg

Article weight (net, without packaging):

32 kg

Packaging dimensions (L x W x H):

Box1/2 approx. 220 cm x 16 cm x 7,5 cm
Box2/2 approx. 93 cm x 58 cm x 49,5 cm

Set-up dimensions (L x W x H):

approx. 210 cm x 56 cm 53 cm

Folding dimensions (L x B x H):

approx. 53 cm x 56 cm x 210 cm

Maximum user weight:

120 kg

1.2 Personal Safety

DANGER

- + Before you start using the equipment, you should consult your physician that this type of exercise is suitable for you from a health perspective. Particularly affected are persons who: have a hereditary disposition to high blood pressure or heart disease, are over the age of 45, smoke, have high cholesterol values, are overweight and/or have not exercised regularly in the past year. If you are under medical treatment that affects your heart rate, medical advice is absolutely essential.
- + Note that excessive training can seriously endanger your health. Please also note that heart rate monitoring systems can be inaccurate. If you notice any signs of weakness, nausea, dizziness, pain, shortness of breath, or other abnormal symptoms, stop exercising immediately and seek advice from your doctor if necessary.

WARNING

- + This equipment may not be used by children under the age of 14.
- + Children should not be allowed unsupervised access to the equipment.
- + Persons with disabilities must have a medical license and must be under strict observation when using the equipment.
- + The equipment is strictly for use by one person at a time.
- + If your equipment provides a safety key, the clip of the safety key must be attached to your clothing before starting your training. In the event of a fall, the EMERGENCY STOP of the equipment can be initiated.
- + Keep your hands, feet and other body parts, hair, clothing, jewellery and other objects well clear of moving parts.
- + During use, wear suitable sports clothing rather than loose or baggy clothing. When wearing sports shoes, make sure they have suitable soles, preferably made of rubber or other non-slip materials. Shoes with heels, leather soles, studs or spikes are unsuitable. Never exercise barefoot.

CAUTION

- + If your equipment needs to be connected to the power supply with a mains cable, make sure that the cable is not a potential tripping hazard.
- + Make sure that nobody is within the range of motion of the equipment during training so as not to endanger you or other persons.

ATTENTION

- + Do not insert any objects of any kind into the openings of the device.

1.3 Set-Up Place



WARNING

- + Do not place the equipment in main corridors or escape routes.



CAUTION

- + Choose a location in which to place the equipment such that there is enough free space/clearance to the front, the rear and to the sides of the equipment. Make sure that you leave at least 30 cm on each side of the equipment and at least 15 cm in front of and behind the equipment as a training zone. This is the minimum required area in order to safely use the equipment. The recommended free zone around the equipment should be at least 60 cm on each side and 45 cm in front of and behind the equipment.
- + The training room should be well ventilated during training and not be exposed to any draughts.
- + Choose the place in which to set up the equipment such that there is enough free space/clearance to the front, the rear and to the sides of the equipment.
- + The set-up and mounting surface of the equipment should be flat, loadable and solid.

ATTENTION

- + The device may only be used in one building, in sufficiently tempered and dry rooms (ambient temperatures between 10°C and 35°C). The equipment should not be used outdoors or in rooms with high humidity (over 70%) like swimming pools.
- + A floor protective mat/equipment underlay can help to protect high-quality floor coverings (parquet, laminate, cork, carpets) from dents and sweat and can help to level out slight unevenness.

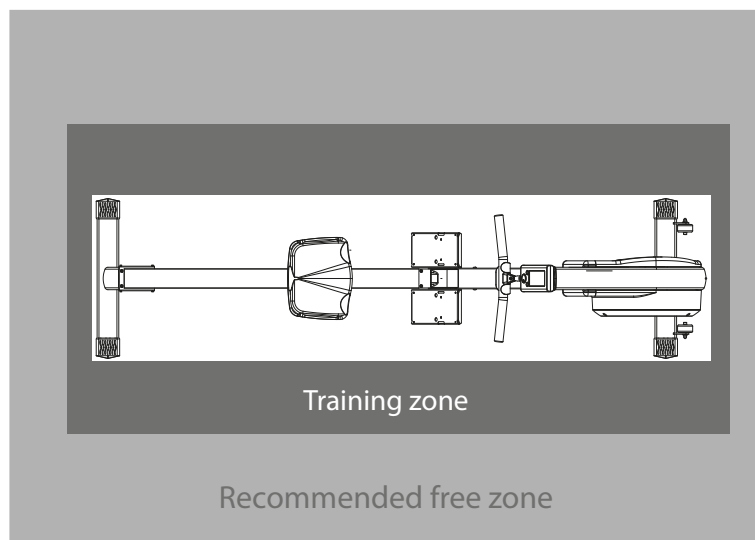

2.1 General Instructions



DANGER

- + Do not leave any tools, packaging materials such as foils or small parts lying around, as otherwise there is a danger of suffocation for children. Keep children away from the equipment during assembly.



WARNING

- + Pay attention to the instructions attached to the equipment in order to reduce the risk of injuries.



CAUTION

- + Ensure to have sufficient room for movement in each direction during assembly.
- + The assembly of the equipment must be carried out by at least two adults. If in doubt, seek the help of a third technically skilled person.



ATTENTION

- + To prevent damage to the equipment and the floor, assemble the equipment on a mat or packaging board.



NOTICE



- + In order to make the assembly as simple as possible, some screws and nuts to be used can already be pre-assembled.
- + Ideally, assemble the equipment at its later set-up place.

2.2 Scope of Delivery

The scope of delivery consist of the following parts. At the beginning, check whether all parts and tools belonging to the device are included in the scope of delivery and whether damage has occurred. In the event of complaints, the contractual partner must be contacted directly.

 **CAUTION**

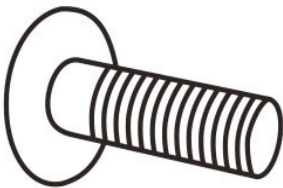
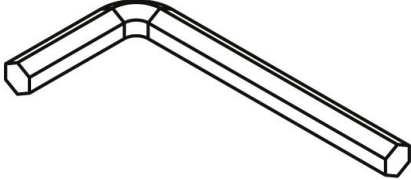
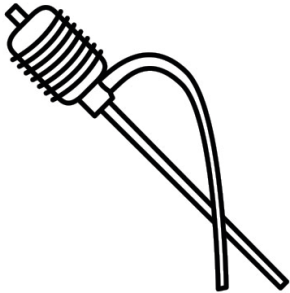
If parts of the scope of delivery are missing or damaged, the assembly must not be carried out.

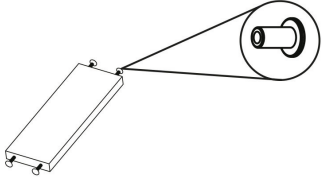
A. Screw (x4)	
B. 5mm Allen key	
C. Water pump	
D. Chlorine tablets	
E. Distance piece (x1) with pre-assembled screws (x4)	

2.3 Assembly

Before assembly, take a close look at the individual assembly steps shown and carry out the assembly in the order given.

① NOTICE

First loosely screw all parts together and check that they fit properly. Then tighten the screws using the tool only when you are instructed to do so.

Step 1: Assembly of the tank module

1. Remove the accessories, seat, tank module, rear distance piece and rails from the packaging.
2. Attach the tank module to the wooden rails by loosely tightening the four screws with the Allen key.
3. If necessary, loosen the four front screws and the screws at the bottom of the foot rest to align the rails.
4. Retighten the screws.

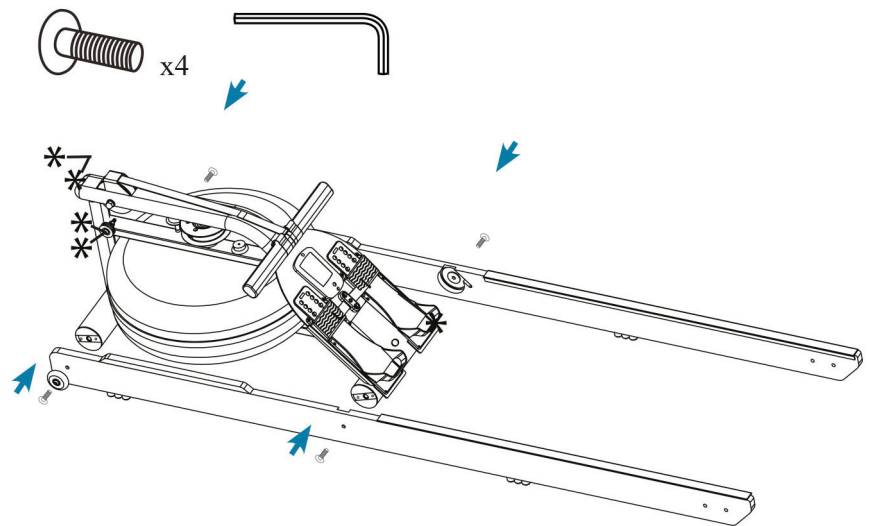

Step 2: Assembly of the seat onto the rails

1. Place the seat on the rails so that the notch points towards the rear of the rowing machine.
2. Make sure that the guide wheels (the smaller wheels on the bottom of the seat) are located under the lip seal on the rails.

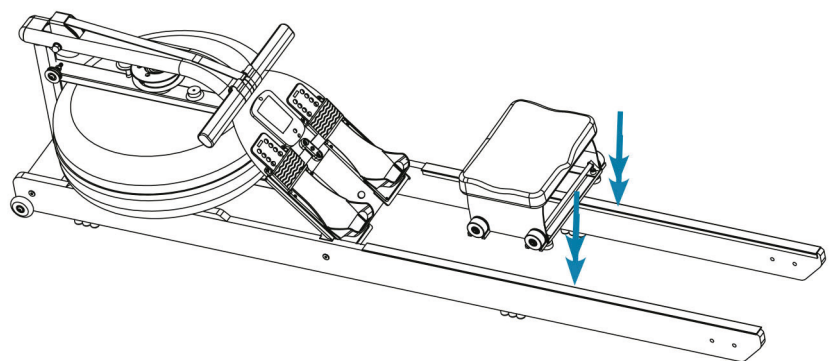

Step 3: Removing of the screws from the distance piece

Remove the four pre-assembled screws from the distance piece.

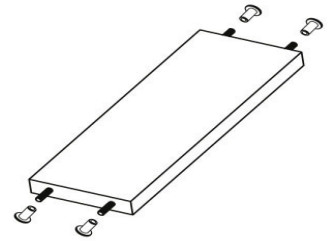

Step 4: Inserting of the distance piece

1. Place the distance piece between the rails.
2. If necessary, pull the rails slightly apart to fit the distance piece into the pre-drilled holes.

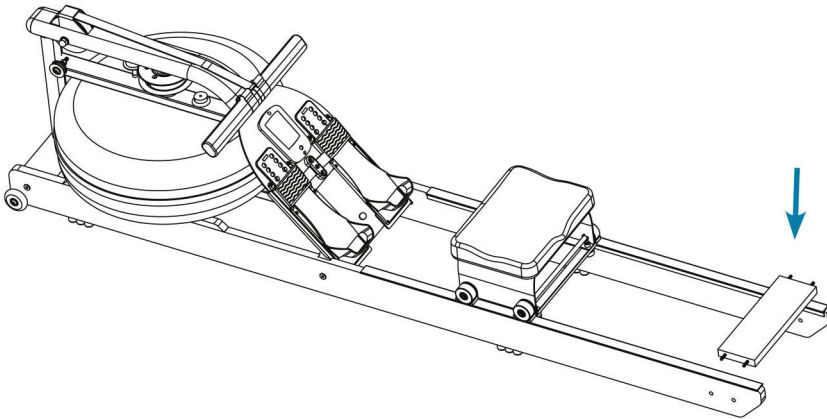

Step 5: Assembly of the distance piece

Attach the distance piece to the wooden rails with the Allen key, using the 4 pre-assembled screws previously removed in step 3.

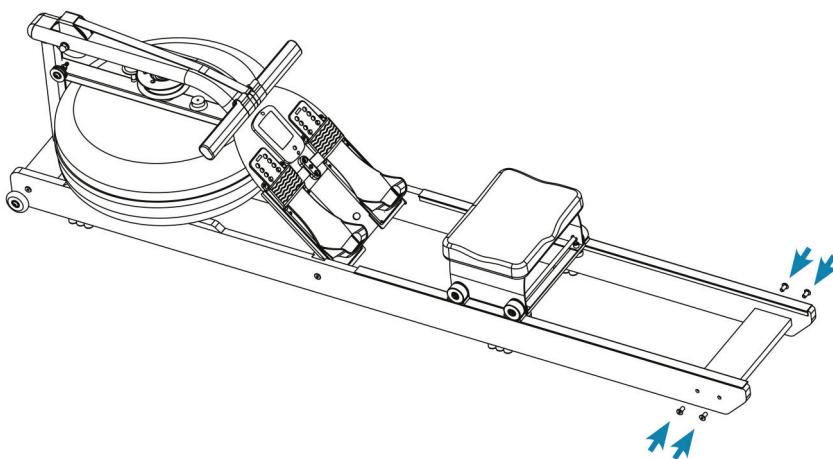

Schritt 6: Tightening of the screws

Tighten all screws.

2.3.1 Filling and Emptying of the Tank

⚠ CAUTION

- + The water inside the tank must not be drunk and must be disposed of after use.

▶ ATTENTION

- + Fill the tank only with tap water. Do not use distilled water.
- + Do not fill the water tank above the maximum capacity, this may void the warranty. The maximum filling quantity can be found in the section on the water level in this chapter.
- + To prevent algae formation, limescale and possible damage to the tank, we recommend the use of chlorine tablets. Only use chlorine tablets for rowing machines.

ⓘ NOTICE

- + Add a new chlorine tablet approximately every 6 months.

1. Remove the tank plug.

▶ ATTENTION

- + Make sure not to fill the tank beyond the maximum level of "19" indicated on the level indicator sticker (level indicator sticker is located on the side of the tank just below the seam).
- + Overfilling the tank may lead to leakage or damage to the components and thus lead to expiry of the product warranty. Fill with water using the pump provided.

2. Fill in water with the supplied pump.
3. Add a chlorine tablet.
4. Insert the tank plug.

Water level

Recommended water level markings are between level mark "16" and "18" for a standard amount of water.

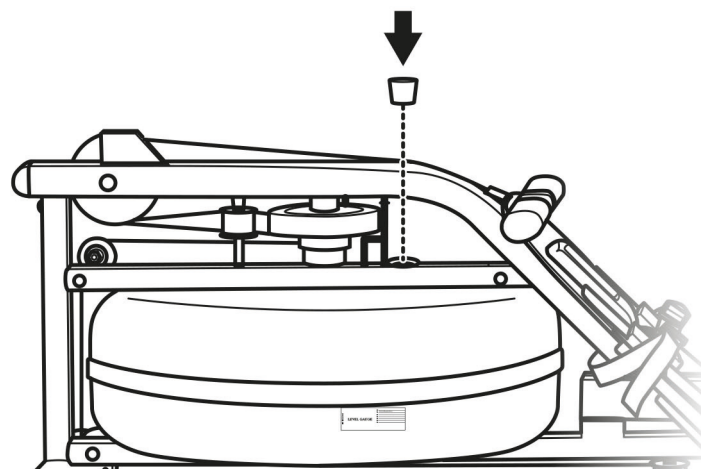
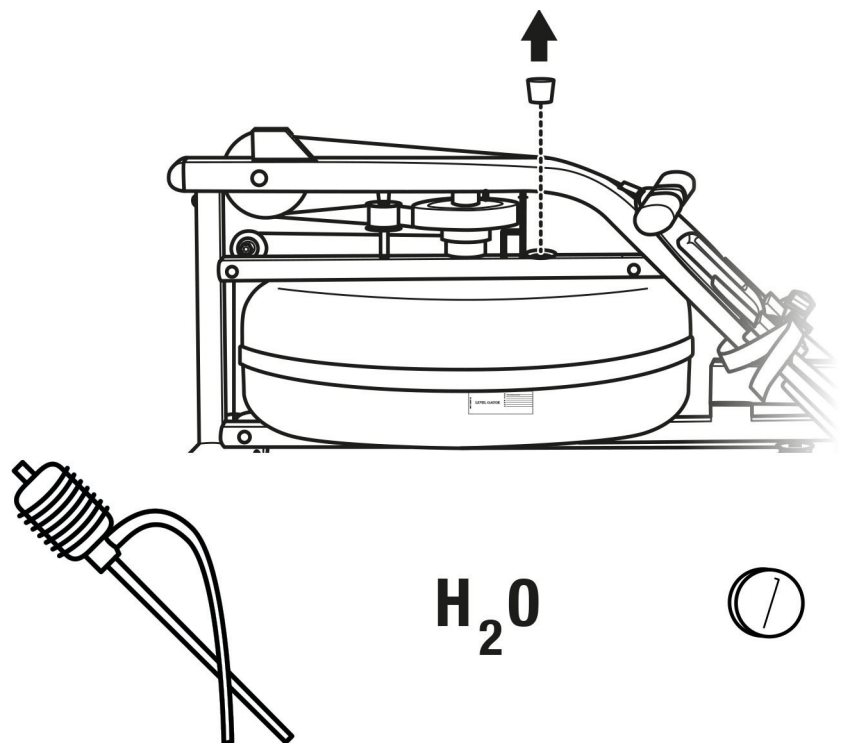

2.4 Replacement of Batteries

1. Use an Allen key to remove the screws at the top and bottom of the console.
2. Carefully lift the console off the foot rest.
3. Remove the battery unit that is located in the recess of the foot rest.
4. Remove the 2 AA batteries and replace them with 2 new ones.

► **ATTENTION**

In the following step, make sure that no cables are stuck under the edges of the console.

5. Place the console on the foot rest.
6. Insert both screws and tighten them.

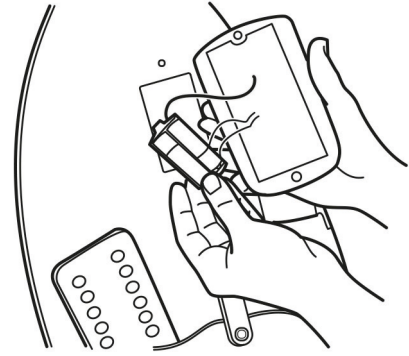

3 OPERATING INSTRUCTIONS

① NOTICE

Familiarise yourself with all the functions and setting options of the device before starting training. Have the proper use of this product explained to you by a specialist.

3.1 Console Display

① NOTICE

The console is designed to balance function and ease of use. The console display consists of 4 information windows, 2 selection buttons and 3 navigation buttons.

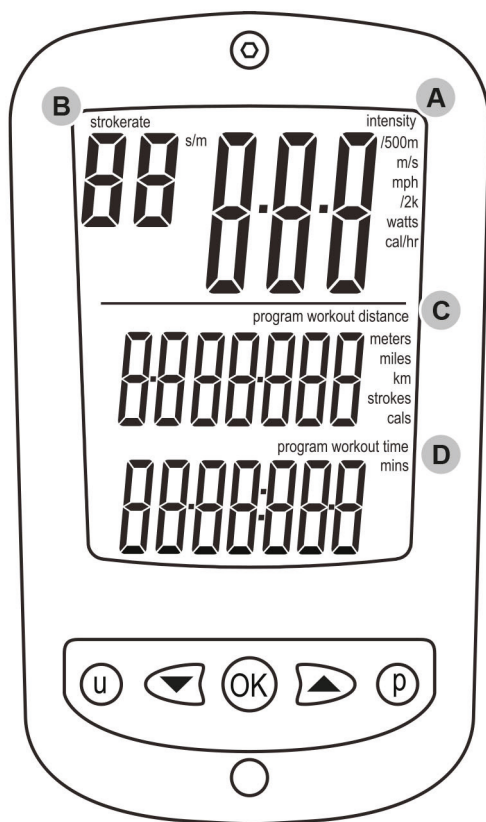

A: Intensity	+ Displays the intensity of the exercise in different units (minutes per 500 metres, metres per second, miles per hour and minutes per 2 kilometres, watts, calories burned per hour)
B: Stroke number	+ Displays the number of strokes per minute
C: Distance	+ Displays the covered distance in different units (metres, miles, kilometres and strokes or calories burned)
D: Time	+ Displays the duration of the exercise in units of hours, minutes and seconds

3.2 Button Functions

<p>u</p>	<ul style="list-style-type: none"> + Press the u button once to change the intensity units. + Press this button twice to change the distance units. + Intensity units: Press the u button until the intensity units are displayed. + Distance units: Press the u button until the distance units are displayed.
<p>OK</p>	<ul style="list-style-type: none"> + Press the OK button to switch on the console. + Intensity units: Press OK in the unit display to confirm the desired unit. + Distance units: Press OK in the unit display to confirm the desired unit. + Distance workout: press OK once the desired training distance has been set. + Time workout: press OK once the desired training time has been set.
<p>p</p>	<ul style="list-style-type: none"> + Press the p button once to set distance workouts. + Press the p button twice to set time workouts.
<p>Arrow buttons</p>	<ul style="list-style-type: none"> + Intensity units: Press the arrow buttons in the unit display to select the desired unit: /500m, m/s, mph, /2km, watts or cal/hr + Distance units: Press the arrow buttons in the unit display to select the desired unit: meters, miles, km, strokes or calories. + Distance workout: Press the “up” arrow key to increase the training distance by 50 meters. + Distance workout: Press the “down” arrow button to decrease the workout distance by 10 meters. + Distance workout: Press and hold any of the arrow buttons to scroll faster. + Time Workout: Press the “up” arrow button to increase the workout time by 1 minute. + Time Workout: Press the “down” arrow button to decrease the workout time by 10 seconds. + Time Workout: Press and hold any of the arrow buttons to speed up scrolling.

3.3 First Use

To switch on the console, press the OK button.

The four information windows show zeros and the console is in standby mode.

ⓘ NOTICE

The console switches off automatically after 2 minutes of inactivity.

As soon as you start rowing, the information is displayed.

3.4 Programmes

The following programmes are available:

- + Distance
- + Time

3.4.1 Target Programme: Distance Workouts

1. Press the p button once until the "Program Workout Distance" programme is displayed with the distance units.
2. To display the distance units, press the u button.
3. To select the desired unit, use the arrow buttons: metres, miles, km, strokes, or calories.
4. When the desired unit flashes, press OK.
5. To increase the training distance by 50 metres, press the "up" arrow button.
6. To decrease the training distance by 10 metres, press the "down" arrow button.
7. To scroll faster, press and hold one of the arrow buttons.
8. As soon as the desired training distance is set, press OK.

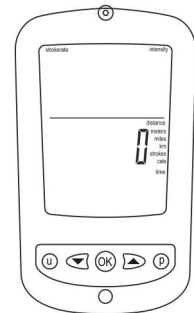

The console returns to standby mode at the set distance.

Once you start rowing, the distance is counted down.

3.4.2 Target Programme: Time Workouts

1. Press the p button twice until the "Program Workout Time" programme is displayed with the time units.
2. To display the intensity units, press the u button.
3. To select the desired unit, use the arrow buttons: /500m, m/s, mph, /2km, watts or cal/hr.
4. When the desired unit flashes, press OK.
5. To increase the workout time by 1 minute, press the "up" arrow button.
6. To decrease the workout time by 10 seconds, press the "down" arrow button.
7. To scroll faster, press and hold one of the arrow buttons.
8. As soon as the desired training distance is set, press OK.

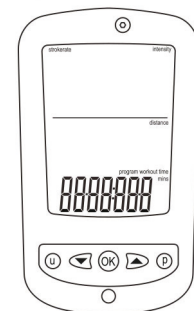

The console returns to standby mode at the set time.

Once you start rowing, the time is counted down.

4.1 General Instructions

WARNING

- + The storage location should be chosen so that improper use by third parties or children can be prevented.
- + If your equipment does not have transportation wheels, the equipment must be disassembled before transportation.

▶ ATTENTION

- + Make sure that the equipment is protected from moisture, dust and dirt in the selected storage location. The storage location should be dry and well ventilated and have a constant ambient temperature between 10°C and 35°C.

4.2 Transportation Wheels

▶ ATTENTION

If you want to transport your equipment over particularly sensitive and soft floor coverings, such as parquet, planks or laminate, lay out the transport route with cardboard or similar to avoid possible floor damage.

1. Stand in front of the equipment and lift it until the weight is transferred to the transportation wheels. After that, you easily can move the equipment to a new position. For long transport distances the equipment should be disassembled and safely packed.
2. Select the new location by following the instructions in the section 1.33 of this manual.

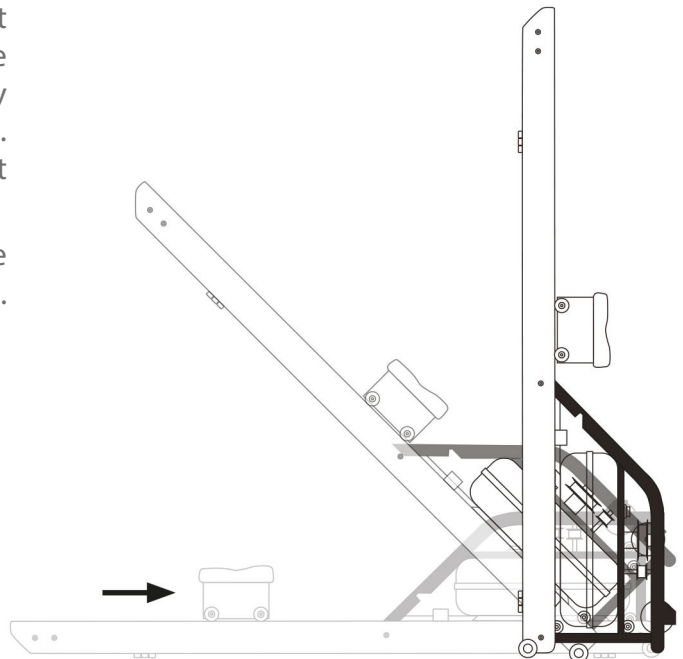

5.1 General Instructions



WARNING

- + Do not make any improper changes to the equipment.



CAUTION

- + Damaged or worn components may affect your safety and the life of the equipment. Therefore, immediately replace damaged or worn components. In such a case, contact the contract partner. The equipment must not be used until it has been repaired. If necessary, use only original spare parts.

ATTENTION

- + In addition to the instructions and recommendations for maintenance and care given here, additional service and/or repair work may be necessary; this must only be carried out by authorised service technicians.

5.2 Faults and Fault Diagnosis

The equipment undergoes regular quality controls during production. Nevertheless, faults or malfunctions may occur. Frequently, individual parts are responsible for these disturbances, an exchange is usually sufficient. Please refer to the following overview for the most common errors and how to correct them. If the equipment still does not function properly, contact your contract partner.

Fault	Cause	Solution
Display is blank/is not working	Batteries empty or loose cable connection	Replace batteries or check cable connections
Creaking noises	Screw connections loosened or too tight	Check screw connections
Grinding noises on the guide rail	Guide rail or rollers dirty or guide rail dry	Clean the guide rail and then lubricate it with a suitable lubricant
No pulse display	<ul style="list-style-type: none"> + Sources of interference in the room + unsuitable chest strap + Wrong position of chest strap + Chest strap defective or battery empty + Pulse display defective 	<ul style="list-style-type: none"> + Eliminate sources of interference (e.g. mobile phone, WLAN, lawn mower and vacuum cleaner robot, etc. ...) + Use a suitable chest strap (see RECOMMENDED ACCESSORIES). + Reposition chest strap and/or moisten electrodes + Changing batteries

5.3 Error Codes and Troubleshooting

The electronics of the equipment continuously carries out tests. In case of deviations, an error code appears on the display and normal operation is stopped for your safety.

Please contact Sport-Tiedje for technical support.

5.4 Maintenance and Inspection Calendar

To avoid damage from body sweat, the equipment must be cleaned with a damp towel (no solvents!) after each training session.

The following routine tasks must be performed at the specified intervals:

Part	Weekly	Monthly	Quarterly	Half-yearly
Display console	C	I		
Lubrication of slide rail and moving parts		I		
Plastic covers	C	I		
Screws and cable connections		I		
Water colour/Chlorine				I
Legend: C = clean; I = inspect				

6 DISPOSAL

At the end of its operational life, this equipment cannot be disposed of in normal household waste. Instead, it must be disposed of via an electricals recycling centre. Further information can be obtained from your local authority’s recycling service.



The materials can be recycled as per their symbols. Through the reuse, recycling of materials or other forms of recovery of old equipment, you make an important contribution to the protection of the environment.

7 RECOMMENDED ACCESSORIES

To make your training experience even more efficient and pleasant, we recommend that you add suiting accessories to your fitness equipment. This could be a floor mat, for example, which makes your fitness equipment stand more securely and also protects the floor from falling sweat, but it could also be additional handrails on some treadmills or silicone spray to keep moving parts in good shape.

If you have purchased a fitness machine with pulse training and want to train your heart rate, we strongly recommend that you use a compatible chest strap, as this ensures optimum transmission of the heart rate. You may want to buy additional grips or weights for multi gyms.



Our range of accessories offers the highest quality and makes training even better. If you would like to find out more about compatible accessories, please go to the detail page of the product in our webshop (the easiest way is to enter the article number in the search field above) and go to the recommended accessories on this page. Alternatively, you can use the QR code provided. Of course, you can also contact our customer service: by telephone, e-mail, in one of our branches or via our social media channels. We will be happy to advise you!



floor mat



chest strap



chest strap contact gel



towels



silicone spray

8.1 Serial Number and Model Name

In order to provide you with the best possible service, please have the model name, article number, serial number, exploded drawing and parts list ready. The corresponding contact options can be found in chapter 10 of this operating manual.

NOTICE

The serial number of your equipment is unique. It's located on a white sticker.

Enter the serial number in the appropriate field.

Serial number:

Brand / Category:

Model Name:

Article Number:

Training equipment from cardiostrong® is subject to strict quality control. However, if a fitness equipment purchased from us does not work perfectly, we take it very seriously and ask you to contact our customer service as indicated. We are happy to help you by phone via our service hotline.

Error Descriptions

Your fitness equipment is developed for long-term, high-quality training. However, should a problem arise, please first read the operating instructions. For further assistance, please contact your contract partner or call our service hotline. To ensure your problem is solved as quickly as possible, please describe the defect as exactly as possible.

In addition to the statutory warranty, we provide a warranty for every fitness equipment purchased from us according to the following provisions.

Your statutory rights are not affected.

Warrantee

The warrantee is the first/original buyer and/or any person who received a newly purchased product as a gift from the original buyer.

Warranty period

The warranty periods, shown on our web shop, begin on delivery of the fitness equipment. The respective warranty periods for your equipment can be found on its product website.

Repair Costs

According to our choice, there will either be a repair, a replacement of individual damaged parts or a complete replacement. Spare parts, that have to be mounted while assembling the equipment, have to be replaced by the warrantee personally and are not a part of repair. After the expiration of the warranty period for repair costs, a pure parts warranty applies, which does not include the repair, installation and delivery costs.

The terms of use are defined as follows:

- + Home use: solely for private use in private households up to 3 hours per day
- + Semi-professional use: up to 6 hours per day (e. g. rehabilitation centres, hotels, clubs, company gyms)
- + Professional use: more than 6 hours per day (e. g. commercial gyms)

Warranty Service

Within the warranty period, equipment which develops faults as a result of material or manufacturing defects, will be repaired or replaced at our discretion. Ownership of equipment or parts of equipment which have been replaced is transferred to us. The warranty period is not extended nor does a new warranty period begin following repair or replacement under the warranty.

Warranty Conditions

For the warranty to be valid, the following steps must be taken:

Please contact our customer service by email or phone. If the product under warranty has to be sent in for repair, the seller bears costs. After expiry of the warranty, the buyer bears the costs of transport and insurance. If the fault is covered by our warranty, you will receive a new or repaired equipment in return.

Warranty claims are invalid in case of damage resulting from:

- + misuse or improper handling
- + environmental influences (moisture, heat, electrical surge, dust, etc.)
- + failure to follow the current safety measures for the equipment
- + failure to follow the operating instructions
- + use of force (e. g. hitting, kicking, falling)
- + interventions which were not carried out by one of our authorized service centres
- + unauthorised repair attempts

Proof of Purchase and Serial Number

Please make sure that you are able to provide the appropriate receipt when claiming on your warranty. So that we can clearly identify the model of your equipment, and for the purposes of our quality control, you will need to give the serial number of your equipment, when contacting the service team. Where possible please have your serial number and your customer number ready when you call our service hotline. It will help us to deal with your request swiftly.































If you cannot find the serial number on your fitness equipment, our service team is at your disposal to offer further information.

Service outside of the Warranty Period

We are also happy to issue an individual cost estimate if there is a problem with your fitness equipment after the warranty has expired, or in cases which do not fall under the terms of the warranty, e. g. normal wear and tear. Please contact our customer service team to find a quick and cost-effective solution to your problem. In such a case you will be responsible for the delivery costs.

Communication

Many problems can be solved just by speaking to us as your specialist supplier. We know how important it is to you as a user of the fitness equipment to have problems solved quickly and simply, so you can enjoy working out with minimal interruption. For that reason, we also want to resolve your queries quickly and in a straightforward manner. Thus, please always keep your customer number and the serial number of the faulty equipment handy.

DE		DE		DE	
WATERROWER GMBH  +49 59 21 - 17 98 400  +49 59 21 - 17 98 411  info@waterrower.de  Otto-Hahn-Straße 75, 48529 Nordhorn  Mon - Fri 08:00 - 17:00		VERTRIEBSBÜRO SÜD  +49 89 - 2000 666 55  info@nohrd.de  Karlstraße 29, 80333 München  Opening hours only with appointment		STILWERK HAMBURG  +49 40 - 5 37 99 50 20  info@nohrd.de  Große Elbstraße 68, 22767 Hamburg  Mon/Wed/Thu/Fri 10:00 - 19:00  Sat 10:00 - 18:00	
AT		CH		UK	
WATERROWER AND NOHRD GMBH  +43 1 4026542  +43 1 402654289  info@nohrd.at  Kinderspitalgasse 13/4, 1090 Wien		WATERROWER AND NOHRD GMBH  +49 59 21 - 17 98 400  info@waterrower.de  Otto-Hahn-Straße 75, 48529 Nordhorn		WATERROWER  +44 (0)20 8749 9090  19 Acton Park Estate London W3 7QE, UK  Mon - Fri 09:00 - 17:00	
USA		CAN		AUS	
WATERROWER  1 (800) 852 2210  560 Metacom av, Warren, RI 02885		WATERROWER  1 (800) 852 2210  560 Metacom av, Warren, RI 02885		WATERROWER  +61 2 9898 1405  72 South St, Rydalmere NSW 2116, Australia  Mon - Fri 09:00 - 17:00	

Please find a detailed overview including address and opening hours for all stores of the Sport-Tiedje Group in Germany and abroad on the following website:

www.sport-tiedje.com/en/stores

WE LIVE FITNESS

WEBSHOP AND SOCIAL MEDIA

Sport-Tiedje is Europe's largest specialist store for home fitness equipment with currently over 70 stores and one of the world's most renowned online mail order companies for fitness equipment. Private customers order via the 25 web shops in the respective national language or have their desired equipment assembled on site. In addition, the company supplies fitness studios, hotels, sports clubs, companies and physio practices with professional equipment for endurance and strength training.

Sport-Tiedje offers a wide range of fitness equipment from renowned manufacturers, high-quality in-house developments and comprehensive services, such as a build-up service and sports scientific advice before and after the purchase. The company employs numerous sports scientists, fitness trainers and competitive athletes.

Visit us also on our social media platforms or our blog!



www.sport-tiedje.co.uk
www.sport-tiedje.de/blog



www.facebook.com/SportTiedje



www.instagram.com/sporttiedje



www.youtube.com/user/sporttiedje

TAURUS

 cardiostrong

BODYCRAFT

 cardiojump

 **DUKEFITNESS**

DARWIN

Notes

Notes

