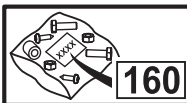
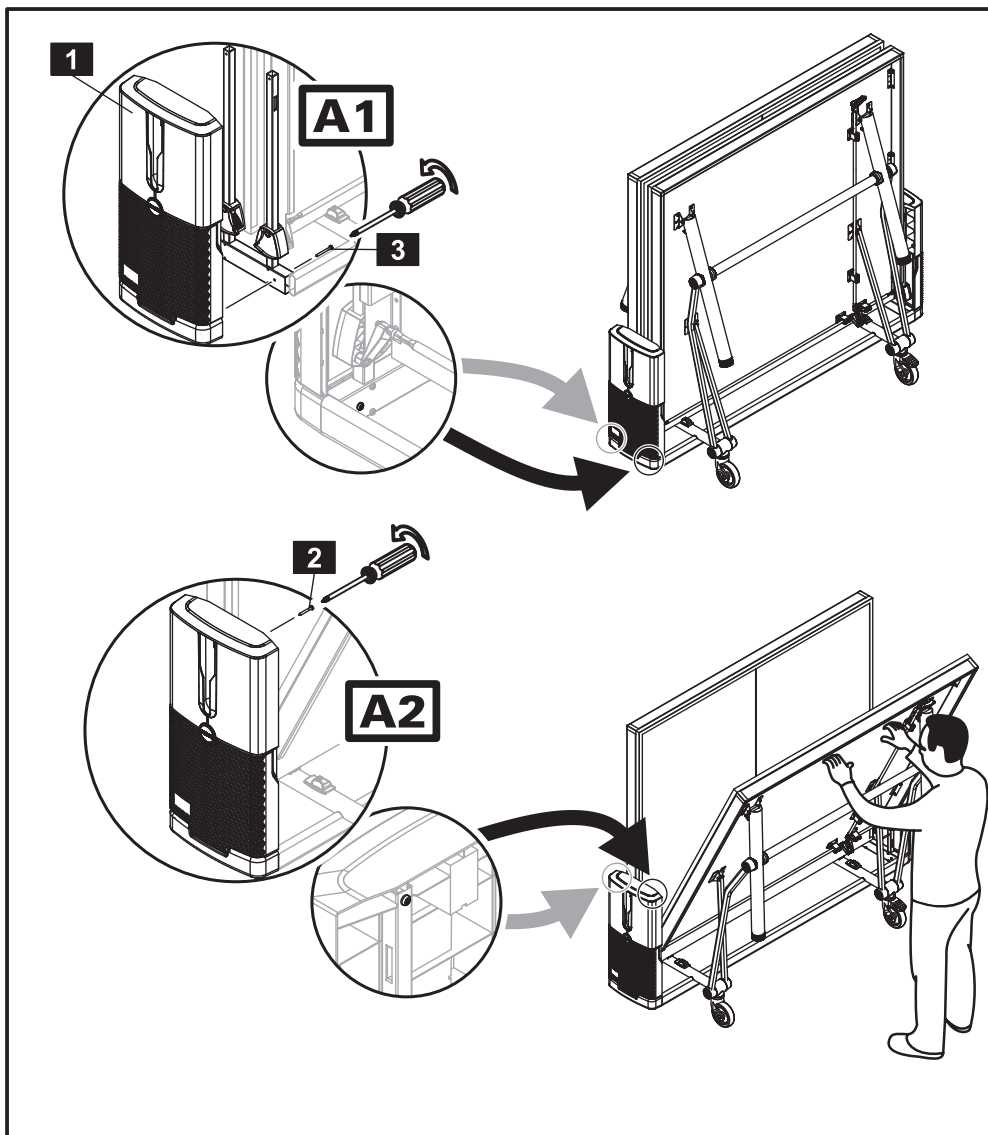
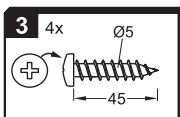
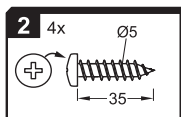
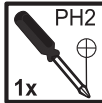
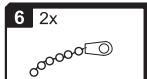
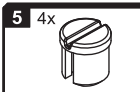
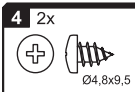
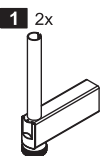
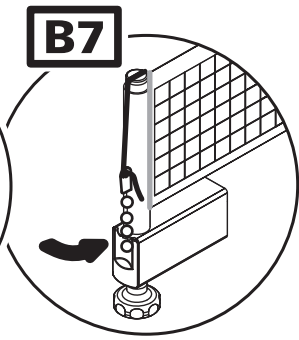
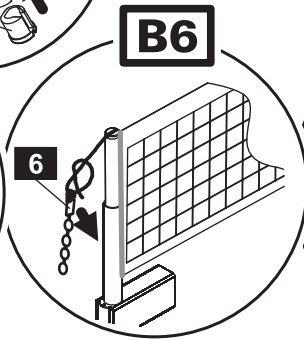
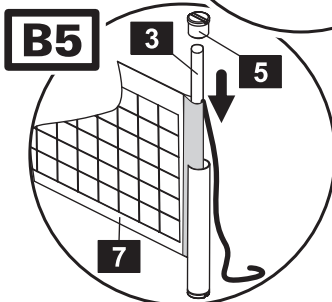
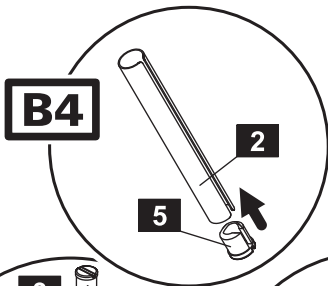
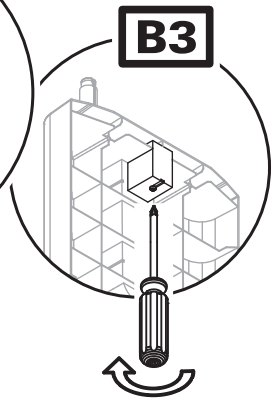
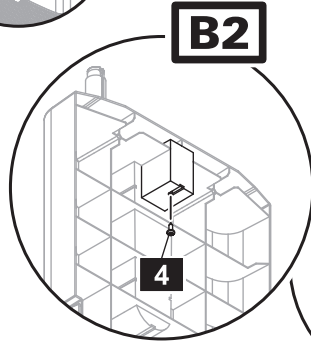
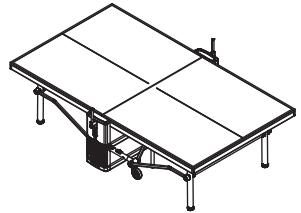
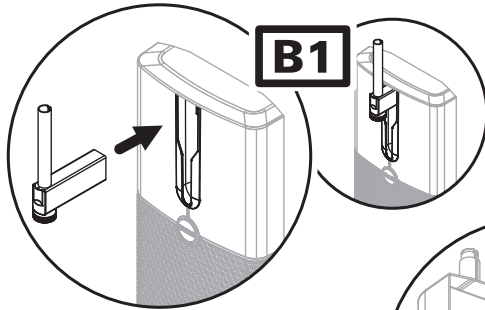

A

865.299.032

2x**1** 2x

B**2x****7** 1x