

TAURUS®

Assembly and Operating Instructions

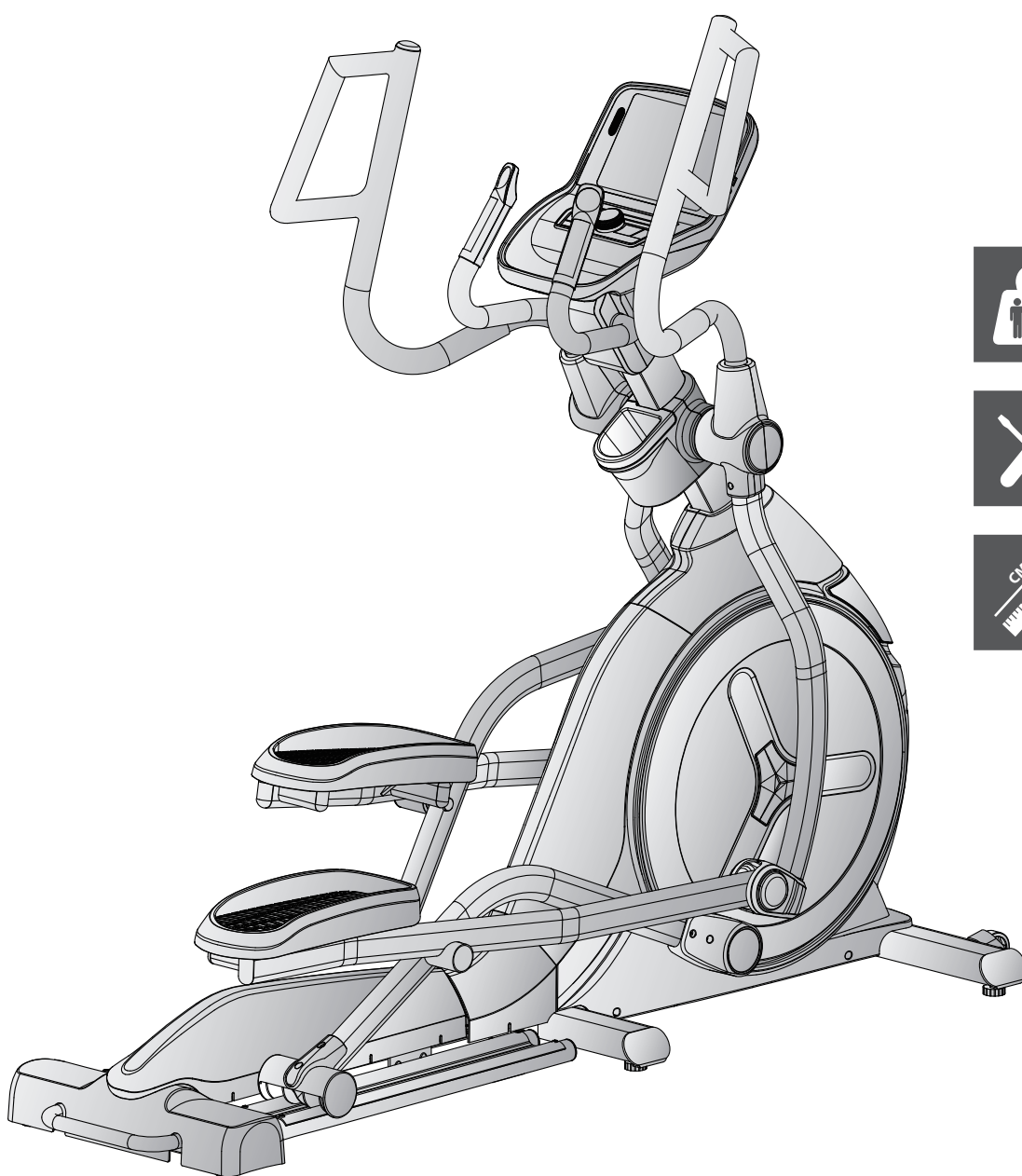

max. 180 kg



~ 90 Min.



127 kg

L 211 | W 82 | H 188

FSTFFX99TFT.01.02

Art. No. TF-FX99-TFT

Elliptical Trainer FX9.9 Touch

Content

1	GENERAL INFORMATION	8
1.1	Technical Data	8
1.2	Personal Safety	9
1.3	Electrical Safety	10
1.4	Set-Up Place	11
2	ASSEMBLY	12
2.1	General Instructions	12
2.2	Scope of Delivery	13
2.3	Assembly	14
3	OPERATING INSTRUCTIONS	23
3.1	Console Display	23
3.2	Button Functions	25
3.3	Programmes	26
3.3.1	Quick Start	26
3.3.2	Target programmes	26
3.3.3	Pre-set programmes	26
3.3.4	User-defined programmes	31
3.3.5	Heart rate-oriented programmes	32
3.3.6	Watt programme	33
3.4	Fitness Test	34
3.5	Media	35
3.6	Wireless Connection and Fitness Apps	36
4	STORAGE AND TRANSPORT	37
4.1	General Instructions	37
4.2	Transportation Wheels	37
5	TROUBLESHOOTING, CARE AND MAINTENANCE	38
5.1	General Instructions	38
5.2	Faults and Fault Diagnosis	38
5.3	Error Codes and Troubleshooting	39
5.4	Maintenance and Inspection Calendar	40
6	DISPOSAL	40
7	RECOMMENDED ACCESSORIES	41

8	ORDERING SPARE PARTS	42
8.1	Serial Number and Model Name	42
8.2	Parts List	43
8.3	Exploded Drawing	48
9	WARRANTY	49
10	CONTACT	51

Dear customer,

Thank you for choosing a high-quality equipment of the brand TAURUS®. Taurus offers sports and fitness equipment for the sophisticated home sport and the equipment of fitness studios and business customers. With Taurus fitness equipment, the focus is on what sport is all about: maximum performance! Therefore, the equipment is developed in close consultation with athletes and sports scientists. Because athletes know best what makes perfect fitness equipment.

Further information can be found at www.fitshop.com.

Intended Use

The equipment may only be used for its intended purpose.

The equipment is suitable for home use and semi-professional use (e.g. hospitals, clubs, hotels, schools, etc.). The equipment is not suitable for commercial or professional use (e.g. fitness studio).

Legal Notice

Fitshop GmbH
Europe's No. 1 for home fitness

International Headquarters
Flensburger Straße 55
24837 Schleswig
Germany

Management:
Christian Grau
Sebastian Campmann
Dr. Bernhard Schenkel
No. HRB 1000 SL
Local Court Flensburg
European VAT Number: DE813211547

Disclaimer

© TAURUS is a registered brand of the company Fitshop GmbH. All rights reserved. Any use of this trademark without the explicit written permission of Fitshop is prohibited.

Product and manual are subject to change. Technical data can be changed without advance notice.

FITSHOP

Europe's No.1 for Home Fitness

ABOUT THIS MANUAL

Please carefully read the entire manual before installation and first use. The manual will help you to quickly set up the system and explains how to safely use it. Make sure that all persons exercising with the equipment (especially children and persons with physical, sensory, mental or motor disabilities) are informed about this manual and its contents in advance. In case of doubt, responsible persons must supervise the use of the equipment.

Due to ongoing changes and software optimisations, the manual may have to be updated. If you notice any discrepancies during assembly or use, please refer to the manual uploaded to the webshop. The latest manual is always available there.

This equipment has been manufactured according to the latest safety knowledge. As far as possible, potential safety hazards which could cause injury have been eliminated. Make sure to carefully follow the instructions and that all parts are securely in place. If required, read through the instructions again to correct any mistakes.



Training devices must be classified according to accuracy and use. Accuracy classes are only applicable to devices that display training data.

Accuracy classes

Class A: high accuracy.

Class B: medium accuracy.

Class C: low accuracy.

The use classes explain the intended use of the training device.

Use classes

Class S (studio): professional and/or commercial use.

These training devices are intended for the use in training rooms of facilities such as sports clubs, school facilities, hotels, clubs and studios whose access and supervision is specifically regulated by the owner (person with legal responsibility).

Class H (home use): use at home.

These stationary training devices are intended for the use in private homes where access to the training device is regulated by the owner (person with legal responsibility).

Please pay close attention to the safety and maintenance instructions given here. The contract partner cannot be held liable for damage to health, accidents or damage to the equipment when it is not used in accordance with these instructions.

The following safety instructions may appear in this manual:

► **ATTENTION**

This notice indicates potentially hazardous situations which, if not avoided, may result in property damage.

⚠ **CAUTION**

This notice indicates potentially hazardous situations which, if not avoided, may result in slight or minor injuries!

⚠ **WARNING**

This notice indicates potentially hazardous situations which, if not avoided, may result in death or serious injuries!

⚠ **DANGER**

This notice indicates potentially hazardous situations which, if not avoided, will result in death or serious injuries!

ⓘ **NOTICE**

This notice indicates further useful information.

Retain these instructions in a safe place for future reference, maintenance or when ordering replacement parts.

1.1 Technical Data

TFT Display:

- + Training time in min.
- + Speed in km/h
- + Training distance in km
- + Calories in kcal
- + Resistance level
- + Incline in %
- + Heart rate (using the hand pulse sensors or a chest strap)
- + RPM (Rotations per minute)
- + Watts

Brake system: Electro-magnetic induction brake
Resistance levels: 32

Wattage
Adjustable range in the watt programme: 10-350 W
Min. and max. Watt at 60 RPM: 50-400 W
Min. and max. Watt at 100 RPM: 148-765W

User memory: 4
Training programmes in total: 43
Quick-Start Programmes: 1
Target programmes: 3
Heart rate programmes: 3
Pre-set programmes: 32
User defined programmes: 4 (one per user)
Wattprogrammes: 1

Fitness Test: 1

Stride length: max. 56 cm
Stride height: 14 cm
Transfer ratio: 1:8.75
Flywheel mass: 10 kg

Weight and dimensions:

Packed dimension (LxWxH): 125 cm x 65 cm x 95 cm
Assembled dimensions (LxWxH): 211 cm x 82 cm x 188 cm
Article weight (gross, incl. packaging): 150.6 kg
Article weight (net, without packaging): 127 kg

Maximum user weight: 180kg
Use class: S

1.2 Personal Safety

DANGER

- + Before you start using the equipment, you should consult your physician that this type of exercise is suitable for you from a health perspective. Particularly affected are persons who: have a hereditary disposition to high blood pressure or heart disease, are over the age of 45, smoke, have high cholesterol values, are overweight and/or have not exercised regularly in the past year. If you are under medical treatment that affects your heart rate, medical advice is absolutely essential.
- + Note that excessive training can seriously endanger your health. Please also note that heart rate monitoring systems can be inaccurate. If you notice any signs of weakness, nausea, dizziness, pain, shortness of breath, or other abnormal symptoms, stop exercising immediately and seek advice from your doctor if necessary.
- + The owner must communicate all warnings and instructions to the user.

WARNING

- + This equipment may not be used by children under the age of 14.
- + Children should not be allowed unsupervised access to the equipment.
- + Persons with disabilities must have a medical license and must be under strict observation when using the equipment.
- + Remember that your device does not have a freewheel function. Therefore moving parts cannot be stopped immediately.
- + Note that the individual physical power required to perform an exercise may differ from the displayed mechanical power.
- + When ascending and descending, make sure that one of the treads is in the lowest position.
- + The equipment is strictly for use by one person at a time.
- + Keep your hands, feet and other body parts, hair, clothing, jewellery and other objects well clear of moving parts.
- + During use, wear suitable sports clothing rather than loose or baggy clothing. When wearing sports shoes, make sure they have suitable soles, preferably made of rubber or other non-slip materials. Shoes with heels, leather soles, studs or spikes are unsuitable. Never exercise barefoot.

CAUTION

- + If your equipment needs to be connected to the power supply with a mains cable, make sure that the cable is not a potential tripping hazard.
- + Make sure that nobody is within the range of motion of the equipment during training so as not to endanger you or other persons.
- + Do not insert any objects of any kind into the openings of the device.
- + Be aware that if adjustment devices are left protruding, they may impede the user's movement.

1.3 Electrical Safety

DANGER

- + In order to reduce the risk of an electric shock, always unplug the equipment from the mains socket immediately after your workout, before assembly or dismantling, and before maintenance or cleaning. Do not pull on the cable.

WARNING

- + Do not leave the equipment unattended while the mains cable is plugged into the mains socket. During your absence, the mains cable must be removed from the mains socket to prevent improper use by third parties or children.
- + If the mains cable or plug is damaged or defective, contact your contract partner. Until repair, the equipment must not be used.

ATTENTION

- + The equipment requires a mains connection of 220-230 V with 50 Hz mains voltage.
- + The equipment may only be connected directly to an earthed socket using the supplied mains cable. Extension cables must conform to VDE guidelines. Always completely unwind the mains cable.
- + The socket must be protected by a fuse with a minimum fuse rating of "16 A, slow blow".
- + Do not make any changes to the mains cable or the mains plug.
- + Keep the mains cable away from water, heat, oil and sharp edges. Do not route the mains cable underneath the equipment or under a carpet or rug, and do not place any objects on top of it.
- + If your purchased item is equipped with a TFT console, software updates must be carried out regularly. Follow the instructions on the console to perform the update(s).
- + The software systems on gym equipment with TFT consoles are set up only for the pre-installed apps. Do not install any additional apps.

NOTICE

- + The pre-installed apps on TFT consoles are produced and provided by external manufacturers. Fitshop does not take any responsibility for the availability, functionality or contents of these apps.

1.4 Set-Up Place

WARNING

- + Do not place the equipment in main corridors or escape routes.

CAUTION

- + Choose a location in which to place the equipment such that there is enough free space/clearance to the front, the rear and to the sides of the equipment.
- + The training room should be well ventilated during training and not be exposed to any draughts.
- + Choose the place in which to set up the equipment such that there is enough free space/clearance to the front, the rear and to the sides of the equipment.
- + The free area in the direction from which the exercise equipment is accessed must be at least 0.6 m larger than the exercise area.
- + The set-up and mounting surface of the equipment should be flat, loadable and solid.

ATTENTION

- + The device may only be used in one building, in sufficiently tempered and dry rooms (ambient temperatures between 10°C and 35°C). The equipment should not be used outdoors or in rooms with high humidity (over 70%) like swimming pools.
- + A floor protective mat/equipment underlay can help to protect high-quality floor coverings (parquet, laminate, cork, carpets) from dents and sweat and can help to level out slight unevenness.
- + For Class S equipment, the exercise equipment may only be used in areas where access, supervision and control are specifically regulated by the owner.

2.1 General Instructions



DANGER

- + Do not leave any tools, packaging materials such as foils or small parts lying around, as otherwise there is a danger of suffocation for children. Keep children away from the equipment during assembly.



WARNING

- + Pay attention to the instructions attached to the equipment in order to reduce the risk of injuries.



CAUTION

- + Ensure to have sufficient room for movement in each direction during assembly.
- + The assembly of the equipment must be carried out by at least two adults. If in doubt, seek the help of a third technically skilled person.



ATTENTION

- + To prevent damage to the equipment and the floor, assemble the equipment on a mat or packaging board.



NOTICE





- + In order to make the assembly as simple as possible, some screws and nuts to be used can already be pre-assembled.
- + Ideally, assemble the equipment at its later set-up place.

2.2 Scope of Delivery

The scope of delivery consist of the following parts. At the beginning, check whether all parts and tools belonging to the device are included in the scope of delivery and whether damage has occurred. In the event of complaints, the contractual partner must be contacted directly.

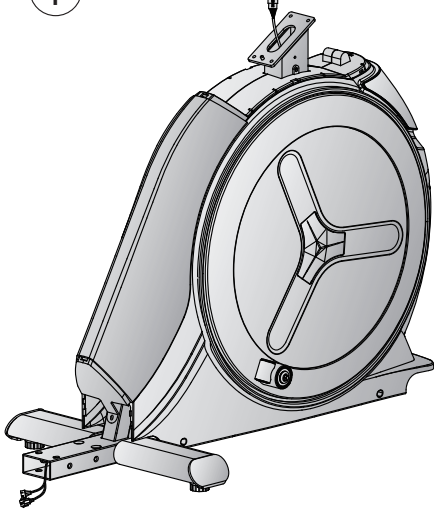
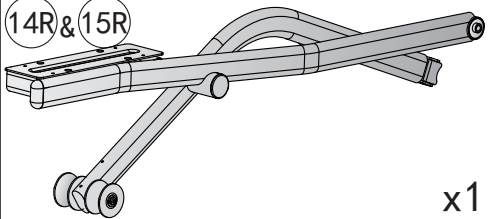
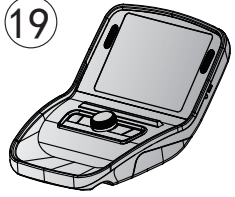
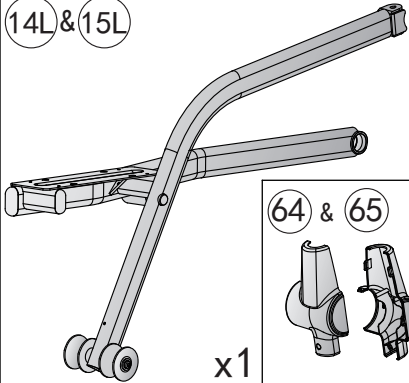
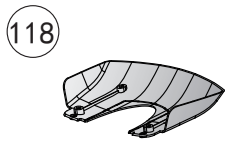
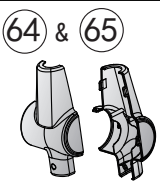
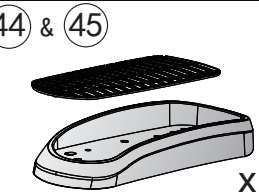
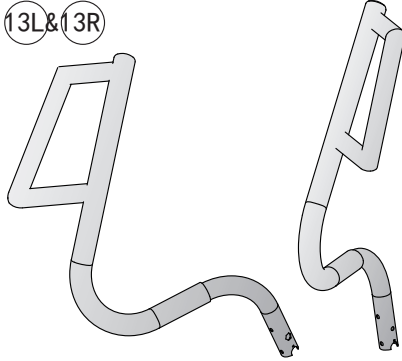
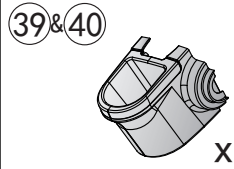
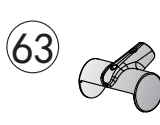
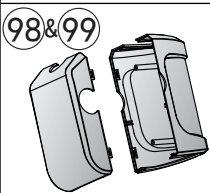
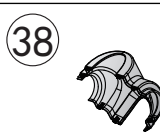
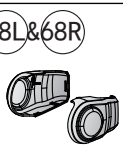
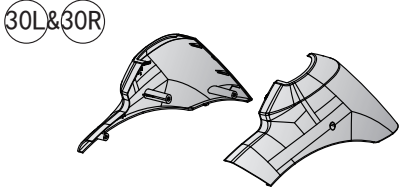
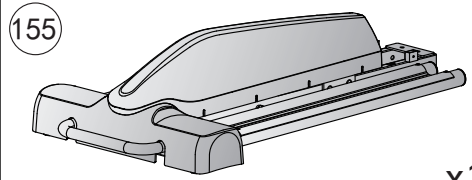
⚠ CAUTION

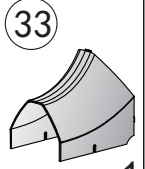
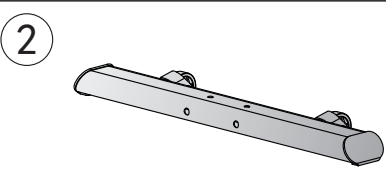
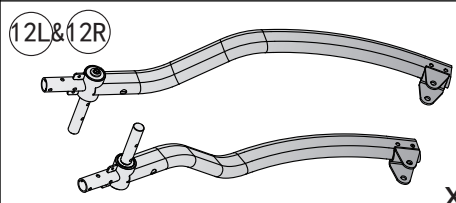
If parts of the scope of delivery are missing or damaged, the assembly must not be carried out.

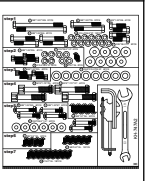
 <p>1</p> <p>x1</p>	 <p>14R&15R</p> <p>x1</p>	 <p>19</p> <p>x1</p>	
	 <p>14L&15L</p> <p>x1</p>	 <p>118</p> <p>x1</p>	
	 <p>64 & 65</p> <p>x2</p>	 <p>44 & 45</p> <p>x2</p>	
	 <p>13L&13R</p> <p>x1</p>	 <p>39&40</p> <p>x1</p>	 <p>63</p> <p>x2</p>
	 <p>98&99</p> <p>x1</p>	 <p>38</p> <p>x1</p>	 <p>68L&68R</p> <p>x2</p>
 <p>30L&30R</p> <p>x1</p>	 <p>155</p> <p>x1</p>	 <p>117</p> <p>x1</p>	 <p>33</p> <p>x1</p>
 <p>2</p> <p>x1</p>	 <p>12L&12R</p> <p>x1</p>	 <p>71</p> <p>x2</p>	 <p>x1</p>

2.3 Assembly

Before assembly, take a close look at the individual assembly steps shown and carry out the assembly in the order given.

NOTICE

- + First loosely screw all parts together and check that they fit properly. Tighten the screws using the tool only when you are instructed to do so.
- + If you have difficulty recognising the graphics, we recommend that you open and/or download the PDF instructions stored in the webshop on your end device (e.g. smartphone, tablet or PC). There you have the option of zooming in closer. Please note that the Adobe Acrobat Reader programme must be installed on your end device in order to open the file.

Step 1: Assembling the front and rear feet







1. Screw the frontal foot (2) to the main frame (1) with two hexagonal screws (3), two hexagonal screws (5) and four spring washers (4). Only hand tighten the screws in place.
2. Connect the incline cable (158) and the control cable (167) together.
3. Connect both incline control cables (165 & 166) together.

ATTENTION

In the following step please pay attention that you don't clamp the cables between the frames.

4. Screw the rear foot with the rails (155) to the main frame (1) with eight washers (51), eight spring washers (4), four hexagonal screws (147), four hexagonal screws (148) and hand tighten the screws in place.



3		M8*1.25*120L	x2
5		M8*1.25*70L	x2
147		M8*1.25*55L	x4
148		M8*1.25*35L	x4
4		D15.4*D8.2*2T	x12
51		D25*D8.5*2T	x8

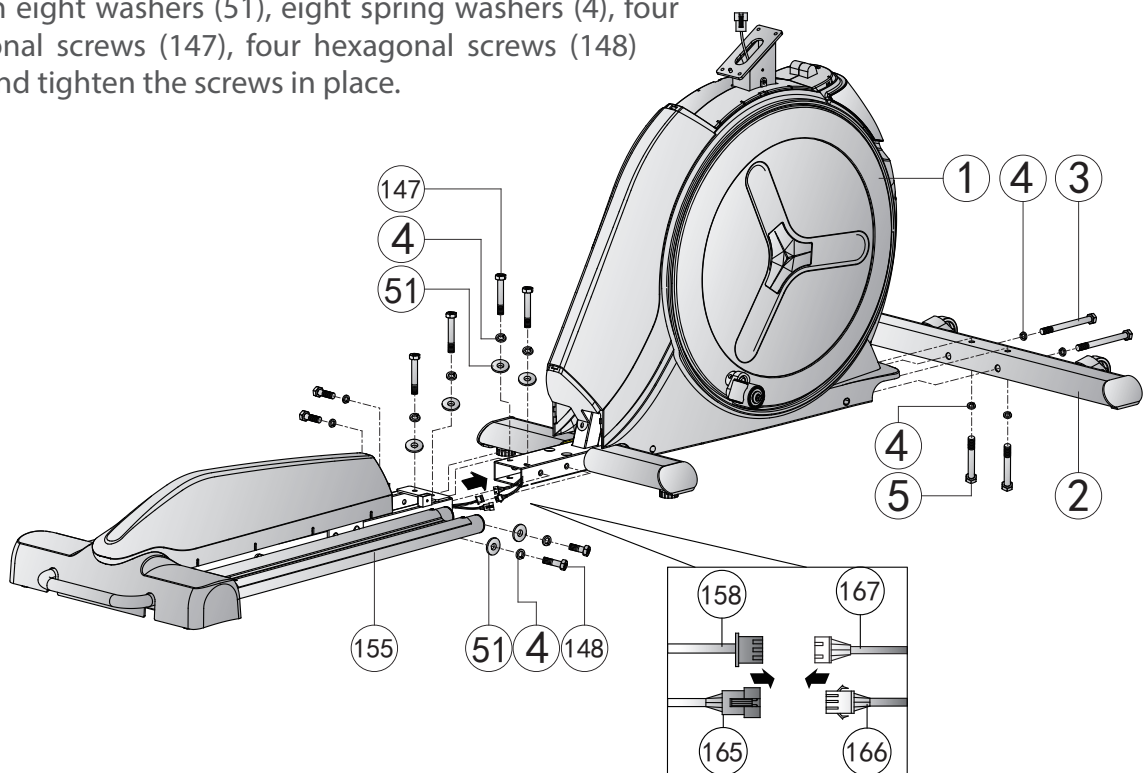

Step 2: Assembling the console mast

1. Connect the console cable in the mast (101) with the console cable in the main frame (102).
2. Connect the signal cable in the mast (178) with the signal cable in the main frame (179).

► ATTENTION

In the following step please pay attention that you don't clamp the cables between the frames.

3. Screw the console mast (11) to the main frame (1) with four washers (7), four spring washers (4), four screws (119) and hand tighten the screws in place.
4. Screw the rear cover (33) to the frame with two screws (96) and hand tighten the screws in place.

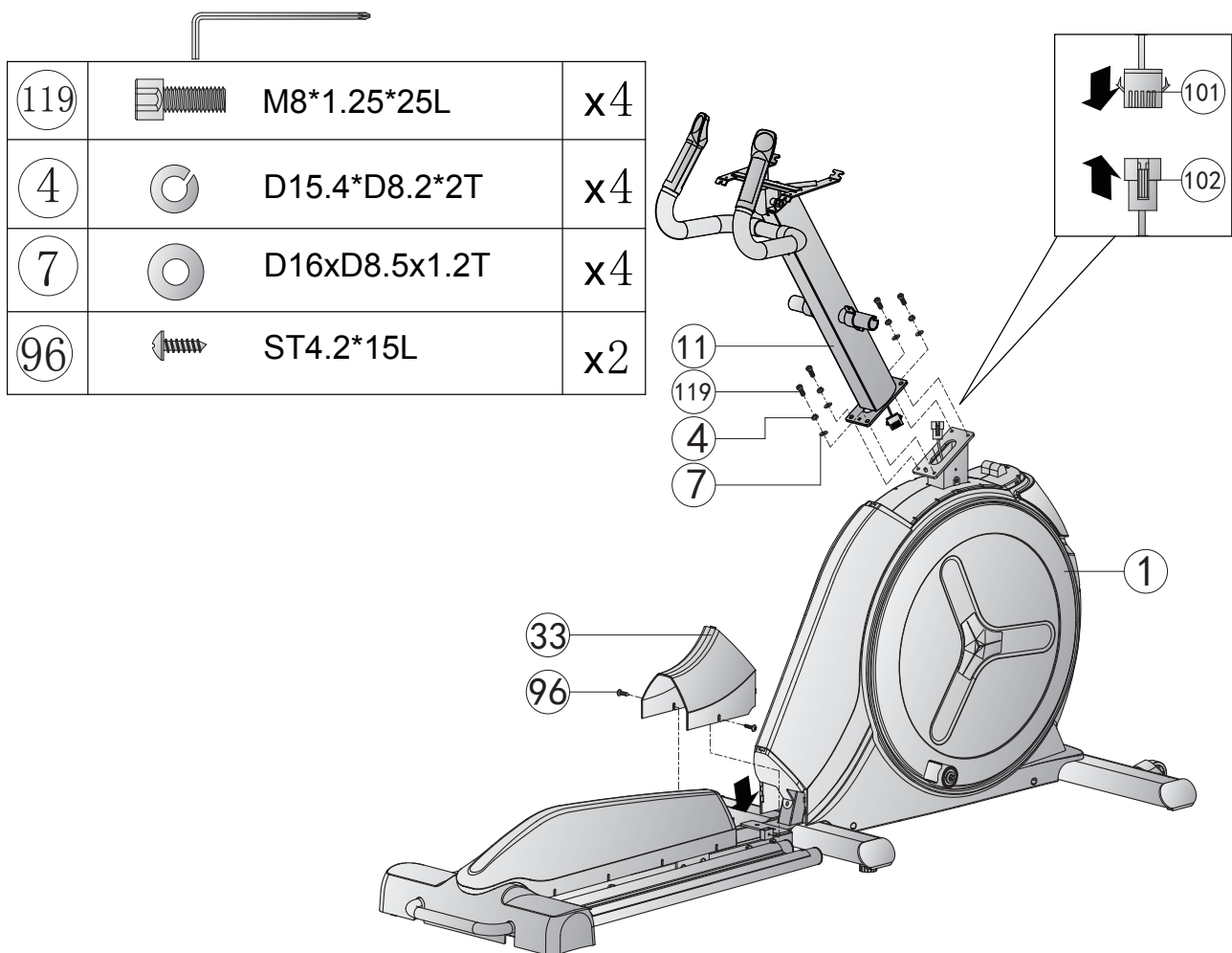

Step 3: Mounting the arms

1. Screw the left arm (12L) onto the console mast (11) with two Allen screws (6).
2. Screw the right arm (12R) onto the console mast (11) with two Allen screws (6). Only hand tighten the screws in place.



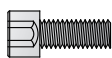

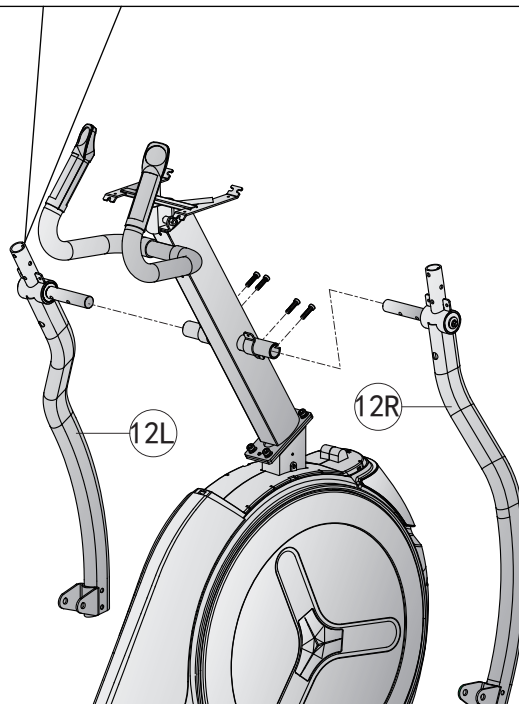
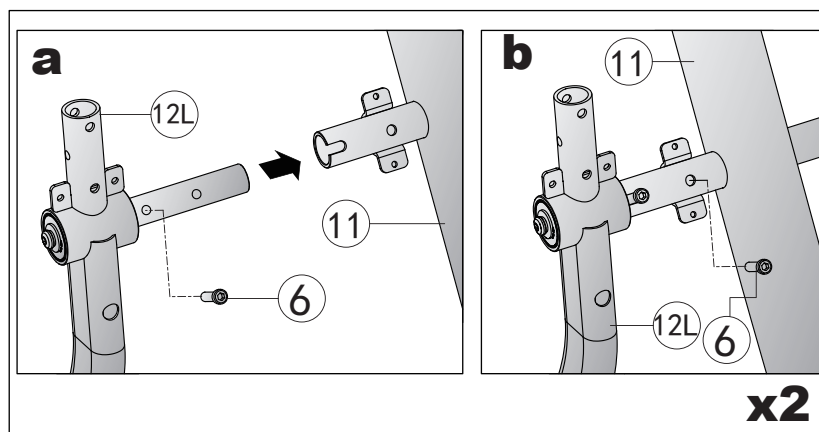

6		M8*1.25*20L	x4
---	--	-------------	----



Step 4: Mounting the pedals

1. Mount the right and left pedal poles (14R/14L) on their respective sides of the main frame (1), each with two washers (73), one Allen screw (72) and one locking nut (74) (see fig. 4-1).
2. Mount the right and left pedal mounts (15R/15L) on their respective arm (12R/12L), each with two washers (73), one Allen screw (72) and one locking nut (74) (see fig. 4-2).
3. Mount the right and left pedals (44) onto the pedal mounts (15R/15L), each with four screws (128) and place the pedal mats (45) on both pedals (44) (see fig. 4-3).
4. Only hand tighten the screws in place.



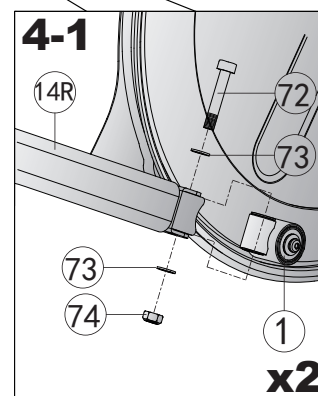
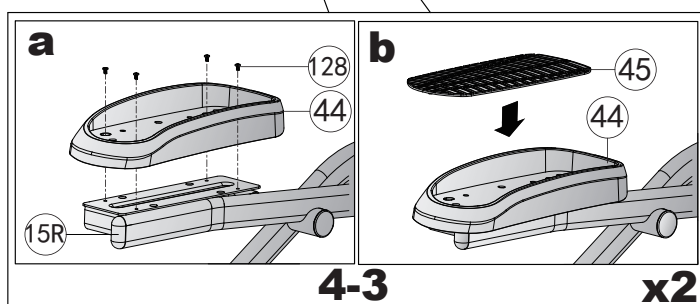
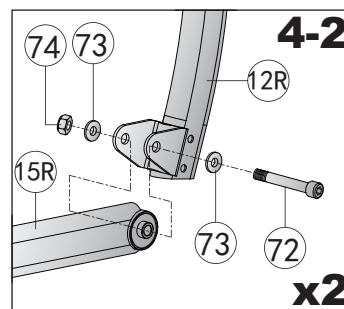
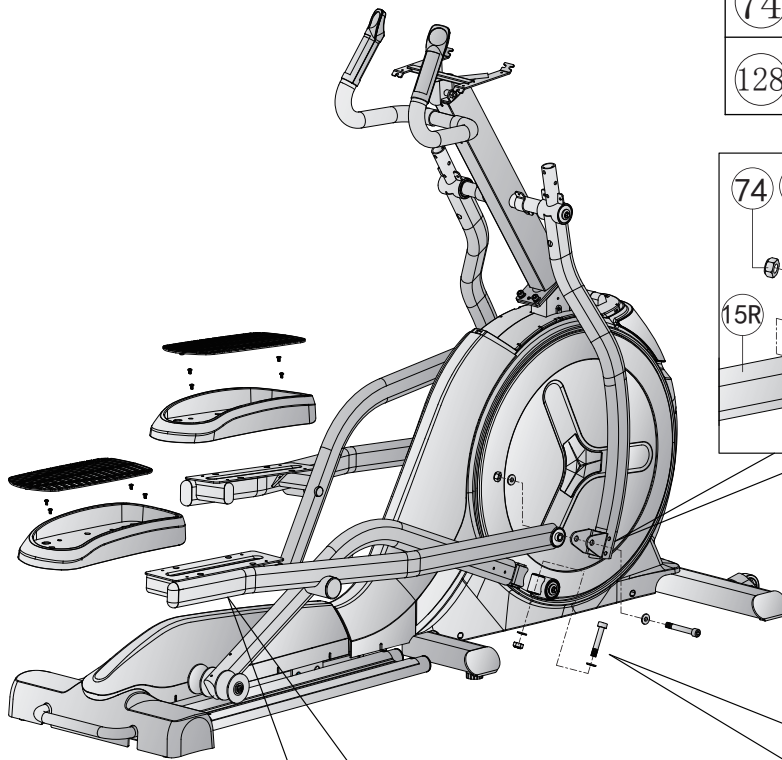

72		M12*1.75*70L	x4
73		D24*D13.5*D2.5T	x8
74		M12*1.75*12T	x4
128		M6*1.0*15L	x8



Step 5: Mounting the handles

Screw the right and left handles (13R/13L) onto the respective arm (12R/12L), each with three curved washers (9), three Allen screws (8) and three locking nuts (10) (see figs. 5-1 & 5-2). Only hand tighten the screws in place.

8	 M8*1.25*50L	x6
9	 D22*D8.5*1.5T	x6
10	 M8*1.25*8T	x6

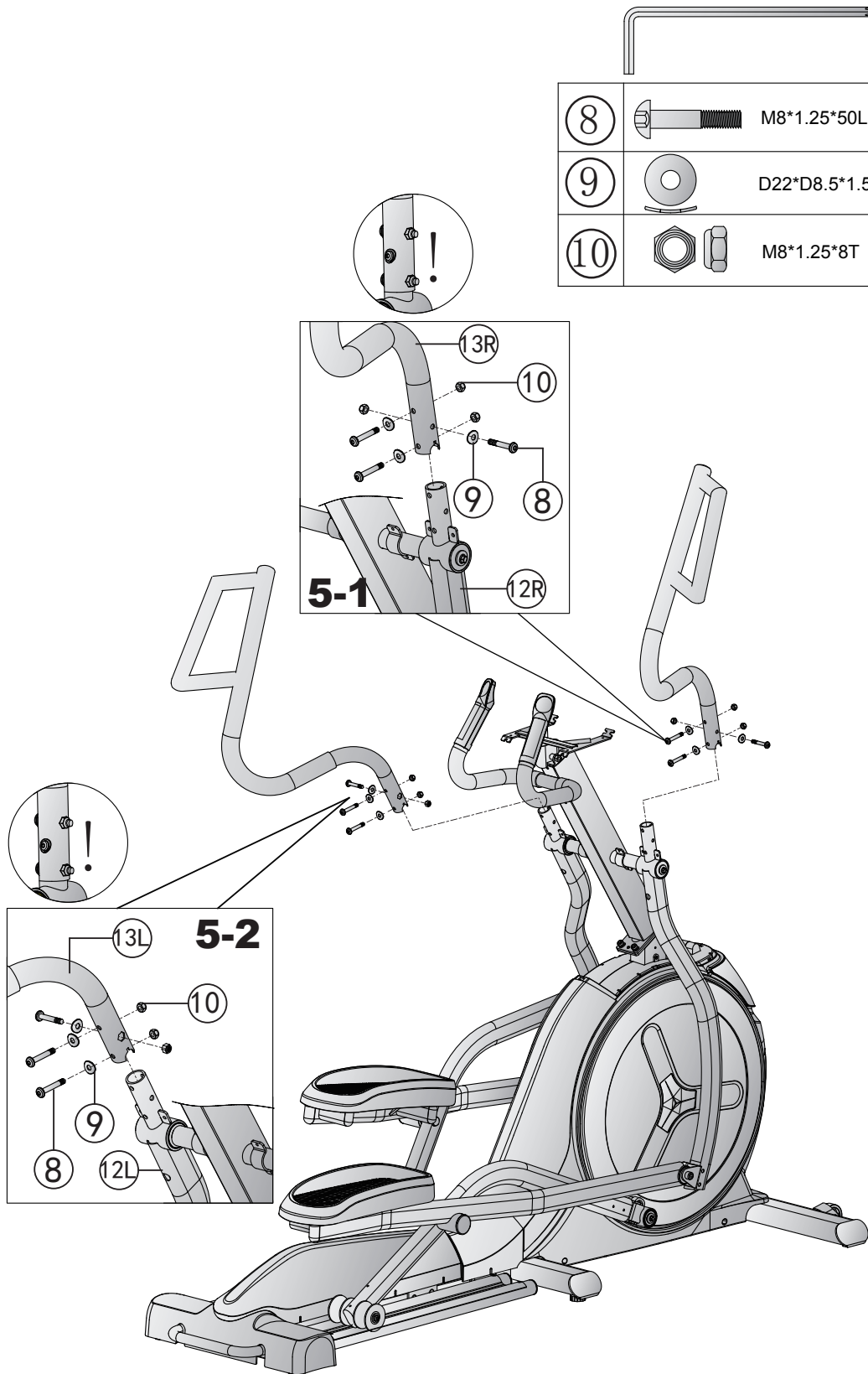

Step 6: Mounting the console

1. Connect the console cable from the console (100) with the console cable from the console mast (101) (see fig. 6-1).
2. Connect the first hot-key cable from the console (106) with the first hot-key cable from the console mast (108) and the second hot-key cable from the console (107) with the second hot-key cable from the console mast (109) (see fig. 6-1).
3. Connect the signal cable from the console (177) with the signal cable from the console mast (178) (see fig. 6-1).

► ATTENTION

Pay attention to not pinch the cables during the next steps.

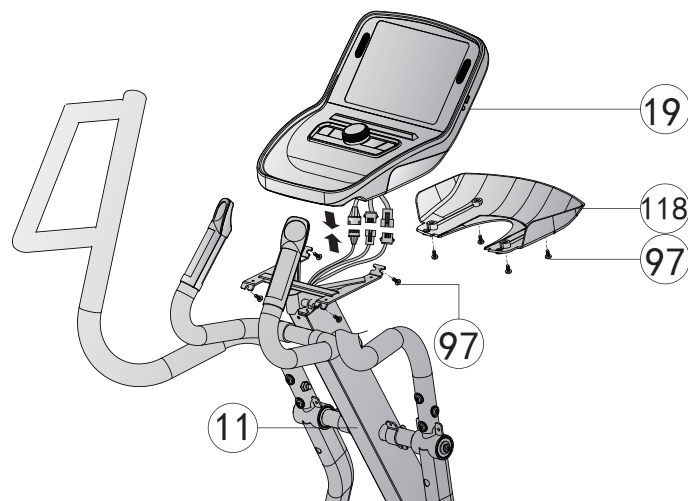
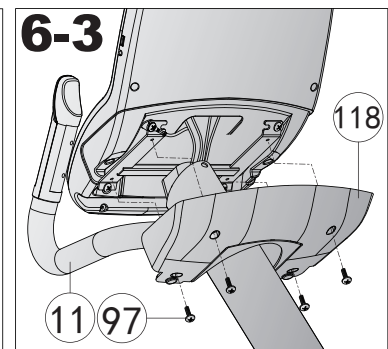
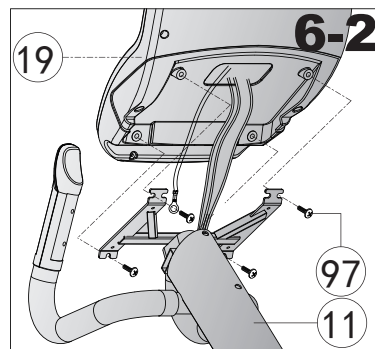
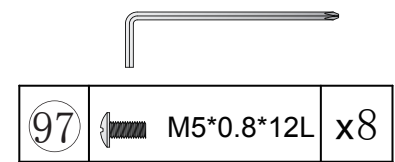
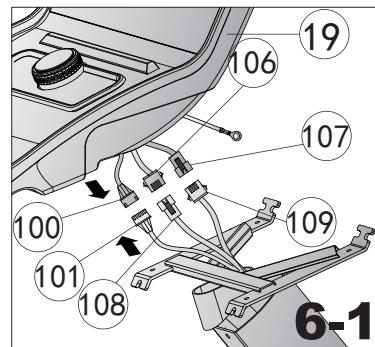

4. Guide the ground cable through the console bracket on the console mast (11) and mount the console (19) to the console mast (11) with four screws (97) (see fig. 6-2).
5. Use one of the screws (97) to fix the ground cable (see fig. 6-2) and hand-tighten the screws.
6. Screw the cover (118) onto the console mast (11) with four screws (97) (see fig. 6-3) and hand tighten the screws in place.



Step 7: Mounting the covers

1. Screw the front cover (99) under the console (19) onto the console mast (11) with two screws (96) and hand tighten the screws in place. Clip the rear cover (98) onto the front cover (99) (see fig. 7-1).
2. Screw the rear part of the water bottle holder (39) onto the console mast (11) with four screws (96) and hand tighten the screws in place. Clip the front cover of the water bottle holder (38) to the rear part (39) (see fig. 7-2).
3. Screw the front covers of the arms (64) onto both arms (12R/12L), each with two screws (96) (see fig. 7-3) and hand tighten the screws in place.
4. Clip the rear cover for the arms (65) onto the front cover (64) and screw it onto the arms (12R/12L), each with one screw (96) (see fig. 7-3).
5. Screw the left protective cover (30L) onto the main frame (1) with two screws (96) and one screw (97) and hand tighten the screws in place.
6. Clip the right protective cover (30R) onto the left protective cover (30L) and screw it onto the main frame (1) with one screw (97) (see fig. 7-4).
7. Screw the outer cover of the pedal mount (68R) onto the outer side of the pedal mount (15R/15L), each with two screws (96) and hand tighten the screws in place. Clip the inner cover (68L) onto the outer cover (68R) (see fig. 7-5).
8. Screw the wheel covers (63) on both sides of the crosstrainer, each with two screws (97) (see fig. 7-6) and hand tighten the screws in place.
9. Screw the axial covers (71) on both sides of the crosstrainer, each with two screws (97) (see fig. 7-7) and hand tighten the screws in place.



96		ST4.2*15L	x18
97		M5*0.8*12L	x10

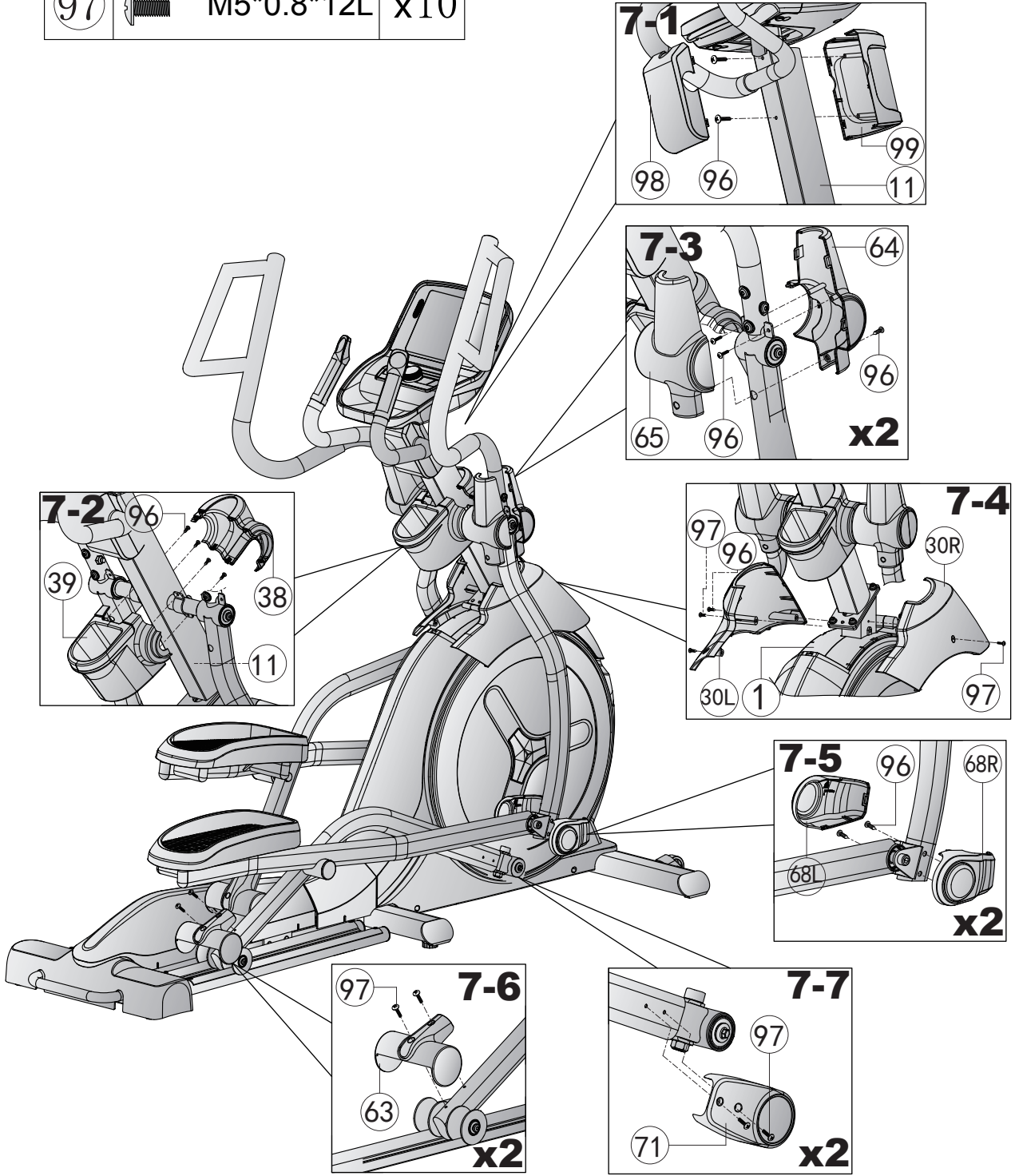

Step 8: Adjusting the feet

The crosstrainer can be stabilised on un-even surfaces with the adjustable feet.

1. Lift up the crosstrainer on one side to gain access to the adjustable feet underneath the frame.
2. Turn the screw clockwise to unscrew the foot, lifting the crosstraining at that point.
3. Turn the screw anti-clockwise to lower the crosstrainer at that point.

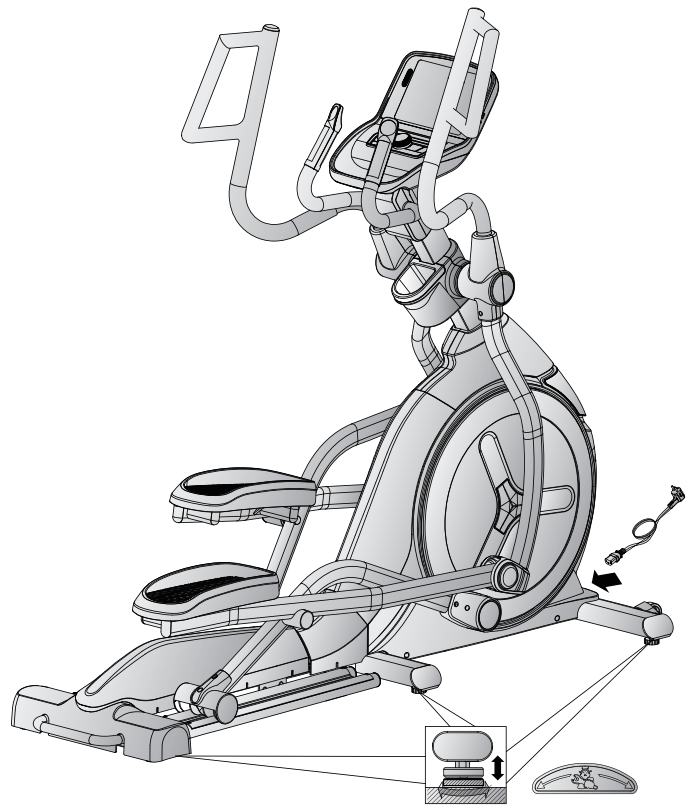

Step 9: Connecting the crosstrainer to the mains supply

▶ ATTENTION

The crosstrainer should not be plugged into a power board, as it cannot be guaranteed that the crosstrainer will be supplied with sufficient power. This could also lead to technical errors occurring.

First connect the power cord (117) to the crosstrainer and then plug it into the wall socket, making sure the electrical prerequisites covered in the chapter about electrical safety are met.

Correctly Getting On and Off

1. To get on, grip the handles with both hands and first step onto the left pedal with your left foot or onto the right pedal with your right foot and then place your foot onto the other pedal.
2. To get off, grip the handles with both hands and place one foot next to the equipment and then the other foot.

3 OPERATING INSTRUCTIONS

① NOTICE

- + Familiarise yourself with all the functions and setting options of the device before starting training. Have the proper use of this product explained to you by a specialist.
- + Always start your training with low intensity and increase evenly and gently. End your training with a cool-down phase. If you are unsure, please consult your physician.

3.1 Console Display



DISPLAY	DESCRIPTION
Level	+ Display of the current resistance level + Display range: 1–32
Time	+ Display of the training time in minutes + Display range: 00:00–999:59
Distance	+ Display of the training distance in km + Display range: 0.0–99.9
Calories	+ Display of the calories in kcal + Display range: 0–9999
Puls	+ Display of current heart rate + Display range: 40–220

<p>Mets/Watt</p>	<p>+ Display of the MET or Watt value</p> <p><u>Definition:</u> MET or metabolic equivalent is used to measure the average metabolic rate for a person. MET describes the quantity of oxygen that an average person needs when in rest.</p> <p>1 MET = 3.5 ml/kg/min (The body consumes 3.5 milliliters of oxygen per kilogram per minute) is the amount of oxygen that the body needs when in rest.</p> <p>The more intensively the body works, the more oxygen is consumed and the higher the MET level. If you train at a level of seven METS, then you are working approximately 7 times harder than when in rest. Furthermore, you need 7 times as much oxygen than when in rest.</p> <ul style="list-style-type: none"> + Training between three to six METs is seen as moderate physical activity. + Training at more than six METs is seen as strong physical activity.
<p>Speed /RPM</p>	<p>+ Display of the current speed or the rotations per minute</p>

3.2 Button Functions



BUTTON	DESCRIPTION
Encoder	<ul style="list-style-type: none"> + Turn to increase or decrease setting values or the resistance level + Press to confirm the settings + Change between RPM and SPEED
FITNESS TEST	+ Press in main menu to get straight to the fitness test
PROGRAM	+ Press in main menu to get to the pre-set programmes
START/STOP	<ul style="list-style-type: none"> + Start or pause the programme + Continue after pausing the programme

ⓘ IMPORTANT NOTE

To ensure that your equipment has the latest software version, please perform an update before using it for the first time. Proceed as follows:

1. Tap "Settings" in the lower right corner of the screen.
2. Tap "Wireless" and connect your equipment to the Internet.
3. Return to the settings.
4. Tap "System and Apps" and go to updates.
5. Tap "Update", to update the software.

Do not use or switch off the equipment during the update.

Check whether another update is available and carry it out as described above at regular intervals. If a new version is available, the display shows a white icon. Otherwise the icon will be grey.

3.3 Programmes

This equipment offers many different programmes. This includes: a quick start programme, target programmes, pre-set programmes, user-defined programmes, heart rate-oriented programmes and one fitness test.

3.3.1 Quick Start

When you are in the main menu, simply press START to start a training session via quick start. Alternatively you can also tap on „QUICK START“ in the main menu.

3.3.2 Target programmes

1. Tap on „GOAL“ in the main menu.
2. Choose either time, distance or calories as your target unit.

NOTICE

You can only choose one unit.

3. Set a value for your desired target unit.
4. Press START to start the programme.

The resistance level and incline can be adjusted manually during your training.

5. Press the STOP button to pause your training.

The resistance level is set to 0.

- 5.1. Press STOP on the display to end your training and an overview of the collected training data will be displayed.
- 5.2. Press START to continue with your training.

3.3.3 Pre-set programmes

1. Tap on „PROGRAM“ in the main menu.
2. Enter your gender, age, weight and the desired training time and press Next.
3. Choose one of the pre-set programmes.
4. Press START to start the programme.

The resistance level and incline can be adjusted manually during your training.

5. Press the STOP button to pause your training.

The resistance level is set to 0.

- 5.1. Press STOP on the display to end your training and an overview of the collected training data will be displayed.
- 5.2. Press START to continue with your training.

Programme		Setting time / 30 = time for each section														
		1	2	3	4	5	6	7	8	9	10	11	12	13	14	15
P1	LEVEL	2	2	4	4	3	3	4	3	5	4	2	2	5	5	3
	INCLINE	1	1	2	2	3	3	3	1	2	2	3	3	2	2	2
P2	LEVEL	2	2	5	5	4	4	6	4	6	4	2	2	4	4	2
	INCLINE	1	1	2	2	3	3	3	2	2	3	4	4	2	2	2
P3	LEVEL	2	2	5	5	4	4	5	4	5	4	2	2	3	3	2
	INCLINE	1	1	2	2	2	2	3	1	2	2	2	2	2	2	1
P4	LEVEL	3	3	6	6	7	7	5	8	5	9	6	6	4	4	3
	INCLINE	2	2	2	2	3	3	3	2	2	4	6	6	2	2	2
P5	LEVEL	3	3	6	6	7	7	5	8	6	7	6	6	4	4	3
	INCLINE	1	1	2	2	4	4	3	2	2	4	5	5	2	2	1
P6	LEVEL	5	5	11	11	9	9	7	8	12	10	8	8	7	7	6
	INCLINE	2	2	2	2	6	6	2	3	4	2	2	2	2	2	1
P7	LEVEL	5	5	9	9	10	10	7	7	10	7	5	5	7	7	5
	INCLINE	4	4	5	5	6	6	6	9	9	10	7	7	6	6	3
P8	LEVEL	5	5	7	7	9	9	11	10	11	9	5	5	6	6	5
	INCLINE	3	3	5	5	4	4	4	3	4	4	3	3	3	3	2
P9	LEVEL	5	5	7	7	8	8	8	9	8	9	6	6	6	6	5
	INCLINE	3	3	5	5	3	3	4	2	3	4	2	2	3	3	2
P10	LEVEL	5	5	6	6	8	8	6	6	8	8	9	9	6	6	6
	INCLINE	4	4	4	4	3	3	6	7	8	8	6	6	3	3	3
P11	LEVEL	7	7	11	7	7	11	7	7	11	7	7	11	7	7	11
	INCLINE	4	4	5	5	6	6	6	9	9	10	8	8	6	6	3
P12	LEVEL	7	7	10	10	10	12	12	12	15	15	15	17	17	20	20
	INCLINE	3	3	5	5	6	6	7	8	9	10	10	8	6	6	3
P13	LEVEL	7	7	7	10	10	10	12	12	12	15	15	15	17	17	17
	INCLINE	3	3	4	4	6	6	2	3	7	9	5	5	2	2	2
P14	LEVEL	7	7	7	10	10	10	15	15	15	17	17	20	20	20	20
	INCLINE	3	3	5	5	4	4	4	3	4	3	2	2	2	2	4
P15	LEVEL	7	7	7	7	12	12	12	12	12	15	15	15	15	15	17
	INCLINE	4	4	3	3	4	4	4	3	4	2	3	3	2	2	5
P16	LEVEL	7	7	7	10	10	12	15	17	20	20	17	15	12	10	10
	INCLINE	3	5	9	10	9	9	8	8	4	3	3	3	2	2	4
P17	LEVEL	8	11	16	21	21	13	8	8	11	16	21	21	13	8	8
	INCLINE	1	1	4	4	6	6	6	1	4	4	6	6	4	4	4

Programme		Setting time / 30 = time for each section														
		16	17	18	19	20	21	22	23	24	25	26	27	28	29	30
P1	LEVEL	3	2	2	4	4	5	5	5	6	5	6	3	3	3	3
	INCLINE	2	3	3	5	5	3	3	4	2	3	4	2	2	3	3
P2	LEVEL	2	2	2	4	4	6	6	8	7	8	6	2	2	3	3
	INCLINE	2	3	3	5	5	4	4	4	3	4	4	3	3	1	1
P3	LEVEL	2	2	2	4	4	5	5	5	6	5	6	3	3	3	3
	INCLINE	1	3	3	5	5	3	3	4	2	3	4	2	2	3	3
P4	LEVEL	3	4	4	2	2	6	6	8	6	3	2	6	6	2	2
	INCLINE	2	3	3	4	4	6	6	2	3	7	9	5	5	2	2
P5	LEVEL	3	2	2	5	5	5	5	4	4	6	4	2	2	3	3
	INCLINE	1	3	3	5	5	6	6	7	8	9	10	10	8	2	2
P6	LEVEL	6	7	7	5	5	7	7	9	11	10	11	9	9	5	5
	INCLINE	1	4	4	3	3	4	4	4	3	4	2	3	3	2	2
P7	LEVEL	5	6	6	8	8	7	7	7	6	7	6	5	5	5	5
	INCLINE	3	4	4	2	2	4	4	6	8	7	8	6	6	2	2
P8	LEVEL	5	6	6	8	8	7	7	7	6	7	6	5	5	5	5
	INCLINE	2	4	4	2	2	4	4	6	8	7	8	6	6	2	2
P9	LEVEL	5	6	6	7	7	7	7	6	8	8	9	6	6	6	6
	INCLINE	2	3	3	5	5	4	4	4	3	4	3	2	2	2	2
P10	LEVEL	6	7	7	6	6	7	7	7	6	7	5	6	6	5	5
	INCLINE	3	3	3	2	2	5	5	7	3	5	6	7	7	2	2
P11	LEVEL	7	7	11	7	7	11	7	7	11	7	7	11	7	7	11
	INCLINE	3	3	3	4	4	4	4	3	5	5	6	3	3	3	3
P12	LEVEL	20	20	17	17	15	15	15	12	12	12	10	10	10	7	7
	INCLINE	3	5	5	3	3	4	4	4	3	4	2	5	5	2	2
P13	LEVEL	20	20	20	22	22	22	20	20	20	17	17	17	15	15	15
	INCLINE	2	1	1	2	2	4	4	5	2	2	4	6	6	3	3
P14	LEVEL	20	20	20	20	17	17	15	15	15	10	10	10	7	7	7
	INCLINE	4	2	2	5	5	4	4	2	4	2	4	2	2	4	4
P15	LEVEL	17	17	17	17	20	20	20	20	20	20	15	15	15	15	15
	INCLINE	5	1	1	2	2	3	3	3	2	2	3	4	4	2	2
P16	LEVEL	10	10	12	15	17	20	20	17	15	12	10	10	7	7	7
	INCLINE	4	1	1	2	2	2	2	3	1	2	2	1	1	2	2
P17	LEVEL	11	16	21	21	13	8	8	11	16	21	21	13	8	8	11
	INCLINE	4	3	3	5	5	4	4	2	2	3	4	2	2	3	3

Programme		Setting time / 30 = time for each section														
		1	2	3	4	5	6	7	8	9	10	11	12	13	14	15
P18	LEVEL	8	11	13	18	21	8	11	13	18	21	8	11	13	18	21
	INCLINE	1	1	4	4	4	4	6	1	4	4	6	6	8	8	4
P19	LEVEL	8	21	18	13	11	8	8	21	18	13	11	8	8	21	18
	INCLINE	1	1	2	2	4	4	5	1	2	2	4	4	3	3	3
P20	LEVEL	13	21	21	13	21	21	13	21	21	13	21	21	13	21	21
	INCLINE	1	1	2	2	4	4	5	2	2	4	6	6	3	3	2
P21	LEVEL	13	21	13	21	13	21	13	21	13	21	13	21	13	21	13
	INCLINE	2	2	3	3	4	4	4	3	4	2	5	5	2	2	5
P22	LEVEL	8	8	11	11	16	16	16	18	18	21	23	21	18	18	18
	INCLINE	1	1	2	2	3	3	3	2	2	3	4	4	2	2	3
P23	LEVEL	14	14	23	23	20	20	23	20	23	20	23	23	17	17	14
	INCLINE	1	1	2	2	2	2	3	1	2	2	1	1	2	2	1
P24	LEVEL	17	17	26	26	23	25	23	26	23	27	26	26	20	20	20
	INCLINE	1	1	2	2	3	3	3	2	2	4	6	6	2	2	1
P25	LEVEL	20	20	26	26	25	25	23	26	26	25	26	26	23	23	17
	INCLINE	1	1	3	3	4	4	3	2	2	4	5	5	2	2	1
P26	LEVEL	14	14	26	26	26	26	23	23	26	25	23	23	20	20	17
	INCLINE	1	1	4	4	6	6	2	3	4	2	2	2	2	2	1
P27	LEVEL	14	14	26	26	25	25	20	20	25	20	17	17	20	20	14
	INCLINE	4	4	5	5	6	6	7	9	9	10	10	10	6	6	3
P28	LEVEL	21	21	15	15	24	27	27	26	27	27	24	21	18	18	15
	INCLINE	3	3	5	5	4	4	4	3	4	4	3	3	3	3	2
P29	LEVEL	15	24	27	27	18	21	18	21	24	27	18	18	18	18	15
	INCLINE	3	3	5	5	4	4	2	2	3	4	2	2	3	3	2
P30	LEVEL	18	24	18	18	24	24	21	21	24	18	27	27	18	21	18
	INCLINE	4	4	1	1	3	3	6	7	8	8	7	7	3	3	3
P31	LEVEL	18	18	24	24	27	27	27	28	24	26	24	27	21	21	15
	INCLINE	1	3	6	5	6	5	6	9	9	10	10	10	8	6	4
P32	LEVEL	15	21	24	21	24	24	27	32	27	21	18	15	18	18	21
	INCLINE	3	3	5	5	6	6	7	8	9	10	10	10	7	6	3

Programme		Setting time / 30 = time for each section														
		16	17	18	19	20	21	22	23	24	25	26	27	28	29	30
P18	LEVEL	8	11	13	18	21	8	11	13	18	21	8	11	13	18	21
	INCLINE	4	5	5	10	10	8	8	10	8	10	10	5	5	2	1
P19	LEVEL	13	11	8	8	21	18	13	11	8	8	21	18	13	11	8
	INCLINE	3	1	1	3	3	4	4	3	2	2	4	5	5	2	2
P20	LEVEL	13	21	21	13	21	21	13	21	21	13	21	21	13	21	21
	INCLINE	2	1	1	3	3	4	4	3	2	2	4	5	5	2	2
P21	LEVEL	21	13	21	13	21	13	21	13	21	13	21	13	21	13	21
	INCLINE	5	5	5	4	4	6	6	2	3	4	2	2	2	2	2
P22	LEVEL	18	18	18	21	23	21	18	18	16	16	16	11	11	8	8
	INCLINE	3	5	5	4	4	3	4	3	4	5	6	3	3	3	3
P23	LEVEL	14	17	17	23	23	26	26	26	27	23	25	23	26	20	12
	INCLINE	1	5	5	6	5	6	5	6	9	9	10	10	8	6	3
P24	LEVEL	20	14	14	26	26	26	26	23	23	26	25	26	23	20	20
	INCLINE	1	5	5	4	4	6	6	2	3	4	2	2	2	2	2
P25	LEVEL	17	20	20	14	14	23	26	26	25	26	26	23	20	17	17
	INCLINE	1	3	3	5	5	4	4	4	3	4	4	3	3	3	3
P26	LEVEL	17	14	14	14	23	23	23	20	20	26	20	14	14	17	17
	INCLINE	1	3	3	5	5	6	6	7	8	9	10	10	8	6	2
P27	LEVEL	14	20	20	23	23	26	26	26	26	26	28	26	26	26	17
	INCLINE	3	2	2	5	5	5	5	4	4	6	4	2	2	3	3
P28	LEVEL	15	24	24	18	18	21	21	21	18	21	15	24	24	15	15
	INCLINE	2	2	2	5	5	4	4	2	4	2	4	2	2	1	1
P29	LEVEL	15	21	21	18	18	21	18	24	21	15	15	24	24	18	18
	INCLINE	2	3	3	4	4	4	3	4	2	5	5	2	2	1	1
P30	LEVEL	15	18	18	21	21	18	18	21	18	24	21	15	15	15	12
	INCLINE	3	5	5	3	3	4	4	4	3	4	2	5	5	2	2
P31	LEVEL	15	21	21	24	24	27	27	27	28	28	29	27	27	27	18
	INCLINE	3	2	2	5	5	5	5	4	4	6	4	2	2	3	3
P32	LEVEL	21	18	18	30	30	29	29	30	29	30	29	29	29	18	18
	INCLINE	3	1	1	2	2	4	4	5	2	2	4	6	6	3	3

3.3.4 User-defined programmes

1. Tap on „USER PROGRAM“ in the main menu.
2. Choose one of the four user profiles (U1-U4).

① NOTICE

The chosen user profile will be displayed on the upper border of the screen. The name of the user profile can be changed. To do this, simply tap on the user profile and type in the desired name.

3. Enter your gender, age, weight and the desired training time.
4. Set the desired speed and incline for all the 30 segments.
5. Press START to start the programme.

The resistance level and incline can be adjusted manually during your training.

6. Press the STOP button to pause your training.

The resistance level is set to 0.

- 6.1. Press STOP on the display to end your training and an overview of the collected training data will be displayed.
- 6.2. Press START to continue with your training.

3.3.5 Heart rate-oriented programmes

WARNING

Your training equipment is not a medical device. The heart rate measurement of this equipment may be inaccurate. Various factors can affect the accuracy of the heart rate measurement. The heart rate measurement serves only as a training aid.

There are three different heart rate-oriented programmes. Either choose one of the pre-set target heart rates (60% or 80% of your maximum heart rate) or choose „Target HR“ to set a target heart rate yourself. Your maximum heart rate is calculated depending on your age. We recommend a chest strap for these programmes.

1. Tap on „HRC“ in the main menu.
2. Enter your gender, age, weight and the desired training time.
3. Choose either 60%, 80% or Target HR.
- 3.1. If you have chosen Target HR you will be able to set the target value yourself (between 72-168).
4. Press the START-button to start the programme.
5. Put your hands around the hand pulse sensors or use a chest strap.

NOTICE

In case the console does not receive a signal for 15 seconds the programme will be stopped.

6. Press the STOP-button to pause your training.

The resistance level is set to 0.

- 6.1. Press STOP on the display to end your training and an overview of the collected training data will be displayed.
- 6.2. Press the START-button to continue with your training.

3.3.6 Watt programme

1. Tap "WATT MODE" in the main menu.
2. Set your desired target wattage and training time.

① **NOTICE**

You can set a wattage value between 10 and 350 watts (in increments of 10). The default value is 120.

You can enter the training time between 5 and 999 minutes. The default value is 20 minutes.

3. To start the programme, press START.

The upper left corner of the screen shows the target wattage.

The upper right corner of the screen shows the current wattage.

The target wattage can be adjusted in increments of 5 during the programme by tapping WATT - / WATT +.

The resistance cannot be adjusted manually, but is automatically adjusted according to the target wattage and RPM.

4. To pause the programme, press STOP.
5. To end the programme, press STOP once again.

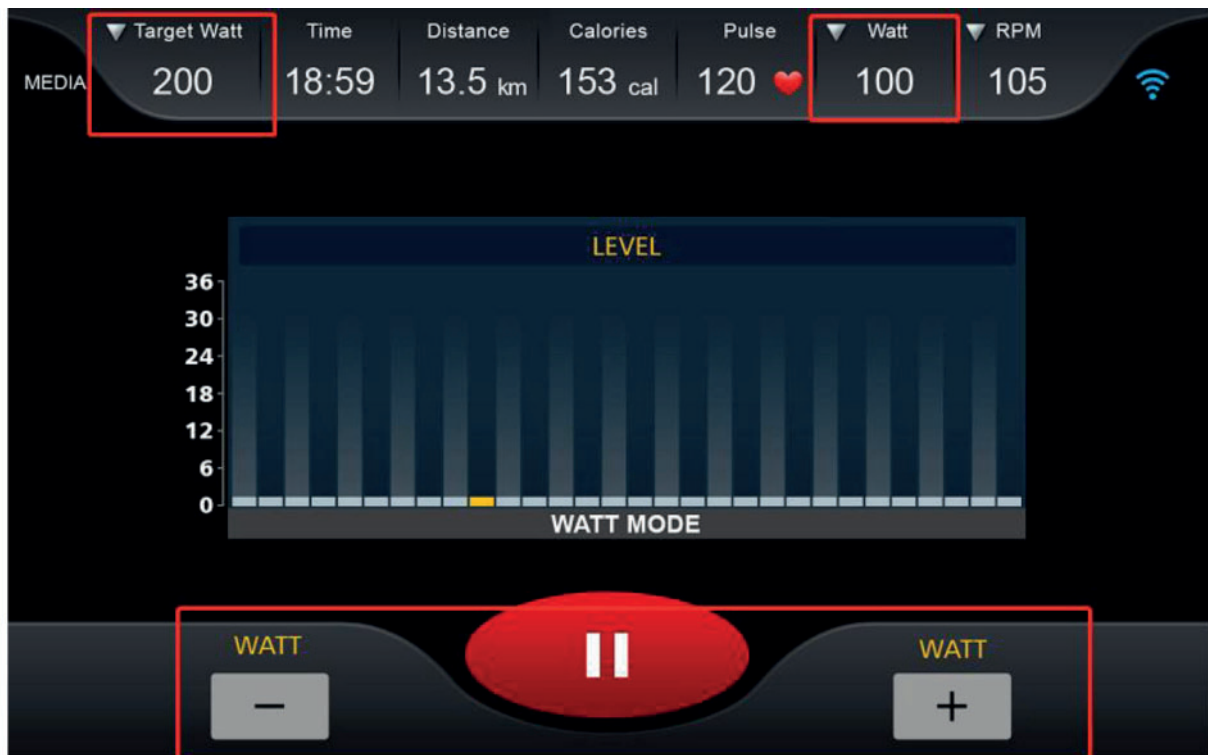

3.4 Fitness Test

The fitness test consists of two phases. One is the warm up phase and the other is the actual fitness test. We recommend a chest strap for this test.

① NOTICE

The RPM must be between 45 - 65 during the test, otherwise an error message will be displayed. If the RPM does not reach the specified amount within 5 seconds, the test will be stopped.

1. Tap on „FITNESS TEST“ in the main menu.
2. Enter your gender, age and weight.
3. Press START to start the fitness test.

The warm up phase will start.

① NOTICE

We recommend to use this phase if you have not done a warm up beforehand. Otherwise the warm up phase can be skipped by tapping on „SKIP WARM UP“.

4. Put your hands around the hand pulse sensors or use a chest strap.

① NOTICE

In case the console does not receive a signal for 15 seconds the programme will be stopped. If your heart rate gets too high the console will display „OVER PULSE“. In this case, please interrupt your test immediately.

Upon completion of the test an overview of the collected training data will be displayed.



3.5 Media

Here you will find many different apps like YouTube, Twitter, Facebook or Instagram.

IMPORTANT NOTE

To ensure the pre-installed apps are working correctly, they must be updated regularly. If needed, the respective app will notify you to do so. To update the app, you need a google account. A google email is sufficient. Just follow the instructions on the screen to perform the update.

Please note: The system is set up only for the pre-installed apps. Do not install any additional apps as their proper functionality can not be guaranteed. The installation of other apps might cause technical issues.

This menu can be opened in two ways:

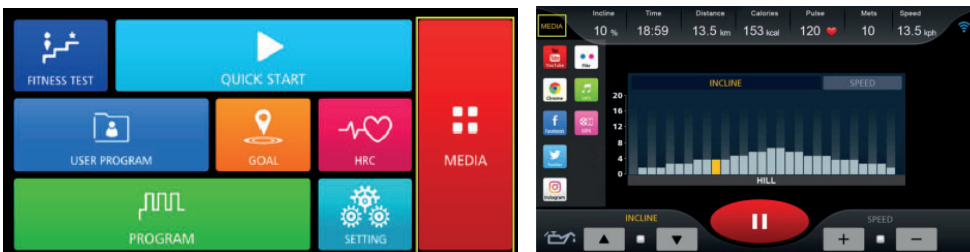

1. Via the main menu by tapping on "MEDIA" or
2. Via the the training interface (in the upper left corner of the screen).

NOTICE

You can show and hide the training interface by tapping on the round icon on the right edge of the screen. To adjust the volume simply tap on the speaker icon.

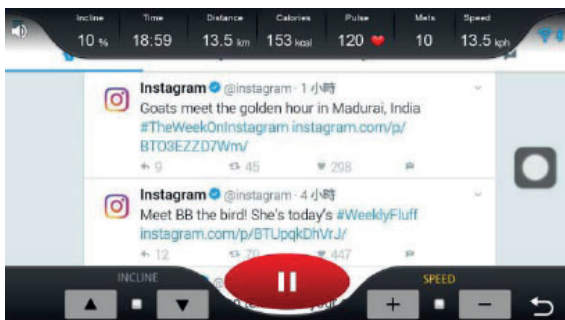

You can transmit music and video data from your USB stick to the console. To do this insert your USB stick into the corresponding slot on the side of the console.

Supported formats:

Music: .wav, .wma, .aac, .ogg, .mp3 und .flac.
Video: .mp4 und .avi.

Settings

Under "SETTINGS" in the main menu, you can make your system settings. This includes: Language, screen brightness and volume.

Wireless Technology: You can connect your mobile device and wireless speakers with the console.

Wireless: Here you can connect the console with the internet.

3.6 Wireless Connection and Fitness Apps

This console is equipped with a wireless connection interface. Please take note that your mobile device needs to be compatible with the wireless connection interface of the treadmill.

To use training apps you will have to activate the wireless connection function on your mobile device (tablet or smart phone) and start the fitness app. Select your fitness equipment. Please follow the instructions given in the app. You will find the name of your fitness equipment on a small sticker on the back of the console.

You will find the fitness apps in the app stores of Google or Apple. There you will find the apps "Kinomap" or "Zwift". Please note that these apps are produced by an external manufacturer. Fitshop does not take any responsibility regarding the availability, functionality or contents of these programmes.

IMPORTANT NOTE

The pre-installed apps are produced and provided by external manufacturers. Changes and availability within these apps might occur. Fitshop does not take any responsibility and can not be held liable for the availability, functionality or contents of these apps. To make sure the pre-installed apps are working correctly, they must be updated regularly. If needed, the respective app will notify you to do so. To update the app, you need a google account. A google email is sufficient. Just follow the instructions on the screen to perform the update.

Please note: The system is set up only for the pre-installed apps. Do not install any additional apps as their proper functionality can not be guaranteed. The installation of other apps might cause technical issues.

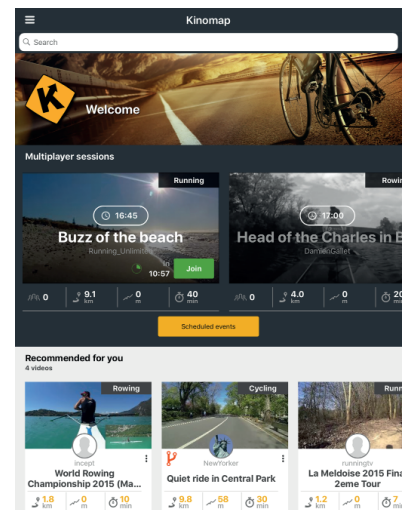
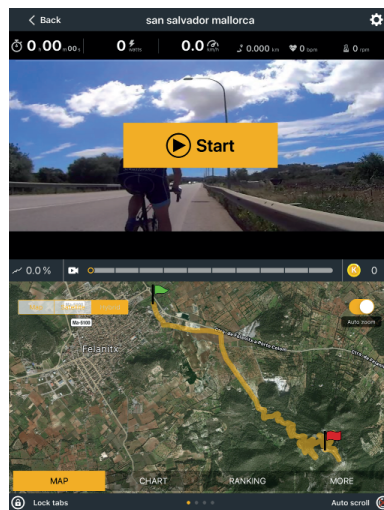
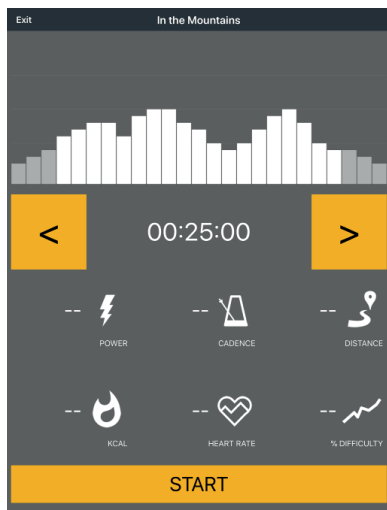

Example: Kinomap

4.1 General Instructions

WARNING

- + The storage location should be chosen so that improper use by third parties or children can be prevented.
- + If your equipment does not have transportation wheels, the equipment must be disassembled before transportation.

▶ ATTENTION

- + Make sure that the equipment is protected from moisture, dust and dirt in the selected storage location. The storage location should be dry and well ventilated and have a constant ambient temperature between 10°C and 35°C.

4.2 Transportation Wheels

▶ ATTENTION

If you want to transport your equipment over particularly sensitive and soft floor coverings, such as parquet, planks or laminate, lay out the transport route with cardboard or similar to avoid possible floor damage.

1. Stand behind the equipment and lift it until the weight is transferred to the transportation wheels. After that, you easily can move the equipment to a new position. For long transport distances the equipment should be disassembled and safely packed.
2. Select the new location by following the instructions in the section 1.4 of this manual.

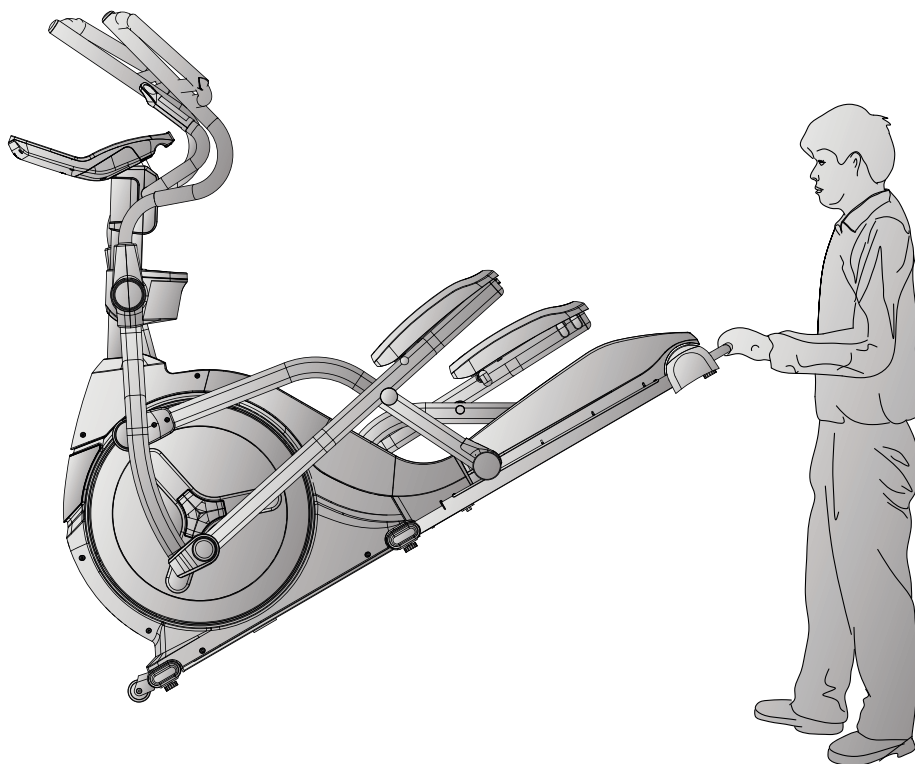

5.1 General Instructions



WARNING

- + Do not make any improper changes to the equipment.



CAUTION

- + Damaged or worn components may affect your safety and the life of the equipment. Therefore, immediately replace damaged or worn components. In such a case, contact the contract partner. The equipment must not be used until it has been repaired. If necessary, use only original spare parts.

▶ ATTENTION

- + In addition to the instructions and recommendations for maintenance and care given here, additional service and/or repair work may be necessary; this must only be carried out by authorised service technicians.

5.2 Faults and Fault Diagnosis

The equipment undergoes regular quality controls during production. Nevertheless, faults or malfunctions may occur. Frequently, individual parts are responsible for these disturbances, an exchange is usually sufficient. Please refer to the following overview for the most common errors and how to correct them. If the equipment still does not function properly, contact your contract partner.

Fault	Cause	Solution
Drive disks wobble/ make noises	Drive disk loose	Tighten nut (pay attention to left-hand / right-hand thread)
Display is blank/is not working	Loose cable connections	Check cable connections
Equipment wobbles	Equipment is not level	Align the feet
Creaking noises on the stepping area	Loose screws on stepping area	Tighten the screws on the stepping area
Creaking noises	Screw connections loosened or too tight	Check screw connections
Squeaking noises on the guide rails	Guide rails or rollers dirty or guide rails dry	Clean the guide rails and then lubricate them with a suitable lubricant

No pulse display	<ul style="list-style-type: none"> + Sources of interference in the room + unsuitable chest strap + Wrong position of chest strap + Chest strap defective or battery empty + Pulse display defective 	<ul style="list-style-type: none"> + Eliminate sources of interference (e.g. mobile phone, WLAN, lawn mower and vacuum cleaner robot, etc. ...) + Use a suitable chest strap (see "RECOMMENDED ACCESSORIES"). + Reposition chest strap and/or moisten electrodes + Changing batteries + Check if pulse display by hand pulse possible
------------------	---	--

5.3 Error Codes and Troubleshooting

The electronics of the equipment continuously carries out tests. In case of deviations, an error code appears on the display and normal operation is stopped for your safety.

Please contact the contract partner for technical support.

5.4 Maintenance and Inspection Calendar

To avoid damage from body sweat, the equipment must be cleaned with a damp towel (no solvents!) after each training session.

The following routine tasks must be performed at the specified intervals:

Part	Weekly	Monthly	Quarterly
Display console	C	I	
Slide rails*		C	
Lubrication of slide rails and moving parts*			I
Plastic covers	C	I	
Screws and cable connections		I	
Legend: C = clean; I = inspect			

*Make sure to always clean the slide rails and moving parts before re-lubricating.

By scanning the QR-code with the camera function or QR-code scanner app of your smartphone/tablet, a video on general maintenance of a crosstrainer opens on YouTube. The video serves to illustrate the maintenance points described in this manual.

Please note that the video may not be available in your language or with appropriate subtitles.

If you cannot scan QR-codes, you can access all Fitshop videos on YouTube by first opening YouTube and entering "Fitshop" in the search field.



6 DISPOSAL

At the end of its operational life, this equipment cannot be disposed of in normal household waste. Instead, it must be disposed of via an electricals recycling centre. Further information can be obtained from your local authority's recycling service.



The materials can be recycled as per their symbols. Through the reuse, recycling of materials or other forms of recovery of old equipment, you make an important contribution to the protection of the environment.

7 RECOMMENDED ACCESSORIES

To make your training experience even more efficient and pleasant, we recommend that you add suiting accessories to your fitness equipment. For elliptical cross trainers this could for example be a **floor mat**, which makes your fitness equipment stand more securely and also protects the floor from sweat or **silicone spray** to keep moving parts in good shape.

If you have purchased a fitness machine with pulse training and want to train your heart rate, we strongly recommend that you use a compatible **chest strap**, as this ensures optimum transmission of the heart rate.

Our range of accessories offers the highest quality and makes training even better. If you would like to find out more about compatible accessories, please go to the detail page of the product in our webshop (the easiest way is to enter the article number in the search field above) and go to the recommended accessories on this page. Alternatively, you can use the QR-code provided. Of course, you can also contact our customer service: by telephone, e-mail, in one of our branches or via our social media channels. We will be happy to advise you!



floor mat



chest strap



chest strap contact gel



silicone spray



towels

8.1 Serial Number and Model Name

In order to provide you with the best possible service, please have the model name, article number, serial number, exploded drawing and parts list ready. The corresponding contact options can be found in chapter 10 of this operating manual.

NOTICE

The serial number of your equipment is unique. It's located on a white sticker. The exact position of this sticker is shown in the following illustration.

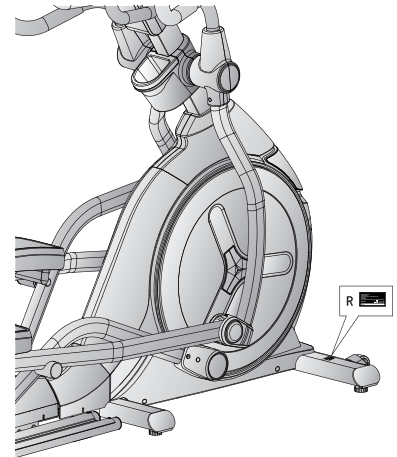

Enter the serial number in the appropriate field.

Serial number:

Brand / Category:

Model Name:

Article Number:

8.2 Parts List

No.	Name	Supplier Part No.	Specification	Qty.
1	main frame	747S3-3-1000-J0		1
2	front stabilizer	747S0-3-2100-J1		1
3	hex bolt	50108-5-0120-F5	M8*1.25*120L	2
4	spring washer	55108-2-1520-FA	D15.4xD8.2x2T	16
5	hex bolt	50108-5-0070-F4	M8*1.25*70L	2
6	allen bolt	54008-5-0020-F0	M8*1.25*20L	4
7	flat washer	55108-1-1612-FA	D16*D8.5*1.2T	4
8	allen bolt	50308-5-0050-F3	M8*1.25*50L	6
9	curved washer	55108-3-2215-FA	D22xD8.5x1.5T	6
10	anti-loose nut	55208-1-2008-FA	M8*1.25*8T	8
11	handlebar post welding	747A2-3-2000-J1		1
12L	supporting tube for left movable handlebar	747S0-3-3710-J0		1
12R	supporting tube for right movable handlebar	747S0-3-3711-J0		1
13L	left handlebar welding set	747S0-3-2430-J1		1
13R	right handlebar welding set	747S0-3-2450-J1		1
14L	left pedal bottom tube welding set	747S0-3-3810-J2		1
14R	right pedal bottom tube welding set	747S0-3-3811-J2		1
15L	bracket for left pedal	747S0-3-6000-J3		1
15R	bracket for right pedal	747S0-3-6025-J3		1
16	pedal bottom bracket welding set	747S0-3-3804-J3		2
17	foot tube sealing piece	747S0-6-2108-J0	104*63*4T	4
18	crank welding set	747S0-3-2700-J3		2
19	computer	747S3-6-2501-B0	AC00512	1
20	sliding beam guiding plate	747A2-6-5171-00	126.9*720L*2.3T	2
21	adjustable wheel	26000-6-1095-B0	D38*M10*1.5	6
22	allen nut	55210-2-2008-NA	M10*1.5*8T	6
23	fixing plate for idle wheel	747S0-3-1600-00		1
24	electric magnetic system	747S0-3-3102-01	D265*153*50	1
25	crank axle welding set	747S0-3-2903-01		1
26	pulley Wheel	58008-6-1036-D0	D350*29.9*3T	1
27	multi-groove Belt	58004-6-1110-00	520 PJ8	1
28	C key	75000-6-3107-01	8*7*20L	2

29L	left chain	747S0-6-4501-B0	734.4*878.2*98.1	1
29R	right chain	747S0-6-4502-B0	734*878.2*105.2	1
30L	left front chain cover	747S0-6-4529-B1	459.7*225.5*87.2	1
30R	right front chain cover	747S0-6-4530-B1	459.7*225.5*93.8	1
31	front decorative cover	747S0-6-4523-B20	168.9*175.2*170.8	1
32	upper decorative cover	747S0-6-4520-B0	639*313.7*176.5	1
33	rear decorative cover	747A2-6-4521-B0	217.5*177.1*144.6	1
34	round chain	747S0-6-4506-B0	D632.9*36.7	2
35	side cap	747S0-6-4582-C0	148*130.3*16.1	2
36	cover for rear stabilizer	747S0-6-4542-B1	566.9*109.3*144.3	1
37	inside cover for rear stabilizer	747S0-6-4543-B0	503.5*59*44.6	1
38	water bottle holder(front)(black)	747S0-6-2091-B0	195*159*71.8	1
39	water bottle holder(rear)(black)	747S0-6-2092-B0	195*167.1*159.4	1
40	water bottle holder	747S0-6-2074-B0	113*138.3*120.5	1
41	upper handle pulse cover	747S0-6-2517-B0	184.5*20.8*50	2
42	lower handle pulse cover	747S0-6-2518-B0	184.5*35.2*50	2
43L	left dipped foam	58015-6-1386-B0	D38*4T	1
43R	right dipped foam	58015-6-1387-B0	D38*4T	1
44	pedal	58029-6-1147-B0	434.2*210.7*84	2
45	pedal pad	75000-6-3896-B0	379*168.5*5T	2
46	bearing	58006-6-1057-00	#6205ZZ,NBK	2
47	allen bolt	54010-8-0065-F6	M10*1.5*65L	2
48	hex nut	55210-A-2008-FA	M10*1.5*8T	4
49	spacer	75000-6-2781-01	D29.5*D25.2*9T	1
50	hex bolt	50108-2-0020-U0	M8x1.25x20	8
51	flat washer	55108-1-2520-FA	D25*D8.5*2T	16
52	buffer	739S0-6-1081-B0	D27*D8.2*2.5T	6
53	sleeve	747S0-6-2707-00	D30*D25.2*45L	1
54	fixing nut	75000-6-2807-N0	M25*1.5*32*6T	2
55	allen screw	54006-5-0010-F0	M6*1.0*10L	2
56	flat washer	55106-1-2820-FA	D28*D6.5*2T	2
57	allen screw	54006-5-0015-D0	M6*1.0*15L	4
58	flat washer	55106-1-1310-NA	D13*D6.5*1.0T	4
59	spring washer	55106-2-1013-NA	D10.5*D6.1*1.3T	4
60	movable axle	747S0-6-3771-00	D25*180.5L	2

61	moving wheel	73800-6-3886-B3	D70*43	4
62	bearing	58006-6-1032-00	6002 ZZ	8
63	moving wheel cover	74750-6-3897-B0	162*136.2*87	2
64	front handlebar protective cover(black)	74750-6-3780-B0	240.5*127.8*59	2
65	rear handlebar protective cover(black)	74750-6-3781-B0	240.5*127.8*50	2
66	bearing	58006-6-1017-00	#6004ZZ	12
67	sleeve(2)	74750-6-2788-00	D25.4*D20.2*44L	2
68L	front foot cover (left)(black)	74750-6-3775-B0	152.3*91.1*46.7	2
68R	front foot cover (right)(black)	74750-6-3776-B0	152.3*91.1*60	2
69	bushing	58002-6-1028-UC2	D29*D12.1*9T	4
70	liner	74750-6-2973-00	D25.4*D20.2*26L	2
71	front pedal axle cover	74750-6-3880-B0	182.4*95.7*67.6	2
72	allen screw	50412-8-0070-F4	M12*1.75*70L	4
73	flat washer	55112-1-2425-FA	D24*D13.5*2.5T	8
74	anti-loose nut	55212-1-2012-FA	M12*1.75*12T	4
75	bearing	58006-6-1031-00	#2203-2RS	2
76	c-clip	55540-3-0018-D0	S-40(1.8T)	2
77	bushing	58002-6-1092-01	D19*D17*D12*20T	4
78	sleeve	74750-6-5202-01	D25.4*D20.2*31L	2
79	cross screw	52606-2-0015-N0	M6*1*15L	8
80	cross screw	52842-2-0015-F0	ST4.2*15L	8
81	c-clip	55517-1-0010-00	S-17(1T)	1
82	waved washer	55117-5-2203--DA	D17*D22*0.3T	3
83	bearing	58006-6-1026-01	6203-2RS	2
84	anti-loose nut	55208-1-2008-NA	M8*1.25*8T	1
85	flat washer	55108-1-2830-NA	D28*D8.5*3T	1
86	hex nut	55208-2-2006-NA	M8*1.25*6T	1
87	hex bolt	50108-5-0030-C4	M8*1.25*30L	1
88	plastic washer	55110-1-5010-BF	D50*D10*1.0T	1
89	anti-loose nut	55206-1-2006-CA	M6x1.0x6T	1
90	hex bolt	50106-2-0075-N0	M6*75L	1
91	fixing plate	815G0-6-1673-N0	20*27*4T	2
92	hex bolt	50106-5-0015-C0	M6x1.0x15L	1
93	hex nut	55206-2-2005-NA	M6*1*5T	3
94	hex bolt	50108-5-0020-C0	M8x1.25x20L	4

95	anti-loose nut	55208-1-2008-CA	M8*1.25*8T	4
96	cross screw	52842-2-0015-F0	ST4.2*15L	39
97	cross screw	52605-5-0012-F0	M5*0.8*12L	47
98	computer bracket(front)	74750-6-2592-B0	196.4*109.5*49.1	1
99	computer bracket(rear)	74750-6-2593-B0	196.3*109.5*96.4	1
100	upper computer cable	73455-6-2572-00	300L	1
101	middle computer cable	73455-6-2587-00	1000L	1
102	lower computer cable	74753-6-2573-00	800L	1
103	system connect cable	82050-6-3177-00	350L	1
104	sensor cable	815G0-6-2576-00	450L	1
105	round magnet	742G0-6-2574-00		1
106	quick key upper cable(1)	73455-6-2542-00	400L	1
107	quick key upper cable(2)	73455-6-2539-00	400L	1
108	quick key lower cable(1)	73455-6-2544-00	850L	1
109	quick key lower cable(1)	73455-6-2536-00	850L	1
111	control board	74753-6-2597-00	PA-AE00530	1
112	switching mode power supplier	261D8-6-2411-00		1
113	socket	26100-6-2413-00		1
114	live wire (1)	26200-6-1789-00	220L	1
115	neutral wire(2)	26200-6-1792-00	220L	1
116	grounding cable(2)	73450-6-3486-00	200L	3
117	electric cable	26100-6-1775-02	1700L	1
118	computer back cover	74750-6-2529-B0	337.6*225.5*58.4	1
119	allen bolt	54008-5-0025-F0	M8*1.25*25L	4
120	allen bolt	50308-5-0040-F3	M8*1.25*40L	2
121	transporting wheel	84302-6-2175-00	D70.5*23	2
122	bushing	58002-6-1099-00	D22.2*D8.2*7T	4
123	cross screw	54203-2-0030-F0	M3*0.5*30L	4
124	cross screw	54203-2-0012-F0	M3*0.5*12L	2
125	oval square	55315-3-3060-B8	30*60*15	2
126	buffer	74750-6-1081-B0	D21*D8.2*2.5T	4
127	spacer	74750-6-3892-00	D19*D15.2*25.5L	4
128	cross screw	52606-2-0015-F0	M6*1*15L	8
129	oval square	55328-3-2550-B1	25*50*28L	4
130	round cap	55350-1-0015-B8	D50.8*15	2

131	flat washer	55105-1-1510-DA	D15*D5.2*1.0T	4
132	flat washer	55126-1-3420-FA	D34*D26*2T	1
133	flat washer	55108-1-1812-FA	D18*D8.5*1.2T	4
143	rear cover	747A2-6-4514-B1	766.7*169.6*144.3	1
144	pin	71600-6-4586-60	D6*26.5*7.7	2
145	cross screw	52804-2-0012-F0	ST4*1.41*12L	3
146	rear stabilizer welding set	747A2-3-2112-J2		1
147	hex bolt	50108-5-0055-F3	M8*1.25*55L	4
148	hex bolt	50108-5-0035-F3	M8*1.25*35L	4
149	buffer	55305-5-3535-B9	35*35*25T(M8*1.25)	2
150	buffer	708S0-6-1081-B0	20*90*1.7T	2
153	bushing	58002-6-1051-B0	D19.15x(D25.6x32) xL(17+3)	2+4
154	allen bolt	50308-5-0020-UF0	M8*1.25*20L	4
155	slide beam welding set	747A2-3-5100-J4		1
156	ball cap	55338-1-0031-B8	D38*31L	4
157	square cap	55312-2-2550-B8	25*50*12L	2
158	incline	747A2-6-5172-00	JS17-B	1
159	hex bolt	50110-2-0145-F6	M10*1.5*145L	1
160	hex bolt	50110-2-0075-F3	M10*1.5*75L	1+1
161	flat washer	55110-1-2020-FA	D20*D11*2T	2+1
162	anti-loose nut	55210-1-2010-FA	M10*1.5*10T	2+1
163	bolt cover	19100-6-3172-B0	D35*8	3
164	circumgyrate axle	747A2-6-2751-00	D19*490.5L	1
165	incline control cable(1)	747S3-6-3481-00	500L	1
166	incline control cable(2)	747S3-6-3482-00	1200L	1
167	VR control cable	747S3-6-3475-00	1200L	1
168	handpulse upper cable	734S5-6-2585-00		1
171	neutral wire	747S3-6-3479-00	300L	1
172	live wire	747S3-6-3480-00	300L	1
176	computer Fixing Plate	747A2-3-2725-J2		1
/	allen spanner	58030-6-1031-D1	M6	1
/	open sanner	58030-6-1039-C1	188*6.5T	1
/	spanner	58030-6-1005-N2	121*D6	1
	allen spanner	58030-6-1033-N0	M10	1

8.3 Exploded Drawing

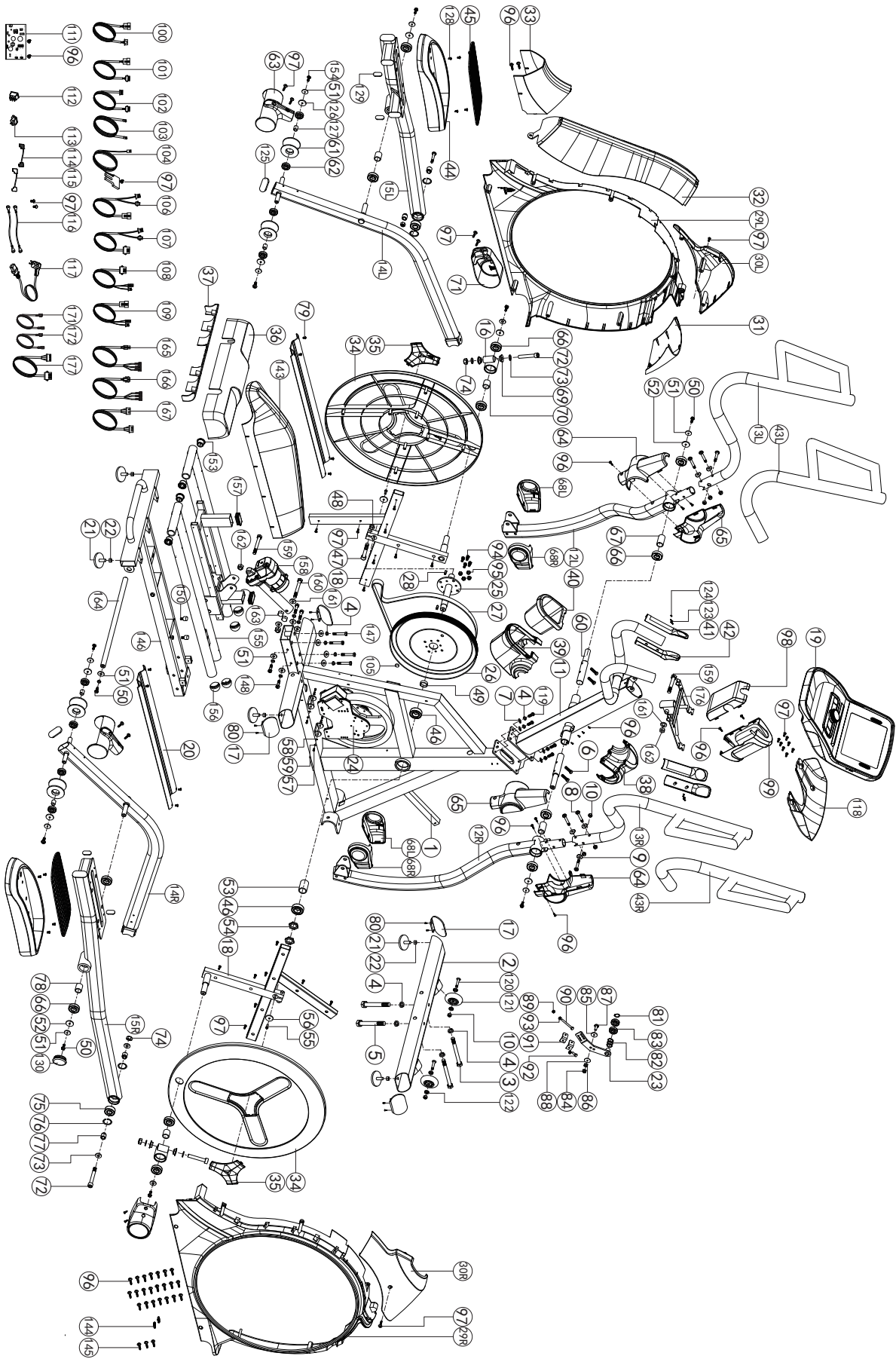

Products from TAURUS® are subject to strict quality control. However, if a fitness equipment purchased from us does not work perfectly, we take it very seriously and ask you to contact our customer service as indicated. We are happy to help you by phone via our service hotline.

Error Descriptions

Your fitness equipment is developed for long-term, high-quality training. However, should a problem arise, please first read the operating instructions. For further assistance, please contact your contract partner or call our service hotline. To ensure your problem is solved as quickly as possible, please describe the defect as exactly as possible.

In addition to the statutory warranty, we provide a warranty for every fitness equipment purchased from us according to the following provisions.

Your statutory rights are not affected.

Warranty

The warranty is the first/original buyer and/or any person who received a newly purchased product as a gift from the original buyer.

Warranty period

The warranty periods, shown on our web shop, begin on delivery of the fitness equipment. The respective warranty periods for your equipment can be found on its product website.

Repair Costs

According to our choice, there will either be a repair, a replacement of individual damaged parts or a complete replacement. Spare parts, that have to be mounted while assembling the equipment, have to be replaced by the warranty holder personally and are not a part of repair. After the expiration of the warranty period, the responsibility for parts costs, repair costs, installation costs and delivery costs lies with the warranty holder.

The terms of use are defined as follows:

- + Home use: solely for private use in private households up to 3 hours per day
- + Semi-professional use: up to 6 hours per day (e. g. rehabilitation centres, hotels, clubs, company gyms)
- + Professional use: more than 6 hours per day (e. g. commercial gyms)

Warranty Service

Within the warranty period, equipment which develops faults as a result of material or manufacturing defects, will be repaired or replaced at our discretion. Ownership of equipment or parts of equipment which have been replaced is transferred to us. The warranty period is not extended nor does a new warranty period begin following repair or replacement under the warranty.

Warranty Conditions

For the warranty to be valid, the following steps must be taken:

Please contact our customer service by email or phone. If the product under warranty has to be sent in for repair, the seller bears costs. After expiry of the warranty, the buyer bears the costs of transport and insurance. If the fault is covered by our warranty, you will receive a new or repaired equipment in return.

Warranty claims are invalid in case of damage resulting from:

- + misuse or improper handling
- + environmental influences (moisture, heat, electrical surge, dust, etc.)
- + failure to follow the current safety measures for the equipment
- + failure to follow the operating instructions
- + use of force (e. g. hitting, kicking, falling)
- + interventions which were not carried out by one of our authorized service centres
- + unauthorised repair attempts

Proof of Purchase and Serial Number

Please make sure that you are able to provide the appropriate receipt when claiming on your warranty. So that we can clearly identify the model of your equipment, and for the purposes of our quality control, you will need to give the serial number of your equipment, when contacting the service team. Where possible please have your serial number and your customer number ready when you call our service hotline. It will help us to deal with your request swiftly.

If you cannot find the serial number on your fitness equipment, our service team is at your disposal to offer further information.







































Service outside of the Warranty Period

We are also happy to issue an individual cost estimate if there is a problem with your fitness equipment after the warranty has expired, or in cases which do not fall under the terms of the warranty, e. g. normal wear and tear. Please contact our customer service team to find a quick and cost-effective solution to your problem. In such a case you will be responsible for the delivery costs.

Communication

Many problems can be solved just by speaking to us as your specialist supplier. We know how important it is to you as a user of the fitness equipment to have problems solved quickly and simply, so you can enjoy working out with minimal interruption. For that reason, we also want to resolve your queries quickly and in a straightforward manner. Thus, please always keep your customer number and the serial number of the faulty equipment handy.

10 CONTACT

DE	DK	UK
<p>TECHNIK</p> <p> +49 4621 4210-900</p> <p> +49 4621 4210-698</p> <p> technik@fitshop.de</p> <p> Öffnungszeiten entnehmen Sie unserer Homepage.</p> <p>SERVICE</p> <p> 0800 20 20277 (kostenlos)</p> <p> 04621 4210 - 0</p> <p> info@fitshop.de</p> <p> Öffnungszeiten entnehmen Sie unserer Homepage: https://stg.fit/statita</p>	<p>TEKNIK OG SERVICE</p> <p> 80 90 16 50</p> <p>+49 4621 4210-945</p> <p> info@fitshop.dk</p> <p> Åbningstider kan findes på hjemmesiden: https://stg.fit/statit7</p> <p>FR</p> <p>TECHNIQUE & SERVICE</p> <p> +33 (0) 189 530984</p> <p>+49 4621 42 10 933</p> <p> info@fitshop.fr</p> <p> Vous trouverez les heures d'ouverture sur notre site Internet: https://stg.fit/statit4</p>	<p>CUSTOMER SUPPORT</p> <p> 00800 2020 2772</p> <p>+494621 4210 944</p> <p> info@fitshop.co.uk</p> <p> You can find the opening hours on our homepage: https://stg.fit/statitc</p> <p>BE</p> <p>TECHNIQUE & SERVICE</p> <p> 02 732 46 77</p> <p>+49 4621 4210 933</p> <p> info@fitshop.be</p> <p> Vous trouverez les heures d'ouverture sur notre site Internet: https://stg.fit/statit8</p>
ES	NL	INT
<p>TECNOLOGÍA Y SERVICIOS</p> <p> 911 238 029</p> <p> info@fitshop.es</p> <p> Consulta nuestro horario de apertura en la página web: https://stg.fit/statit5</p>	<p>TECHNISCHE DIENST & SERVICE</p> <p> +31 172 619961</p> <p> service@fitshop.nl</p> <p> De openingstijden vindt u op onze homepage: https://stg.fit/statit3</p>	<p>TECHNICAL SUPPORT & SERVICE</p> <p> +49 4621 4210-944</p> <p> service-int@fitshop.de</p> <p> You can find the opening hours on our homepage: https://stg.fit/statita</p>
PL	AT	CH
<p>DZIAŁ TECHNICZNY I SERWIS</p> <p> 22 307 43 21</p> <p>+49 4621 42 10-948</p> <p> info@fitshop.pl</p> <p> Godziny otwarcia można znaleźć na stronie głównej: https://stg.fit/statit6</p>	<p>TECHNIK & SERVICE</p> <p> 0800 20 20277 (Freecall)</p> <p>+49 4621 42 10-0</p> <p> info@fitshop.at</p> <p> Öffnungszeiten entnehmen Sie unserer Homepage: https://stg.fit/statitb</p>	<p>TECHNIK & SERVICE</p> <p> 0800 202 027</p> <p>+49 4621 42 10-0</p> <p> info@fitshop.ch</p> <p> Öffnungszeiten entnehmen Sie unserer Homepage: https://stg.fit/statit9</p>

Please find a detailed overview including address and opening hours for all stores of the Fitshop Group in Germany and abroad on the following website:

www.Fitshop.com/en/stores

WE LIVE FITNESS

WEBSHOP AND SOCIAL MEDIA

Fitshop is Europe's largest specialist store for home fitness equipment with currently over 70 stores and one of the world's most renowned online mail order companies for fitness equipment. Private customers order via the 25 web shops in the respective national language or have their desired equipment assembled on site. In addition, the company supplies fitness studios, hotels, sports clubs, companies and physio practices with professional equipment for endurance and strength training.

Fitshop offers a wide range of fitness equipment from renowned manufacturers, high-quality in-house developments and comprehensive services, such as a build-up service and sports scientific advice before and after the purchase. The company employs numerous sports scientists, fitness trainers and competitive athletes.

Visit us also on our social media platforms or our blog!

	www.fitshop.co.uk www.fitshop.de/blog
---	--

	www.facebook.com/fitshop.co.uk
---	--

	www.instagram.com/fitshop_uk
--	--

	www.youtube.com/@fitshop_uk
---	--

TAURUS

 cardiostrong

BODYCRAFT

 cardiojump

 **DUKEFITNESS**

DARWIN

Notes

Notes

TAURUS®

Elliptical Trainer FX9.9 Touch