

TAURUS®

Assembly Instructions

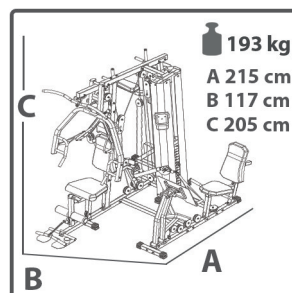
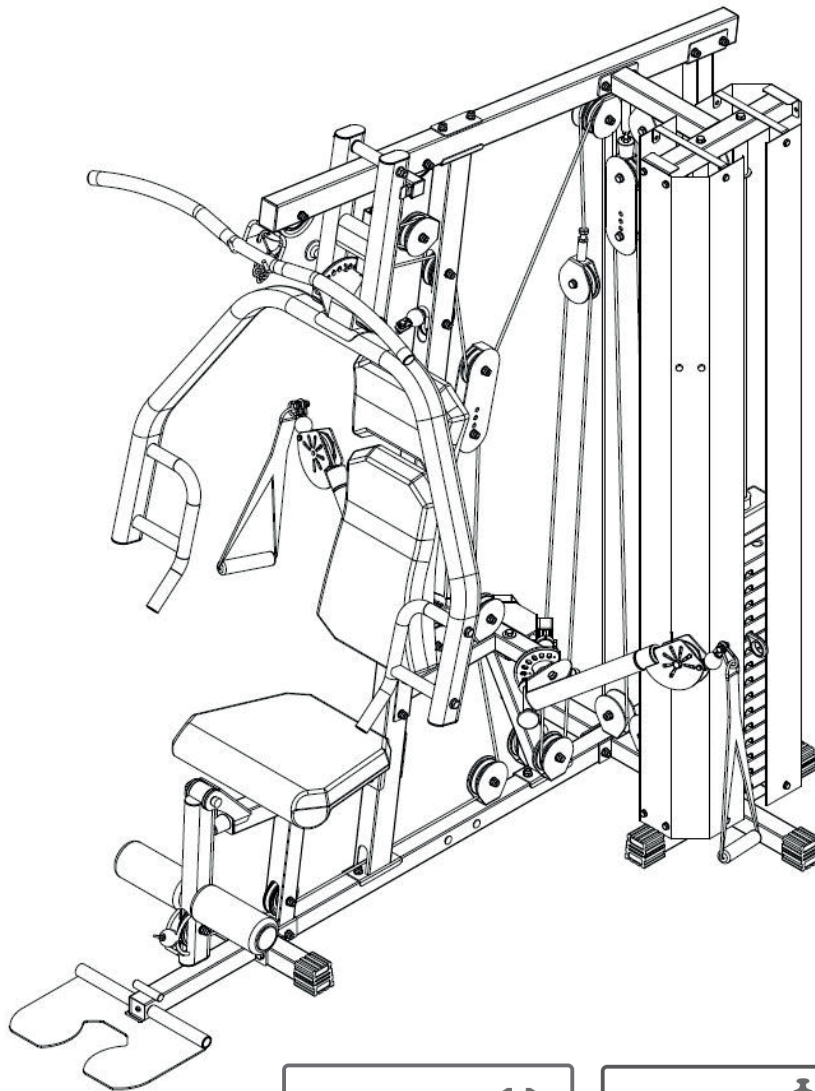

TFWS3.02.01

Content

1	GENERAL INFORMATION	7
1.1	Technical Data	7
1.2	Personal Safety	8
1.3	Set-Up Place	9
2	ASSEMBLY	10
2.1	General Instructions	10
2.2	Scope of Delivery	11
2.3	Assembly	14
2.4	Cable Installation Overview	34
3	STORAGE AND TRANSPORT	35
3.1	General Instructions	35
4	TROUBLESHOOTING, CARE AND MAINTENANCE	36
4.1	General Instructions	36
4.2	Faults and Fault Diagnosis	36
4.3	Maintenance and Inspection Calendar	37
5	DISPOSAL	37
6	RECOMMENDED ACCESSORIES	38
7	ORDERING SPARE PARTS	39
7.1	Serial Number and Model Name	39
7.2	Parts List	40
7.3	Exploded Drawing	45
8	WARRANTY	46
9	CONTACT	48

Dear customer,

Thank you for choosing a high-quality equipment of the brand Taurus®. Taurus® offers sports and fitness equipment for the sophisticated home sport and the equipment of fitness studios and business customers. With Taurus® fitness equipment, the focus is on what sport is all about: maximum performance! Therefore, the equipment is developed in close consultation with athletes and sports scientists. Because athletes know best what makes perfect fitness equipment.

Further information can be found at www.sport-tiedje.com.

Intended Use

The equipment may only be used for its intended purpose.

The equipment is only suitable for home use. The equipment is not suitable for semi-professional (e.g. hospitals, associations, hotels, schools, etc.) and commercial or professional use (e.g. fitness studios).

Legal Notice

Sport-Tiedje GmbH
Europe's No. 1 for home fitness

International Headquarters
Flensburger Straße 55
24837 Schleswig
Germany

Management:
Christian Grau
Sebastian Campmann
Dr. Bernhard Schenkel
No. HRB 1000 SL
Local Court Flensburg
European VAT Number: DE813211547

Disclaimer



©2010 Taurus® is a registered brand of the company SportTiedje GmbH. All rights reserved. Any use of this trademark without the explicit written permission of Sport-Tiedje is prohibited.

Product and manual are subject to change. Technical data can be changed without advance notice.

ABOUT THIS MANUAL

Please carefully read the entire manual before installation and first use. The manual will help you to quickly set up the system and explains how to safely use it. Make sure that all persons exercising with the equipment (especially children and persons with physical, sensory, mental or motor disabilities) are informed about this manual and its contents in advance. In case of doubt, responsible persons must supervise the use of the equipment.



This equipment has been manufactured according to the latest safety knowledge. As far as possible, potential safety hazards which could cause injury have been eliminated. Make sure to carefully follow the instructions and that all parts are securely in place. If required, read through the instructions again to correct any mistakes.

Please pay close attention to the safety and maintenance instructions given here. The contract partner cannot be held liable for damage to health, accidents or damage to the equipment when it is not used in accordance with these instructions.

The following safety instructions may appear in this manual:

► **ATTENTION**

This notice indicates potentially hazardous situations which, if not avoided, may result in property damage.

⚠ **CAUTION**

This notice indicates potentially hazardous situations which, if not avoided, may result in slight or minor injuries!

⚠ **WARNING**

This notice indicates potentially hazardous situations which, if not avoided, may result in death or serious injuries!

⚠ **DANGER**

This notice indicates potentially hazardous situations which, if not avoided, will result in death or serious injuries!

ⓘ **NOTICE**

This notice indicates further useful information.

Retain these instructions in a safe place for future reference, maintenance or when ordering replacement parts.

1.1 Technical Data

Weight and dimensions:

Article weight (gross, inc. packaging): 398,5 kg

Article weight (net, without packaging): 193 kg

Packaging dimensions (LxWxH):

No. 1 approx. 194 cm x 32 cm x 24 cm

No. 2 approx. 163 cm x 32 cm x 24 cm

No. 3 approx. 120 cm x 59 cm x 24 cm

No. 4 approx. 111 cm x 101 cm x 18 cm

No. 5 approx. 40 cm x 20 cm x 23 cm

No. 6 approx. 40 cm x 20 cm x 23 cm

No. 7 approx. 40 cm x 20 cm x 31 cm

Set-up dimensions (LxWxH): approx. 215 cm x 117 cm x 205 cm

Maximum user weight: 150 kg

1.2 Personal Safety

DANGER

- + Before you start using the equipment, you should consult your physician that this type of exercise is suitable for you from a health perspective. Particularly affected are persons who: have a hereditary disposition to high blood pressure or heart disease, are over the age of 45, smoke, have high cholesterol values, are overweight and/or have not exercised regularly in the past year. If you are under medical treatment that affects your heart rate, medical advice is absolutely essential.
- + Note that excessive training can seriously endanger your health. Please also note that heart rate monitoring systems can be inaccurate. If you notice any signs of weakness, nausea, dizziness, pain, shortness of breath, or other abnormal symptoms, stop exercising immediately and seek advice from your doctor if necessary.

WARNING

- + This equipment may not be used by children under the age of 14.
- + Children should not be allowed unsupervised access to the equipment.
- + Persons with disabilities must have a medical license and must be under strict observation when using the equipment.
- + The equipment is strictly for use by one person at a time.
- + If your equipment provides a safety key, the clip of the safety key must be attached to your clothing before starting your training. In the event of a fall, the EMERGENCY STOP of the equipment can be initiated.
- + Keep your hands, feet and other body parts, hair, clothing, jewellery and other objects well clear of moving parts.
- + During use, wear suitable sports clothing rather than loose or baggy clothing. When wearing sports shoes, make sure they have suitable soles, preferably made of rubber or other non-slip materials. Shoes with heels, leather soles, studs or spikes are unsuitable. Never exercise barefoot.

CAUTION

- + If your equipment needs to be connected to the power supply with a mains cable, make sure that the cable is not a potential tripping hazard.
- + Make sure that nobody is within the range of motion of the equipment during training so as not to endanger you or other persons.

ATTENTION

- + Do not insert any objects of any kind into the openings of the device.

1.3 Set-Up Place



WARNING

- + Do not place the equipment in main corridors or escape routes.



CAUTION

- + The training room should be well ventilated during training and not be exposed to any draughts.
- + Choose the place in which to set up the equipment such that there is enough free space/clearance to the front, the rear and to the sides of the equipment.
- + The set-up and mounting surface of the equipment should be flat, loadable and solid.

▶ ATTENTION

- + The device may only be used in one building, in sufficiently tempered and dry rooms (ambient temperatures between 10°C and 35°C). The equipment should not be used outdoors or in rooms with high humidity (over 70%) like swimming pools.
- + A floor protective mat/equipment underlay can help to protect high-quality floor coverings (parquet, laminate, cork, carpets) from dents and sweat and can help to level out slight unevenness.

2.1 General Instructions



DANGER

- + Do not leave any tools, packaging materials such as foils or small parts lying around, as otherwise there is a danger of suffocation for children. Keep children away from the equipment during assembly.



WARNING

- + Pay attention to the instructions attached to the equipment in order to reduce the risk of injuries.



CAUTION

- + Do not open the packaging when it is lying on its side.
- + Ensure to have sufficient room for movement in each direction during assembly.
- + The assembly of the equipment must be carried out by at least two adults. If in doubt, seek the help of a third technically skilled person.



ATTENTION

- + To prevent damage to the equipment and the floor, assemble the equipment on a mat or packaging board.



NOTICE









- + In order to make the assembly as simple as possible, some screws and nuts to be used can already be pre-assembled.
- + Ideally, assemble the equipment at its later set-up place.

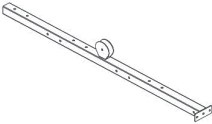
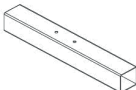
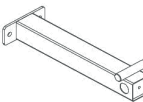
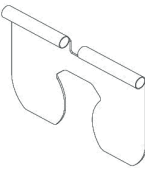

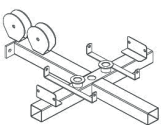
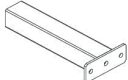
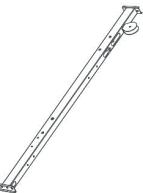
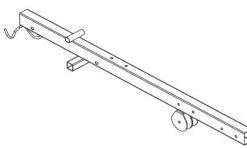
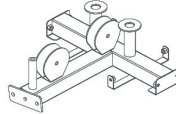
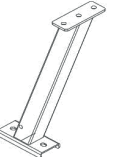
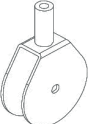
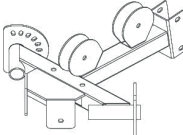
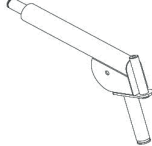

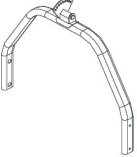
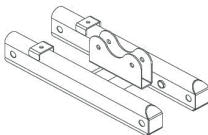
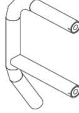
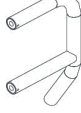
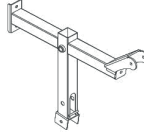
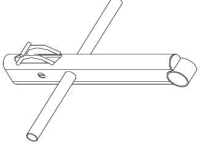
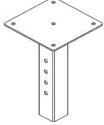

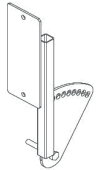
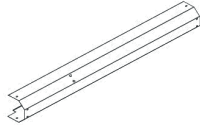
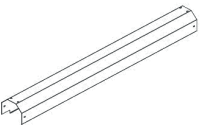
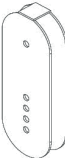

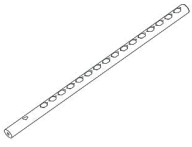
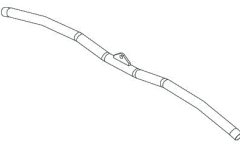

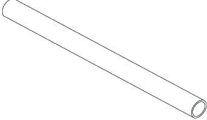

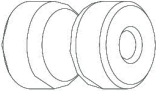
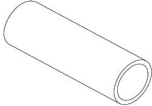

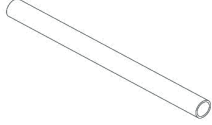

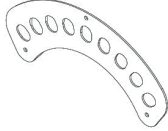

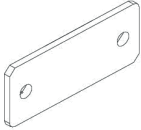



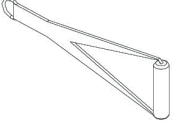
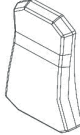
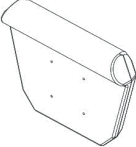
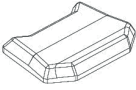
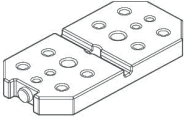
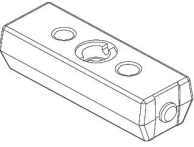
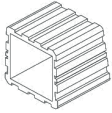
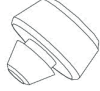
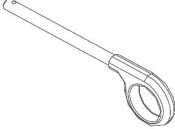



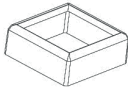
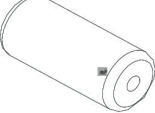

2.2 Scope of Delivery











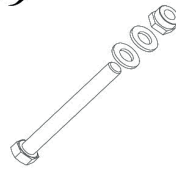
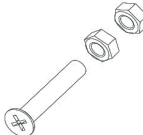

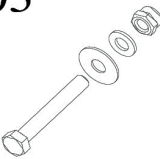

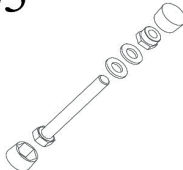



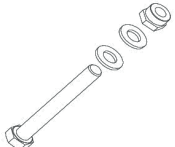

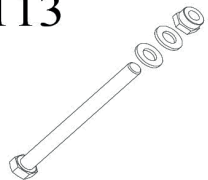









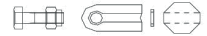



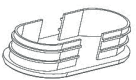

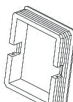

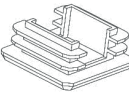
The scope of delivery consist of the following parts. At the beginning, check whether all parts and tools belonging to the device are included in the scope of delivery and whether damage has occurred. In the event of complaints, the contractual partner must be contacted directly.

⚠ CAUTION

If parts of the scope of delivery are missing or damaged, the assembly must not be carried out.

1 	2 	3 	4 	5 
6 	7 	8 	9 	10 
11 	12 	13 	14 	15 
16 	17 	18 	19 	20 
21 	22 	23 	24 	25 
26 	27 	28 	29 	30 

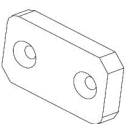
31 	32 	33 	34 	35 	
36 	37 	38 	39 	40 	
41 	42 	43 	44 	45 	
46 	47 	48 	49 	50 	
51 	79 	80 	81 	82 	
83 	84 	85 	86 	87 	
88 	89 	90 	90S 	91 	92 
93 	94 	95 	96 	97 	

98	99	100	101	102
				
103	104	105	106	107
				
108	110	111	112	113
				
114	115	116	117	118
				
119	120	121	122	123
	 	 		
124	125	126	127	128
				
129	130	131	132	148
				
149	150	151	152	154
				
155				
				

2.3 Assembly

Before assembly, take a close look at the individual assembly steps shown and carry out the assembly in the order given.

① NOTICE

First loosely screw all parts together and check that they fit properly. Then tighten the bolts using the tool only when you are instructed to do so.

Step 1

1. Place the end caps (79) onto the base frame (1), the bottom cross connector (6) and the side row connector (7).
2. Screw two bolts (97) into the bottom side of the bottom cross connector (6).
3. Mount the bottom cross connector (6) and the side row connector (7) to the base frame (1) with two bolt sets (96).
4. Mount the front upright frame (A8) to the base frame (1) with two bolt sets (95).
5. Mount the rear connector (11) to the base frame (1) with two bolt sets (95).
6. Mount the rear upright frame (5) to the base frame (1) with two bolt sets (95).
7. Tighten all bolts with the tool.

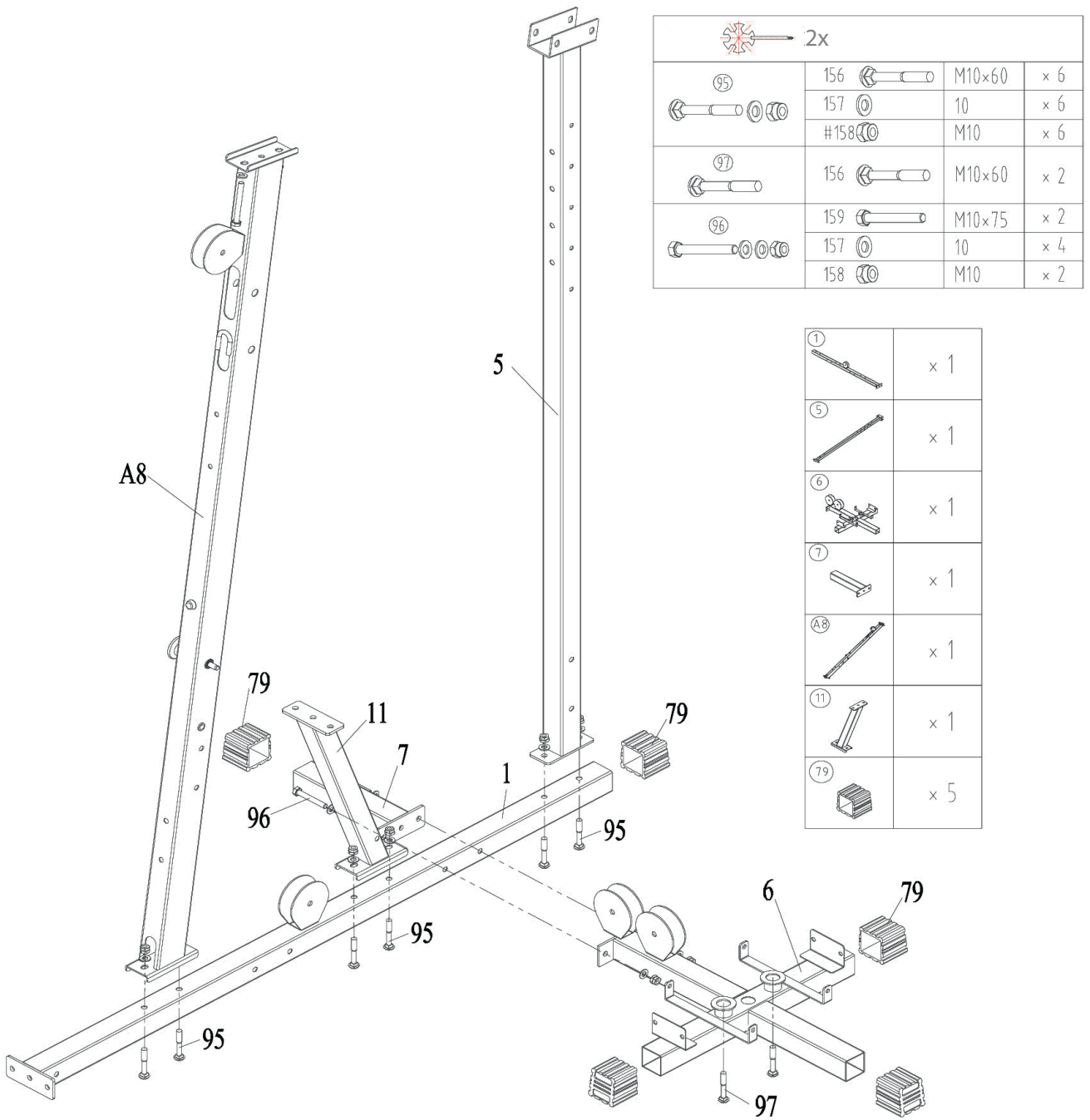

Step 2

1. Mount the top frame (9) to the rear upright frame (5) with two bolt sets (96).
2. Mount the joint plate (42) and the top frame (A9) to the front upright frame (A8) with two bolt sets (99)..
3. Tighten all bolts with the tool.

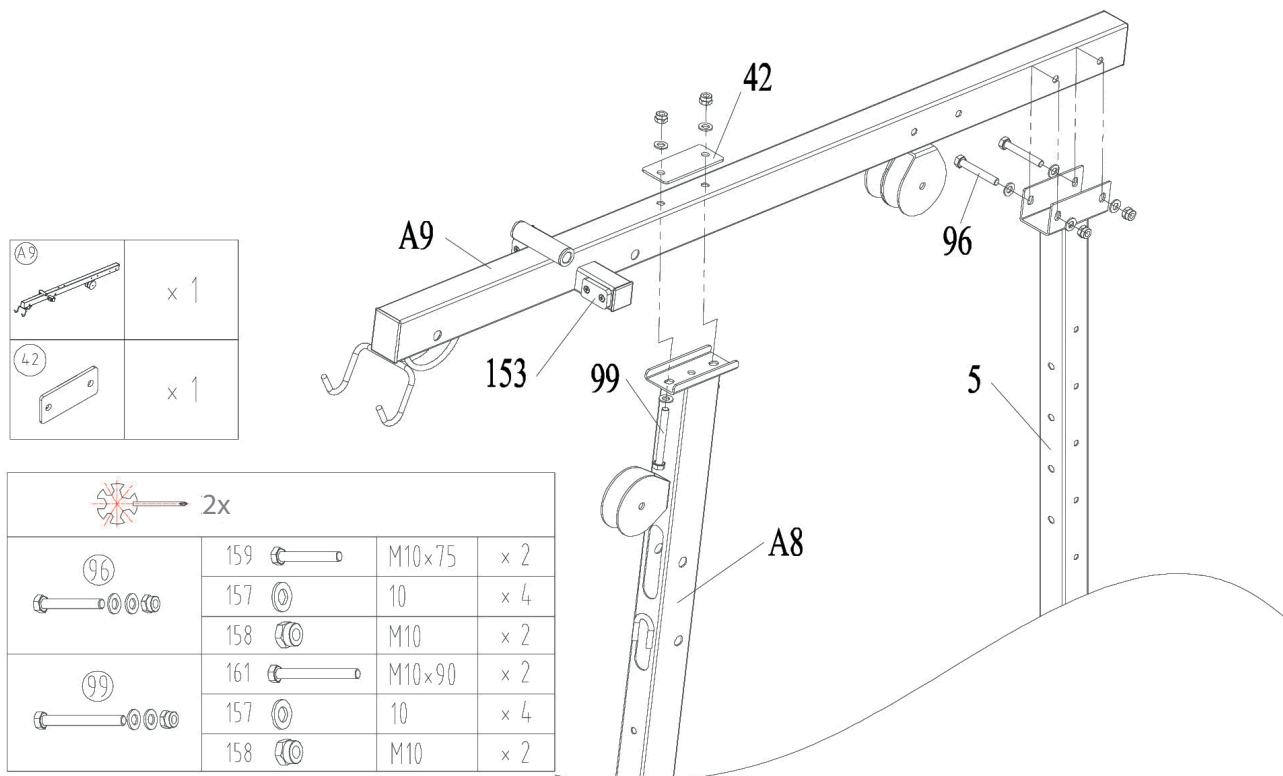



Step 3







1. Screw both guide rods (28) onto the bottom cross connector (6).
2. Shove one buffer (82) over each guide rod (28).
3. Place the plates of the weight stack (50) onto the guide bars (28) one by one.
4. Mount the top plate (51) with the stabilizer (83) to the selector rod (29).
5. Put the selector rod (29) over the guide rods (28) into the slot of the weight stack plates (50).
6. Place one buffer (82) onto each guide rod (28).

NOTICE

Two buffers (82) should be installed at the end under the weight stack plates (50) and two buffers (82) above the top plate (51).

7. Insert the selector pin (81) into the slots of the weight plates (50).

		x 1
---	---	-----



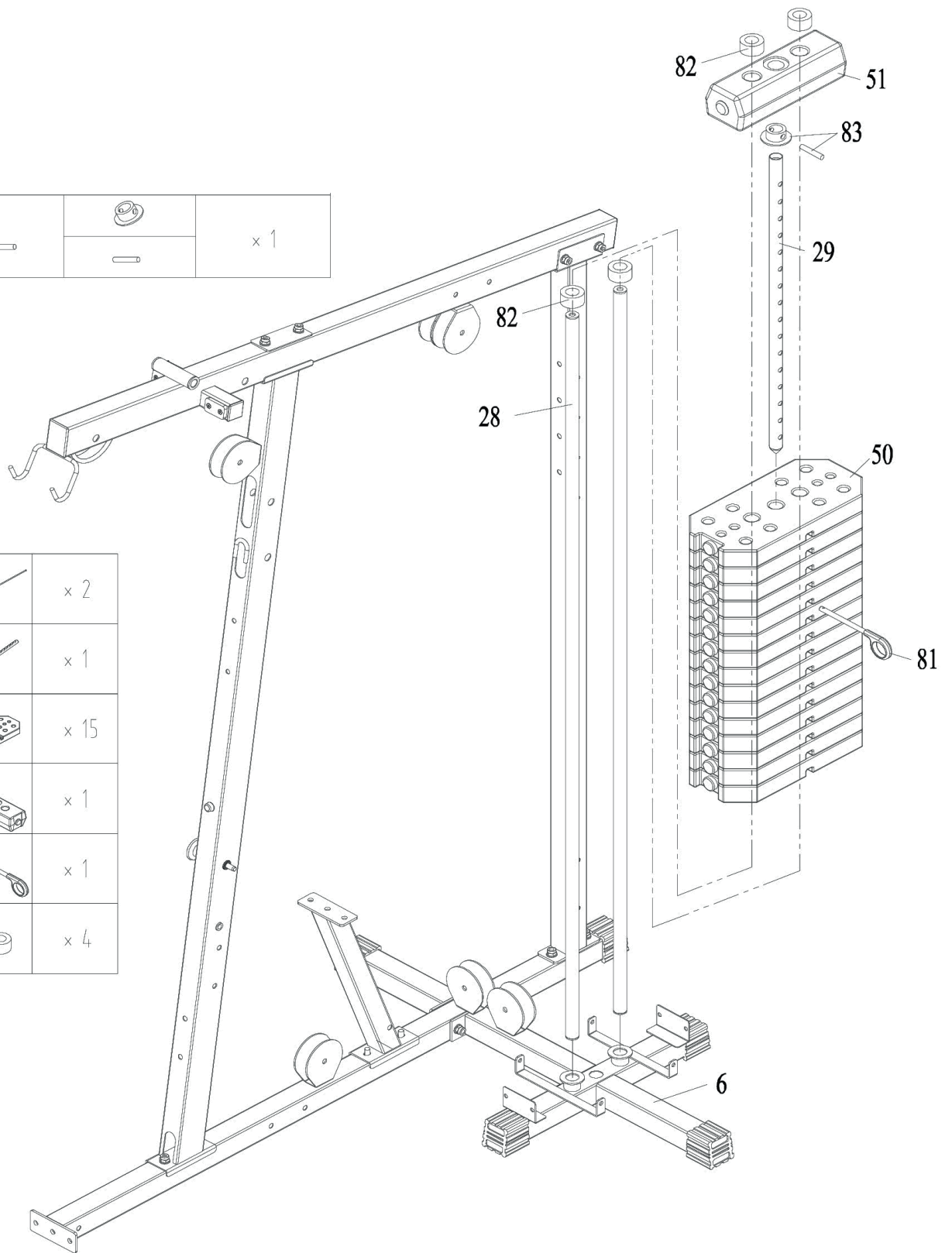



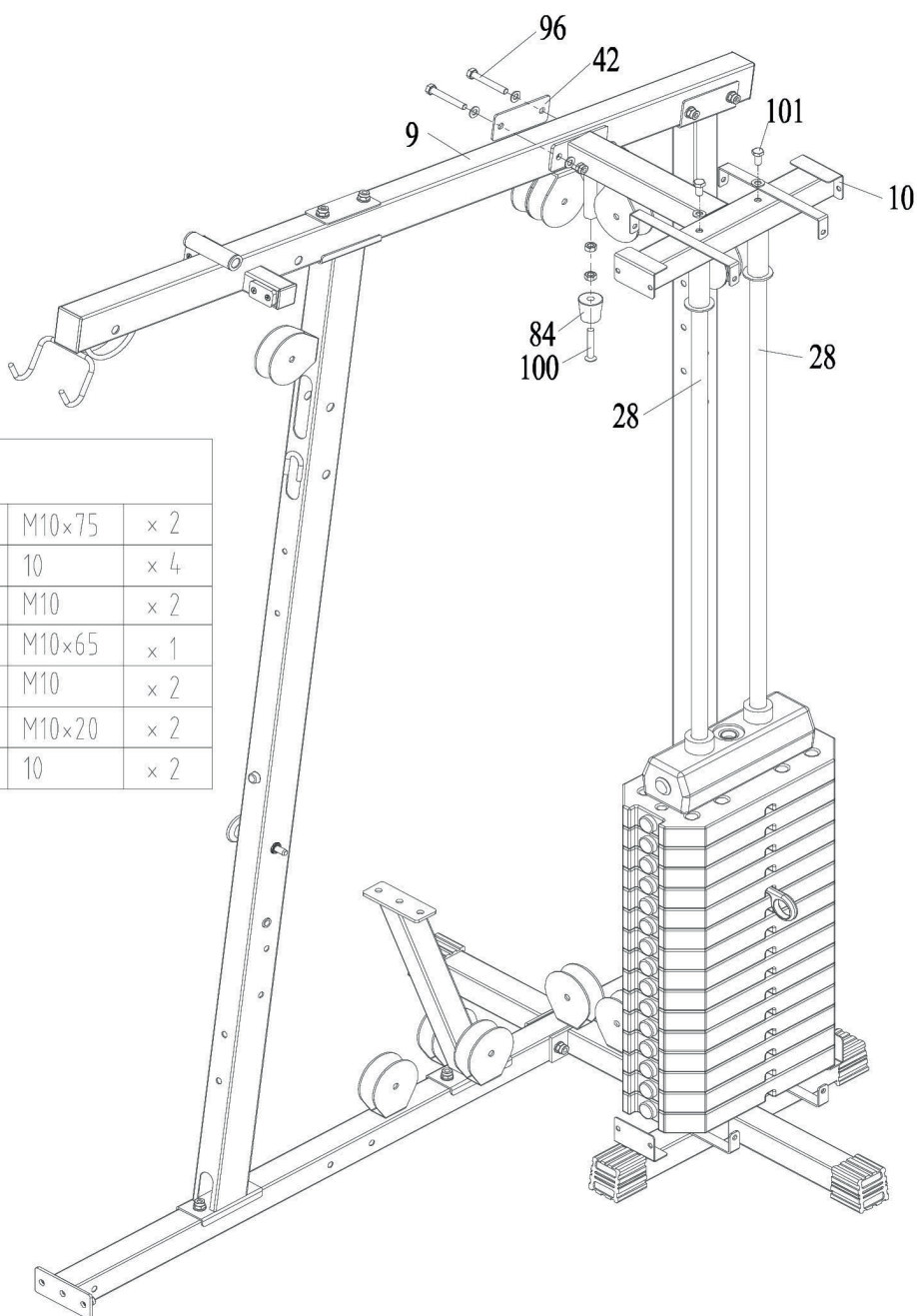

	x 2
	x 1
	x 15
	x 1
	x 1
	x 4

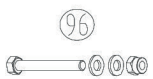

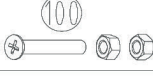

Step 4

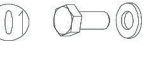
1. Mount the fixing bracket (10) to the guide rods (28) with two bolt sets (101).
2. Mount the joint plate (42) and the fixing bracket (10) to the top frame (9) with two bolt sets (96).
3. Mount the buffer (84) to the fixing bracket (10) with one bolt set (100).
4. Tighten all bolts with the tool.



 → 2x			
	159		M10×75 × 2
	157		10 × 4
	158		M10 × 2
	162		M10×65 × 1
	163		M10 × 2
	164		M10×20 × 2
	157		10 × 2

	× 1
	× 1
	× 1





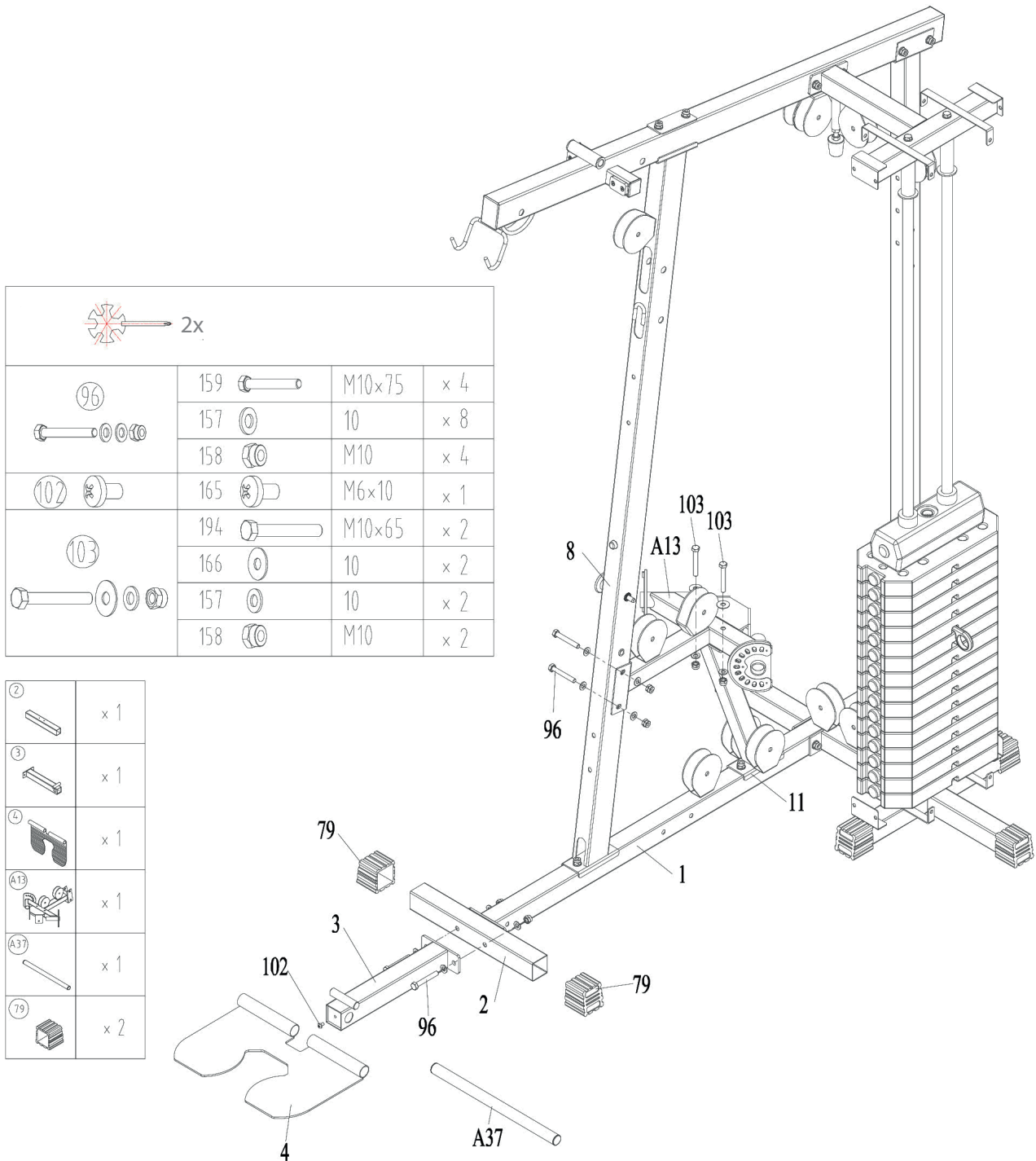











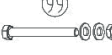





Step 5

1. Mount the cable arm assemble (A13) to the rear connector (11) with two bolt sets (103).
2. Screw the cable arm assemble (A13) to the front upright frame (A8) with two bolt sets (96).
3. Place the end caps (79) onto the front base tube (2).
4. Mount the low row connector (3) and the front base tube (2) to the base frame (1) with two bolt sets (96).
5. Mount the foot plate (4) to the low row connector (3) and insert the round tube (A37). Secure the connection with a screw (102).
6. Tighten all bolts with the tool.









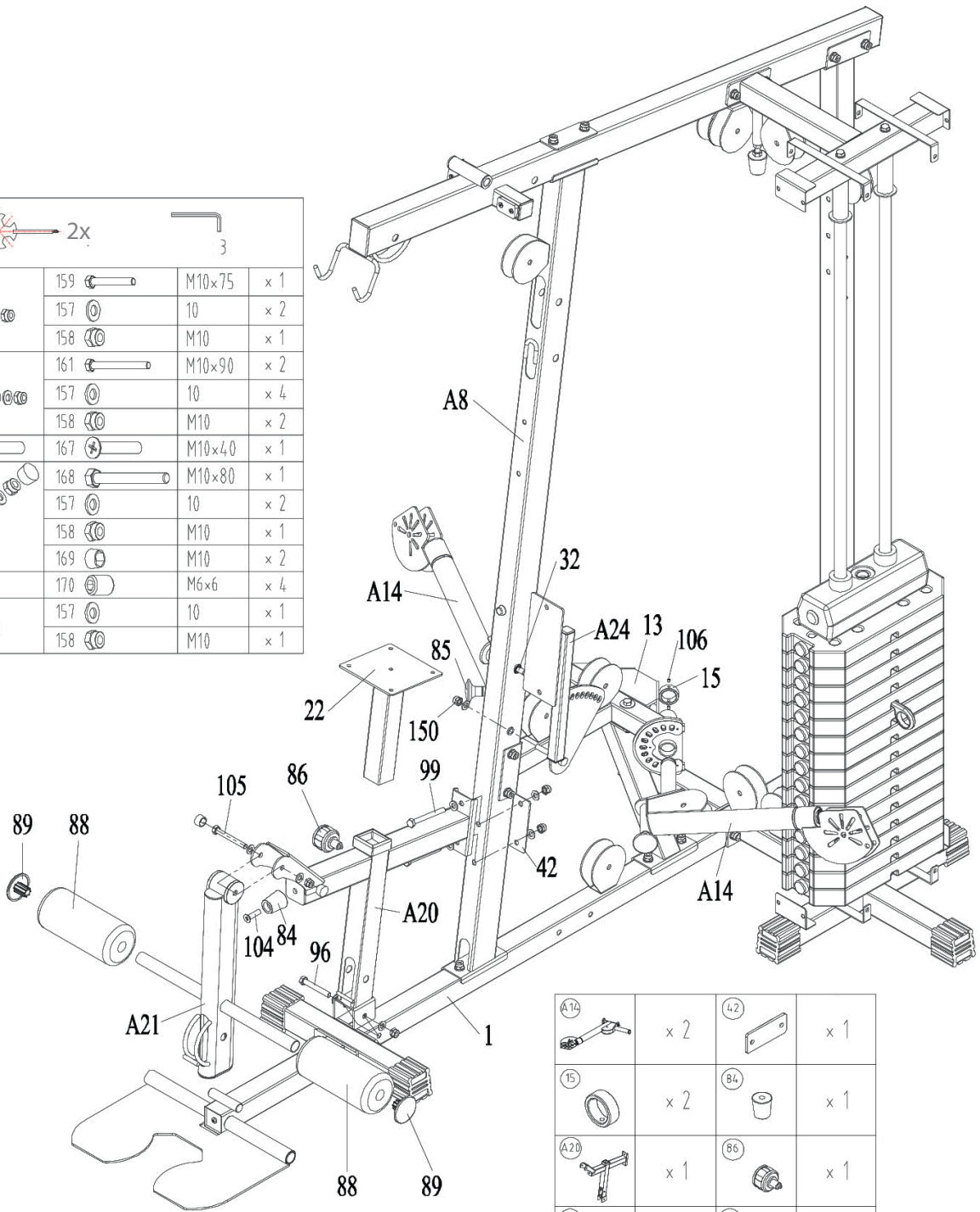



Step 6

1. Mount the seat cushion support (A20) to the base frame (1) with one bolt set (96).
2. Insert the cushion support (22) into the seat cushion support (A20) and secure the connection with the fast pin (86).
3. Mount the seat cushion support (A20) and the joint plate (42) to the front upright frame (8) with two bolt sets (99).
4. Mount the buffer (84) to the seat cushion support (A20) with a screw (104).
5. Mount the leg extension (21) to the cushion support (A20) with one bolt set (105).
6. Shove the foam roller (88) over the ends of the leg extension (21) and secure them with one plug (89) on each side.
7. Mount the back cushion support (A24) to the front upright frame (8) with one bolt set (150).
8. Mount both cable arms (A14) to the cable arm assemble (A13), place the axle collars (15) on both cable arms (A14) and secure each with two bolts (106).
9. Tighten all bolts with the tool.







	→ 2x		3
	159		M10x75 x 1
	157		10 x 2
	158		M10 x 1
	161		M10x90 x 2
	157		10 x 4
	158		M10 x 2
	167		M10x40 x 1
	168		M10x80 x 1
	157		10 x 2
	158		M10 x 1
	169		M10 x 2
	170		M6x6 x 4
	157		10 x 1
	158		M10 x 1









	x 2		x 1
	x 2		x 1
	x 1		x 1
	x 1		x 2
	x 1		x 2
	x 1		

Step 7

1. Mount the press arm selector (A17) to the top frame (A9) and guide the pivot axle (31) through. Insert a screw (36) into the pivot axle (31) and secure it with a nut set (108).
2. Mount the press arm (A16) to the press arm selector (A17) and guide the pivot axle (31) through.
3. Insert a screw (36) into the pivot axle (31) and secure it with a nut set (108).
4. Mount the left hand grip (18) to the left side of the press arm (A16) with two bolt sets (107).
5. Mount the right hand grip (18) to the right side of the press arm (A16) with two bolt sets (107).
6. Tighten all bolts with the tool.

			
	171 	M12x20	x 4
	172 	12	x 4
	172 	12	x 4
	173 	M12	x 4



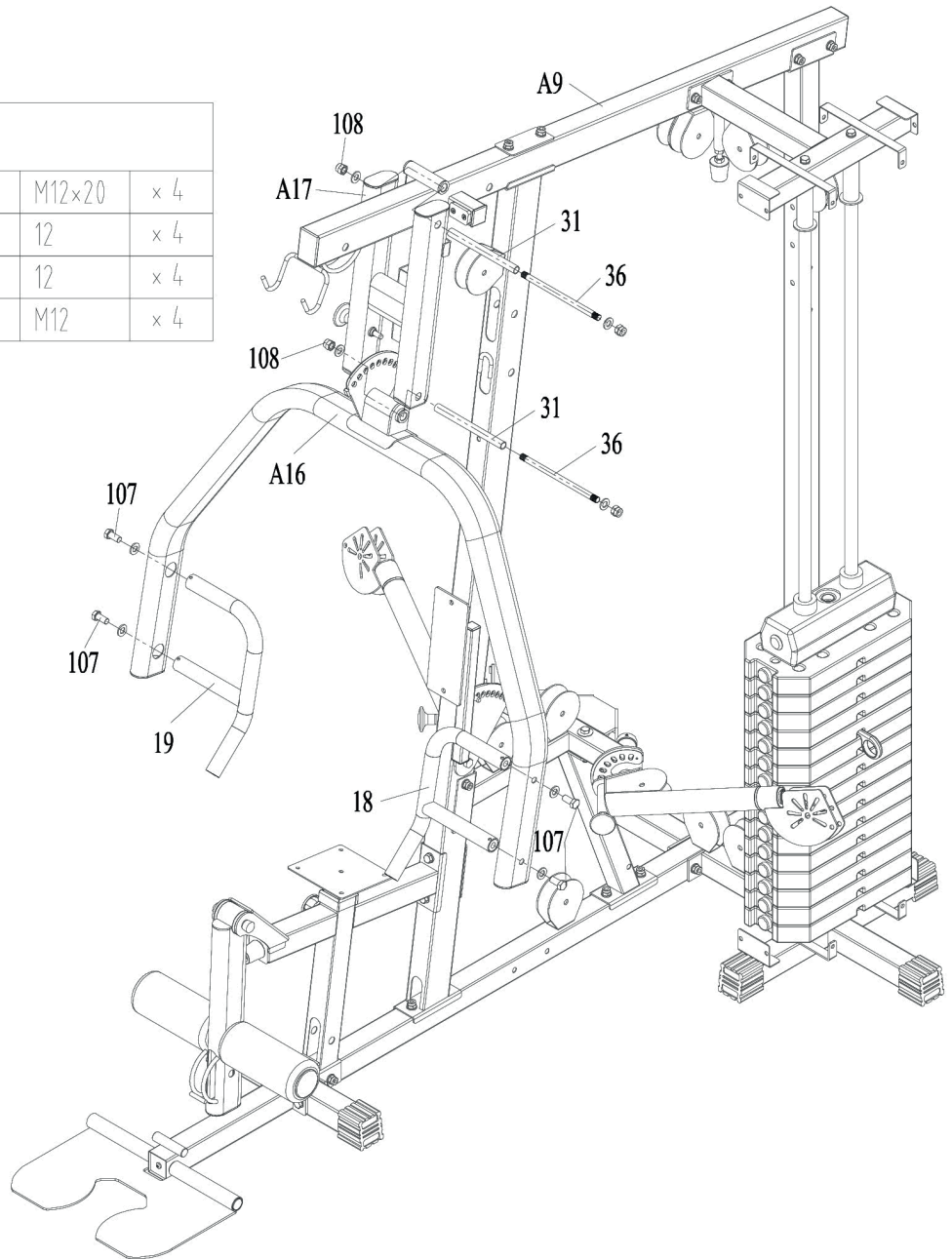





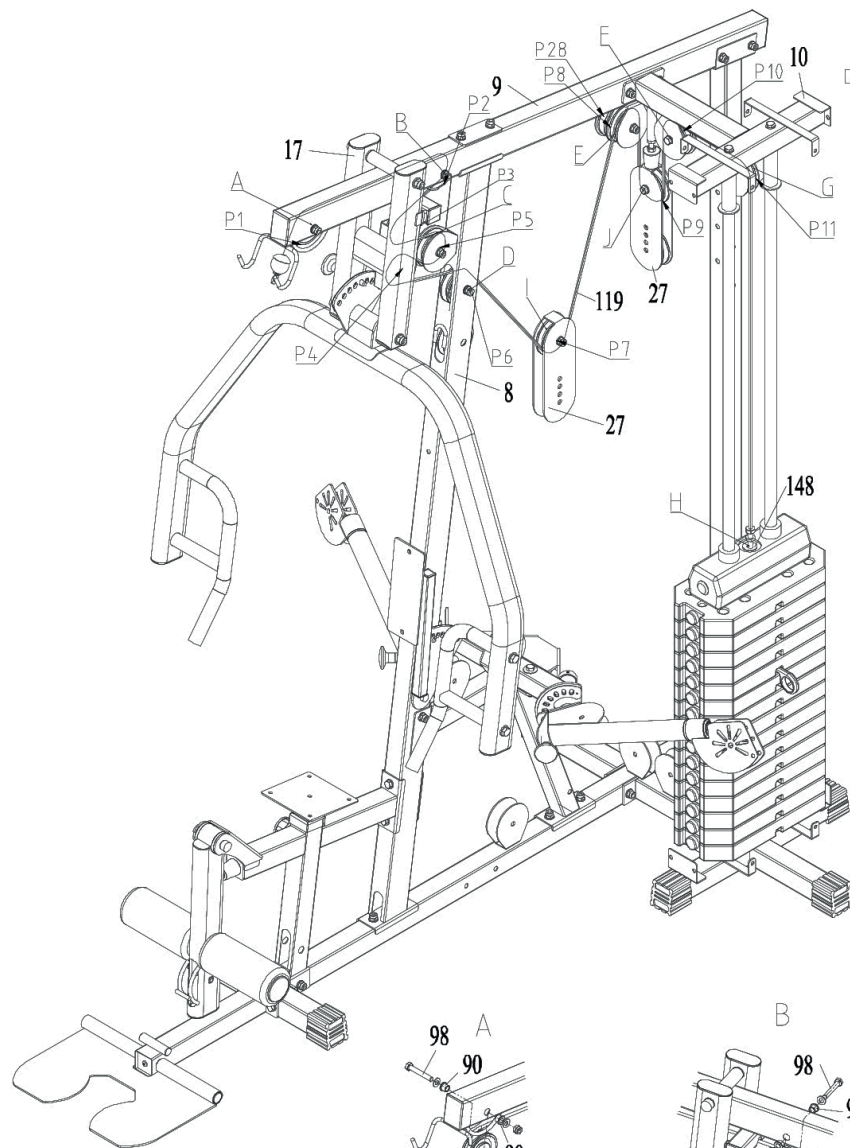





	x 1
	x 1
	x 1
	x 1
	x 2
	x 2





Step 8

1. Figure A: Place the two plastic bushings (90) into the top frame (9). Place cable 1 (119) on pulley P1 (91). Mount pulley P1 (91) to the top frame (9) with one bolt set (98).
2. Figure B: Place two plastic bushings (90) into the top frame (9). Place cable 1 (119) on pulley P2 (91). Mount the pulley P2 (91) to the top frame (9) with one bolt set (98).
3. Figure C: Guide cable 1 (119) over pulley P3 (91) through the left side downwards and mount the pulley P3 (91) to the back of the press arm selector (17) with one bolt set (152). Guide cable 1 (119) underneath pulley P3 (91) right over pulley P5 (91) downwards. Mount pulley P5 (91) to the front upright frame (8) with one bolt set (152). Guide cable 1 (119) over pulley P4 (91) coming from underneath of pulley P5 (91) through the left side downwards. Mount pulley P4 (91) to the back of the press arm selector (17) with one bolt set (152).
4. Figure D: Place two plastic bushings (90) into the front upright frame (8). Mount pulley P6 (91) to the front upright frame (8) with one bolt set (98). Guide cable 1 (119) over pulley P6 (91) coming from underneath of pulley P4 (91) through the front upright frame (8).
5. Figure E: Place cable 1 (119) on pulley P8 (91). Mount pulley P28 (91) and pulley P8 (91) to the top frame (9) with one bolt set (111).
6. Figure F: Place cable 1 (119) on pulley P10 (91). Mount pulley P10 (91) to the fixing bracket (10) with a bolt set (152).
7. Figure G: Place cable 1 (119) on pulley P11 (91). Mount pulley P11 (91) to the fixing bracket (10) with a bolt set (152).
8. Figure H: Mount cable 1 (119) with a big washer (148) to the selector rod (29).
9. Figure I: Mount pulley P7 (91) to the adjustable pulley block (27) with one bolt set (152). Place the adjustable pulley block (27) on cable 1 (119).
10. Figure J: Mount pulley P9 (91) to the adjustable pulley block (27) with one bolt set (152). Place the adjustable pulley block (27) on cable 1 (119).
11. Tighten all bolts with the tool.



 2x			
	160		M10x70 x 3
	157		10 x 6
	158		M10 x 3
	195		M10x45 x 7
	157		10 x 14
	158		M10 x 7
	175		M10x85 x 1
	157		10 x 2
	158		M10 x 1
			x 6
			x 1

	x 2
	x 12
 L=120	x 1

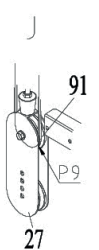
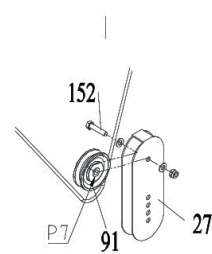
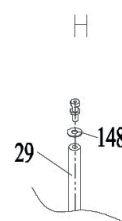
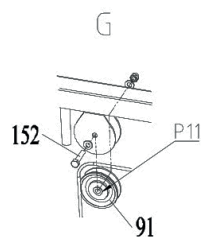
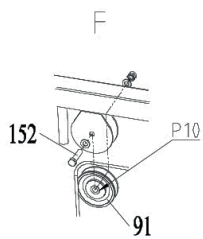
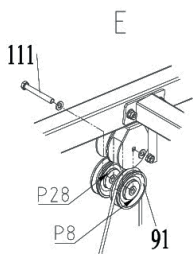
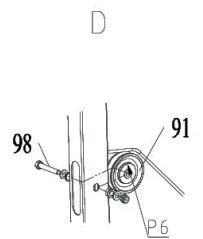
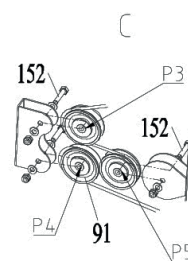
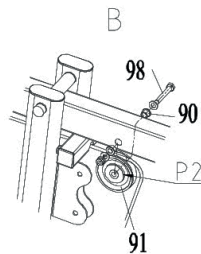
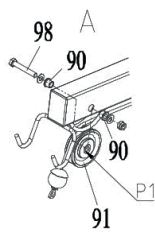

Step 9

1. Figure A: Place two plastic bushings (90S) into the leg extension (A21). Place cable 2 (120) on the $\text{\O}100$ pulley P12 (92). Mount the $\text{\O}100$ pulley P12 (92) to the leg extension (A21) with one bolt set (112).
2. Figure B: Place two plastic bushings (90) into the seat cushion support (A20). Place the pulley P13 (91) on cable 2 (120) and mount the pulley P13 (91) to the seat cushion support (A20) with one bolt set (98).
3. Figure C: Guide cable 2 (120) through the pulley holder on the base frame (1) and mount pulley P14 (91) with one bolt set (152).
4. Figure D: Guide cable 2 (120) upwards through the pulley holder on the cable arm assemble (A13) and mount pulley P15 (91) to the pulley holder with one bolt set (152).
5. Figure E: Mount pulley P16 (91) to the adjustable pulley block (27) with one bolt set (152). Guide cable 2 (120) coming from below over pulley P16 (91).
6. Figure F: Mount pulley P17 (91) to the pulley holder on the cable arm assemble (A13) with one bolt set (152). Guide cable 2 (120) coming from above along underneath pulley P17 (91).
7. Figure G and H: Guide cable 2 (120) through the front upright frame (A8) and fix cable 2 (120) with the respective bolt set. Place two plastic bushings (90) into the front upright frame (A8). Place the pulley P18 (91) into the front upright frame (A8) and mount pulley P18 (91) with one bolt set (98).
8. Tighten all bolts with the tool.

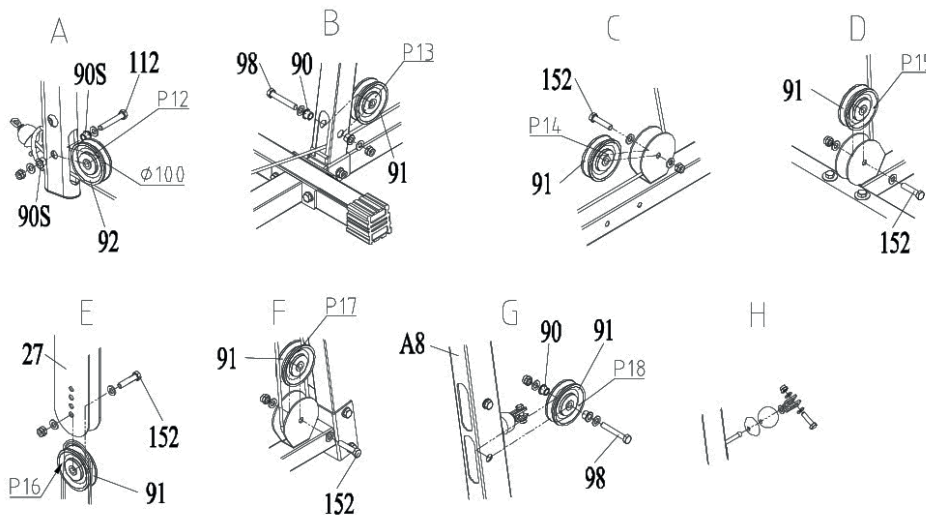

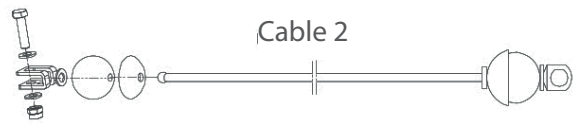
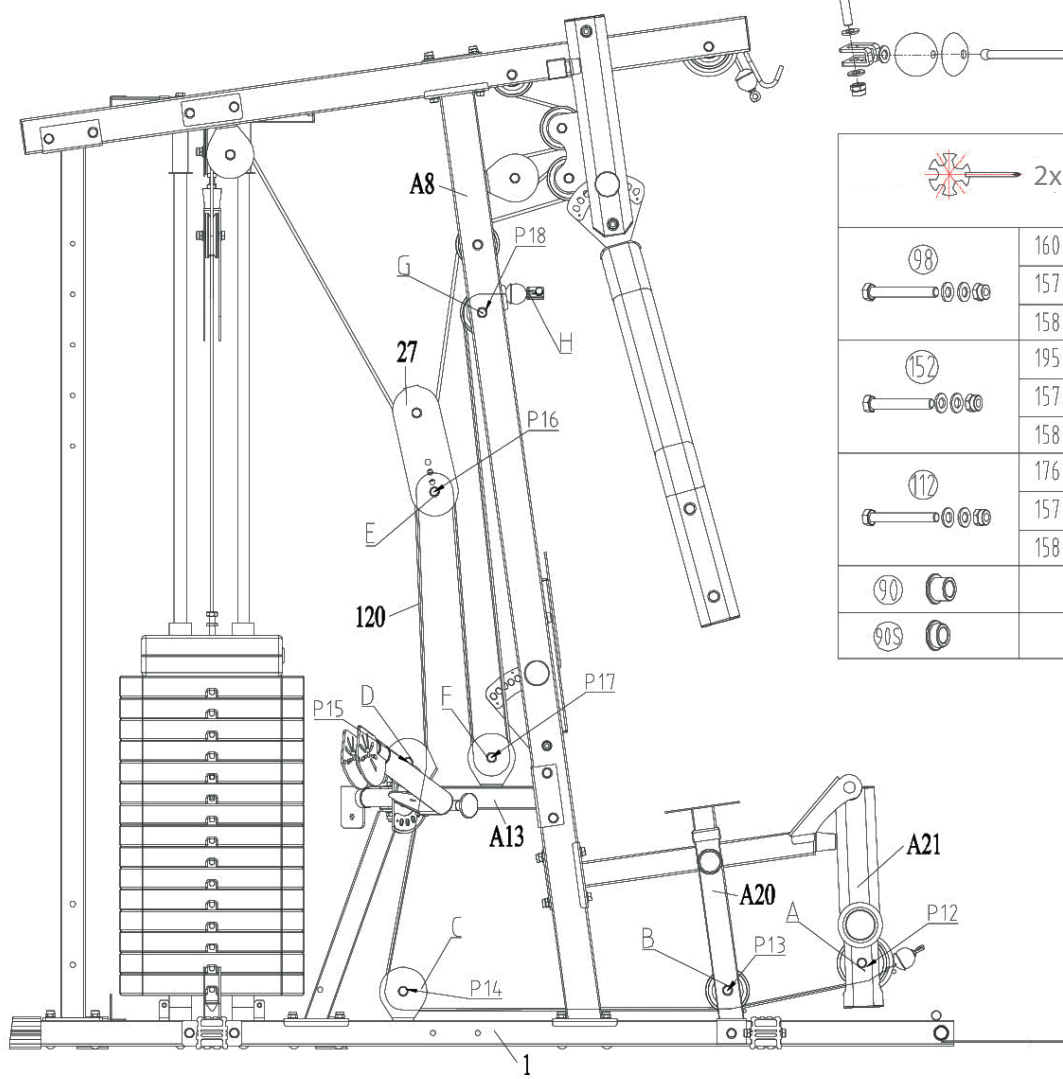

Cable 2

2x			
	160		M10×70 × 2
	157		10 × 4
	158		M10 × 2
	195		M10×45 × 4
	157		10 × 8
	158		M10 × 4
	176		M10×55 × 1
	157		10 × 2
	158		M10 × 1
	× 4		
	× 2		

	x 6
	x 1
	x 1

Step 10

1. Figure A: Fix cable 3 (121) to the rotational pulley block (23) with one gyro wheel (33), one bushing (34) and one bolt set (114). Guide cable 3 (121) over pulley P19 (91) and mount pulley P19 (91) to the rotational pulley block (23) with one bolt set (110).
2. Figure B: Fix the cable 3 (121) with pulley P20 (91) to the cable arm (14) with one bolt set (110).
3. Figure C: Guide cable 2 (121) over pulley P21 (91) through the pulley block (41) and mount it to the cable arm assemble (13) with one bolt set (110).
4. Figure D: Mount two pulley blocks (41) and the pulleys P22 and P24 (91) to the rear connector (11) with one bolt set (113). Guide cable 3 (121) underneath pulley P24 (91) trough the pulley block (41).
5. Figure F: Guide cable 3 (121) over pulley P23 (91) and mount pulley P23 (91) to the pulley block (12) with one bolt set (152).
6. Figure D: Guide cable 3 (121) from the back underneath pulley P22 (91) through the pulley block (41).
7. Figure E: Guide cable 3 (121) over pulley P25 (91) through the pulley block (41) and mount it to the cable arm assemble (13) with one bolt set (110).
8. Figure G: Fix cable 3 (121) with pulley P20 (91) to the cable arm (14) with one bolt set (110).
9. Figure H: Guide cable 3 (121) over pulley P27 (91) and mount pulley P27 (91) to the rotational pulley block (23) with one bolt set (110). Fix cable 3 (121) to the rotational pulley block (23) with one gyro wheel (33), one bushing (34), one bolt set (114) and the respective bolt set from cable 3 (121).
10. Tighten all bolts with the tool.

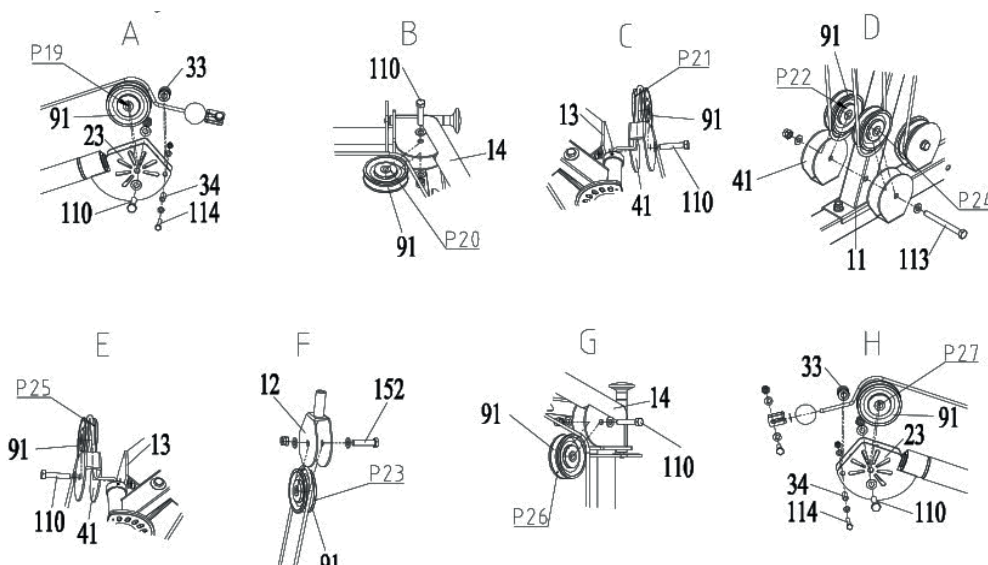

Cable 3

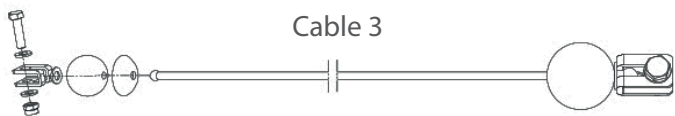

	174		M10x50	x 6
	157		10	x 12
	158		M10	x 6
	195		M10x45	x 1
	157		10	x 2
	158		M10	x 1
	177		M10x125	x 1
	157		10	x 2
	158		M10	x 1
	178		M6x45	x 2
	179		6	x 4
	180		M6	x 2

	x 1
	x 2
	x 2
	x 4
	x 9
	x 1

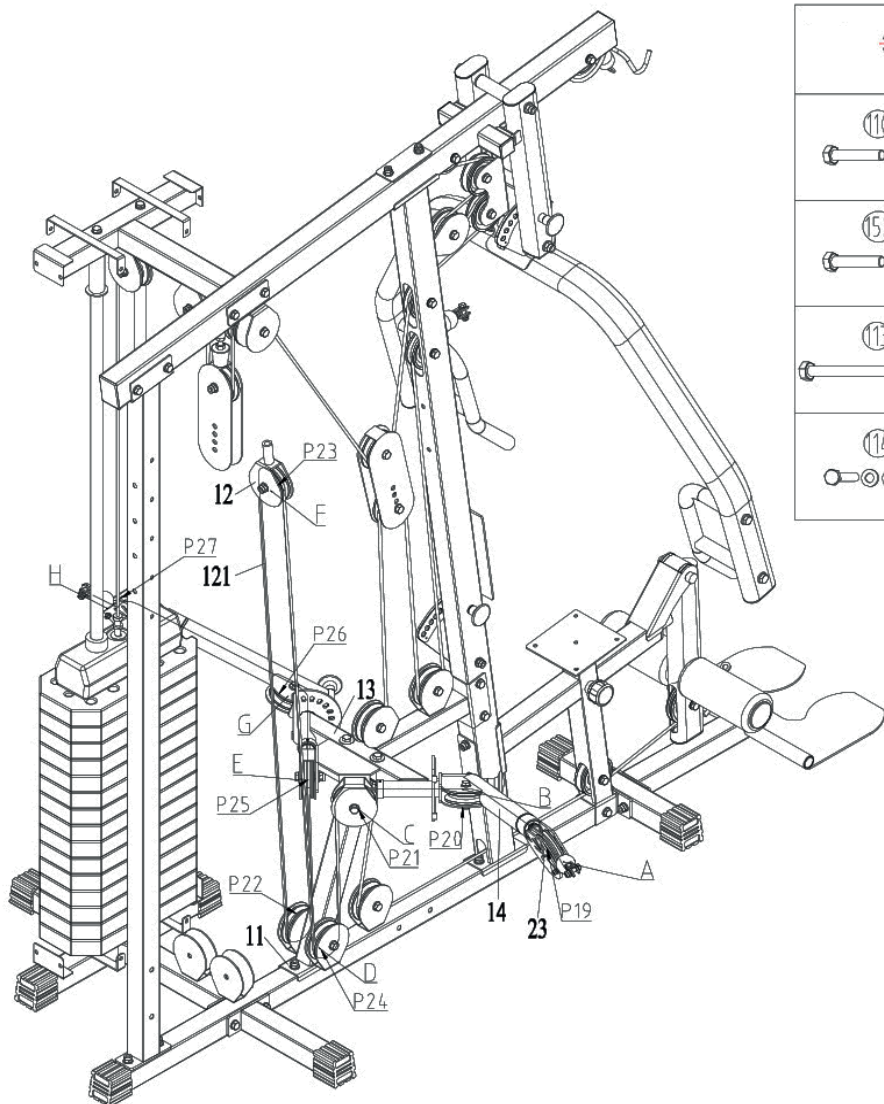



Step 11

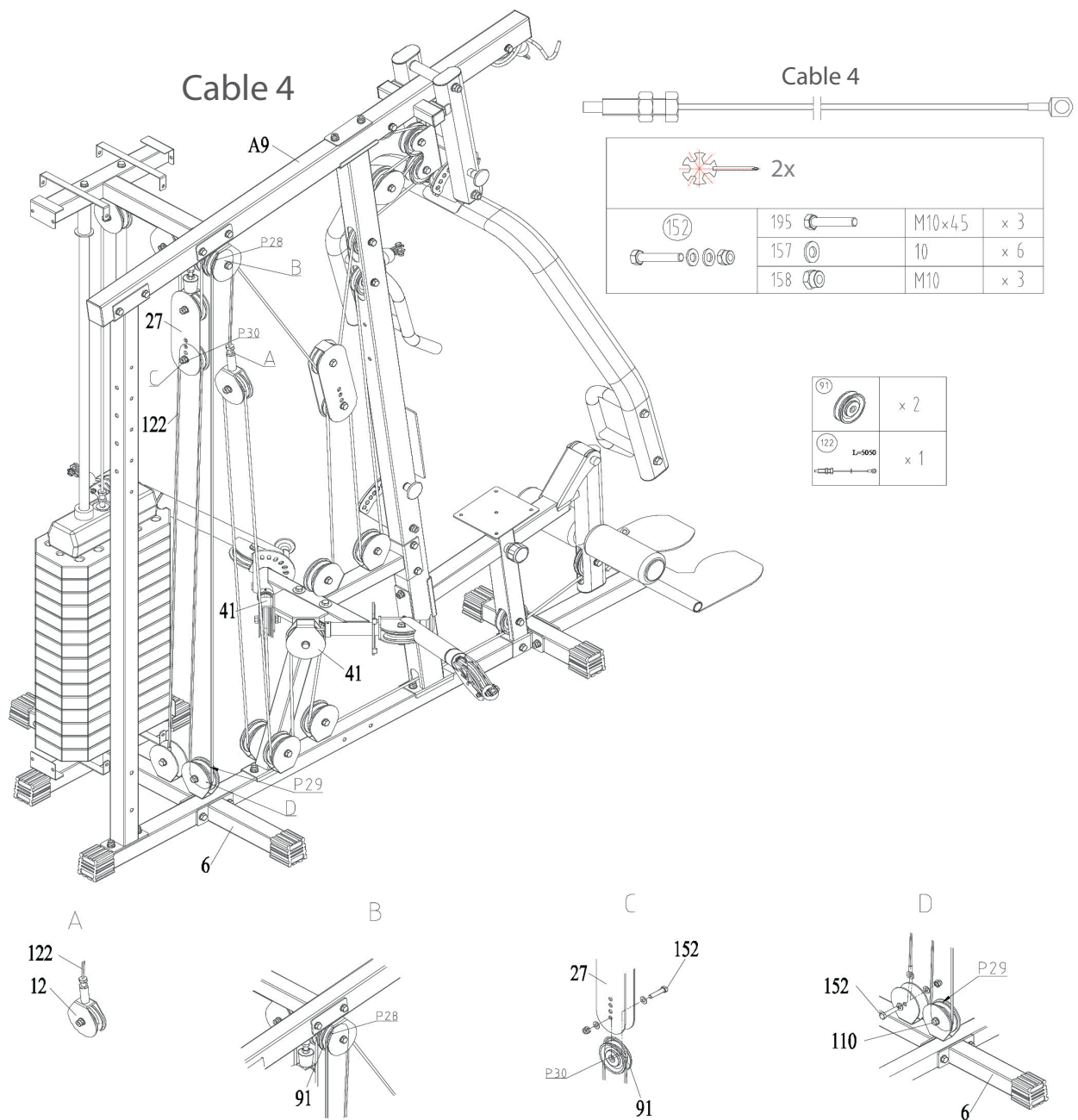

1. Figure A: Screw cable 4 (122) into the upper part of the pulley block (12).
2. Figure B: Guide cable 4 (122) over pulley P28 (91) backwards.
3. Figure D: Guide the cable 4 (122) downwards and underneath pulley P29 (91). Mount pulley P29 (91) to the pulley holder on the bottom cross connector (6) with one bolt set (110).
4. Figure C: Guide cable 4 (122) upwards through the adjustable pulley block (27) over pulley P30 (91). Mount pulley P30 (91) to the adjustable pulley block (27) with one bolt set (152).
5. Figure D: Fix cable 4 (122) to the pulley holder on the bottom cross connector (6) with one bolt set (152).
6. Tighten all bolts with the tool.

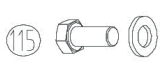

Step 12

1. Mount the left iron shell (25) to the bottom cross connector (6) and the fixing bracket (10) with four bolt sets (115).
2. Mount the right iron shell (26) to the bottom cross connector (6) and the fixing bracket (10) with four bolt sets (115).
3. Tighten all bolts with the tool.

				
	181		M8x16	x 16
	182		8	x 16



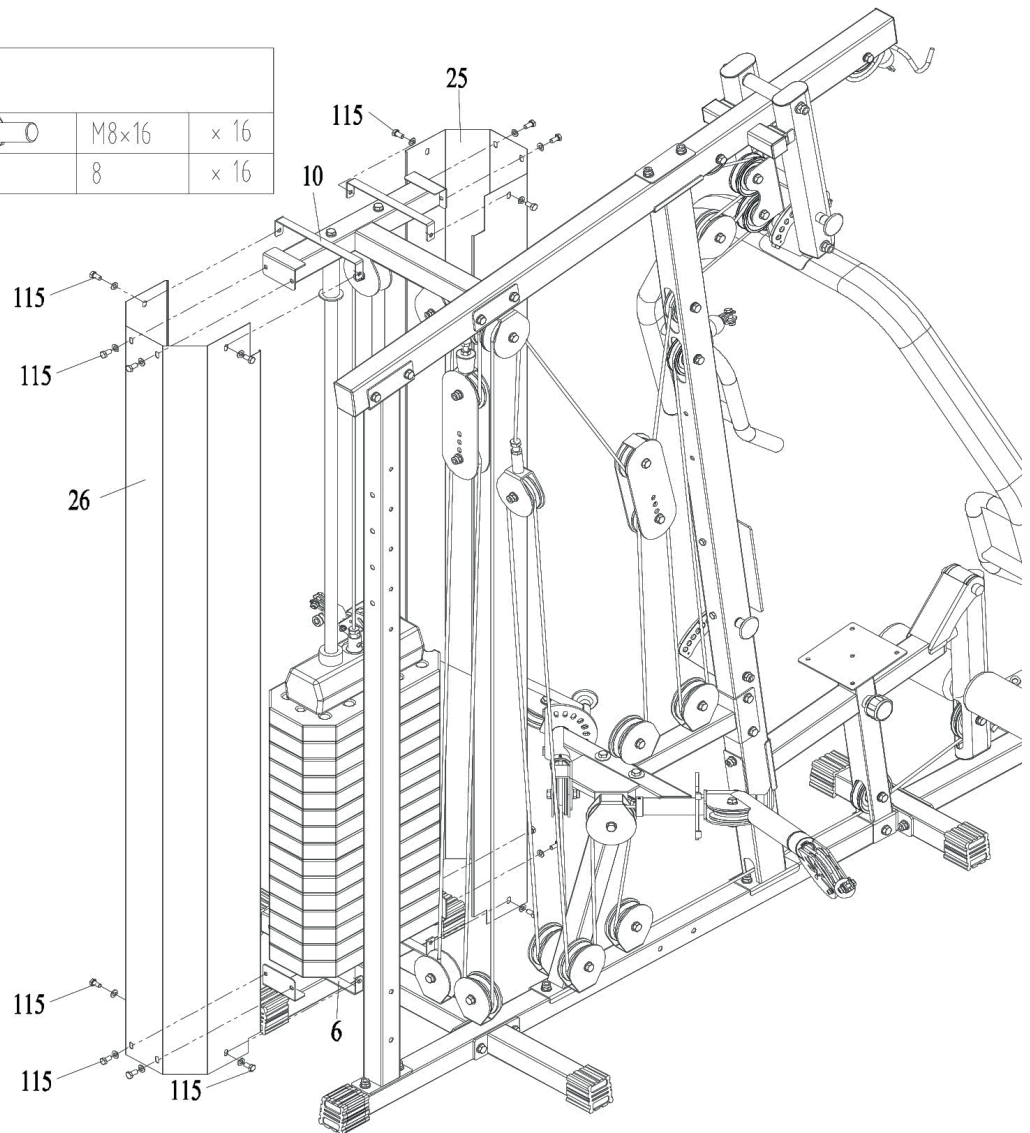

	x 1
	x 1



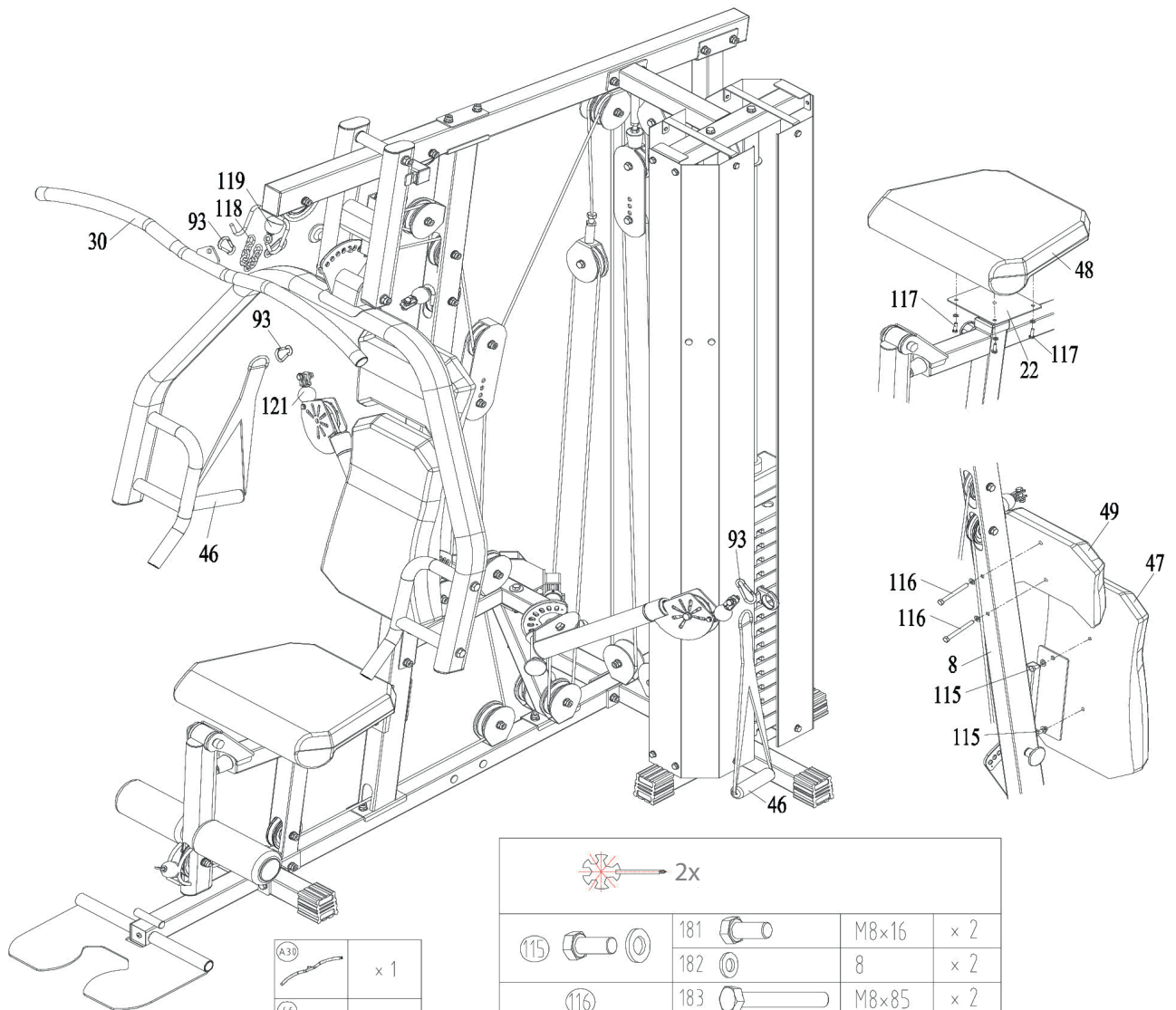











Step 13

1. Mount the seat cushion (48) to the cushion support (22) with four bolt sets (117).
2. Mount the headrest cushion (49) to the front upright frame (8) with two bolt sets (116).
3. Mount the back cushion (47) to the front upright frame (8) with two bolt sets (115).
4. Attach one hand grip (46) to each side on the end of cable 3 (121) with each one hoist hook (93).
5. Attach the lat bar (30) to cable 1 (119) with two hoist hooks (93) and one chain (118).
6. Tighten all bolts with the tool.



 A30	x 1
 46	x 2
 47	x 1
 48	x 1
 49	x 1

 2x	
 115	181  M8x16 x 2
	182  8 x 2
 116	183  M8x85 x 2
	182  8 x 2
 117	184  M6x20 x 4
	179  6 x 4
 93	x 4
 118	x 1

Step 14

Place the plugs (94) into the holes of the base frame (1), rear upright frame (5) and the bottom cross connector (6).

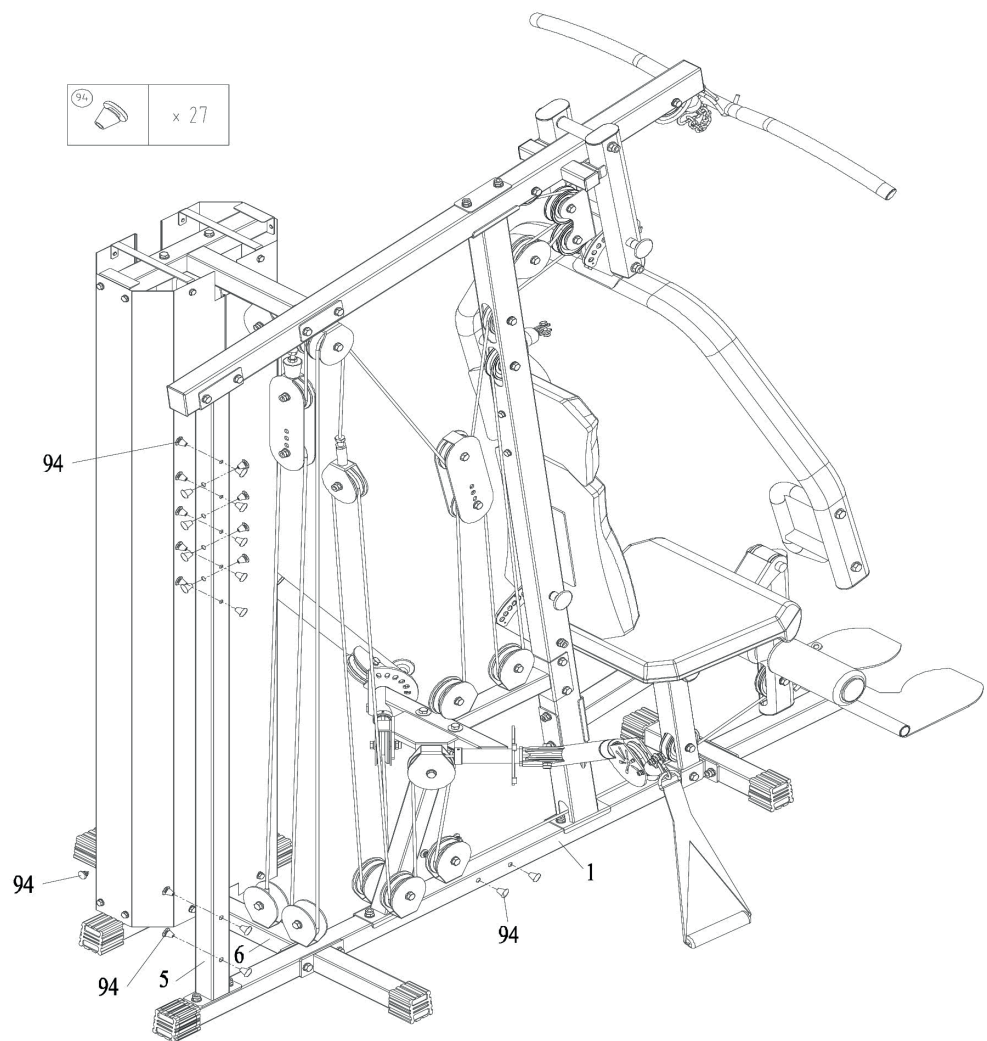

2.4 Cable Installation Overview

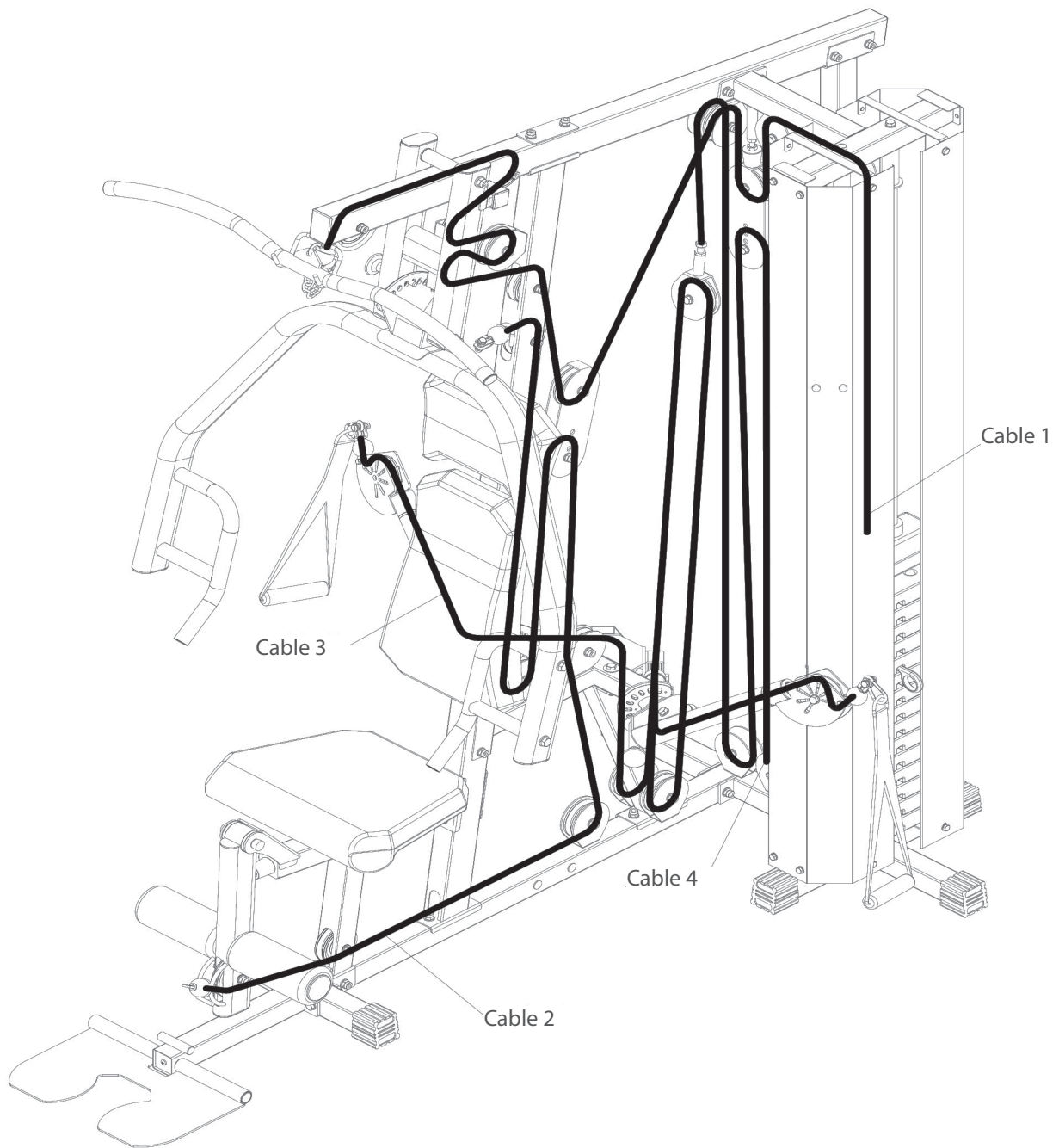

3.1 General Instructions

▶ **ATTENTION**

- + Make sure that the equipment is protected from moisture, dust and dirt in the selected storage location. The storage location should be dry and well ventilated and have a constant ambient temperature between 5°C and 45°C.

 **WARNING**

- + The storage location should be chosen so that improper use by third parties or children can be prevented.
- + If your equipment does not have transportation wheels, the equipment must be disassembled before transportation.

4.1 General Instructions



WARNING

- + Do not make any improper changes to the equipment.



CAUTION

- + Damaged or worn components may affect your safety and the life of the equipment. Therefore, immediately replace damaged or worn components. In such a case, contact the contract partner. The equipment must not be used until it has been repaired. If necessary, use only original spare parts.

► ATTENTION

- + In addition to the instructions and recommendations for maintenance and care given here, additional service and/or repair work may be necessary; this must only be carried out by authorised service technicians.

4.2 Faults and Fault Diagnosis

The equipment undergoes regular quality controls during production. Nevertheless, faults or malfunctions may occur. Frequently, individual parts are responsible for these disturbances, an exchange is usually sufficient. Please refer to the following overview for the most common errors and how to correct them. If the equipment still does not function properly, contact your contract partner.

Fault	Cause	Solution
Grinding noise	Cables or pulleys do not run clean or are damaged	Visual inspection of the cable run or pulley bearing
Weight is hanging in the air	Cables too tightly tensioned	Readjust cable tension
Cable without tension	Cable too loose	Readjust cable tension
Squeaking & cracking noises	Loose or too tight bolt connection	Check or lubricate bolt connection

4.3 Maintenance and Inspection Calendar

To avoid damage from body sweat, the equipment must be cleaned with a damp towel (no solvents!) after each training session.

The following routine tasks must be performed at the specified intervals:

Part	Weekly	Monthly	Quarterly	Half-yearly	Yearly
Cables and pulleys	C/I				
Bolt connections		I			
Pulleys and cables	I				
C = clean; I = inspect					

5 DISPOSAL

At the end of its operational life, this equipment cannot be disposed of in normal household waste. Instead, it must be disposed of via an electricals recycling centre. Further information can be obtained from your local authority's recycling service.



The materials can be recycled as per their symbols. Through the reuse, recycling of materials or other forms of recovery of old equipment, you make an important contribution to the protection of the environment.

6 RECOMMENDED ACCESSORIES

To make your training experience even more efficient and pleasant, we recommend that you add suiting accessories to your fitness equipment. This could be a floor mat, for example, which makes your fitness equipment stand more securely and also protects the floor from falling sweat, but it could also be additional handrails on some treadmills or silicone spray to keep moving parts in good shape.

If you have purchased a fitness machine with pulse training and want to train your heart rate, we strongly recommend that you use a compatible chest strap, as this ensures optimum transmission of the heart rate. You may want to buy additional grips or weights for multi gyms.

Our range of accessories offers the highest quality and makes training even better. If you would like to find out more about compatible accessories, please go to the detail page of the product in our webshop (the easiest way is to enter the article number in the search field above) and go to the recommended accessories on this page. Of course, you can also contact our customer service: by telephone, e-mail, in one of our branches or via our social media channels. We will be happy to advise you!



floor mat



chest strap



chest strap contact gel



silicone spray



towels

7.1 Serial Number and Model Name

In order to provide you with the best possible service, please have the model name, article number, serial number, exploded drawing and parts list ready. The corresponding contact options can be found in chapter 9 of this operating manual.

NOTICE

The serial number of your equipment is unique. It's located on a white sticker. The exact position of this sticker is shown in the following illustration.

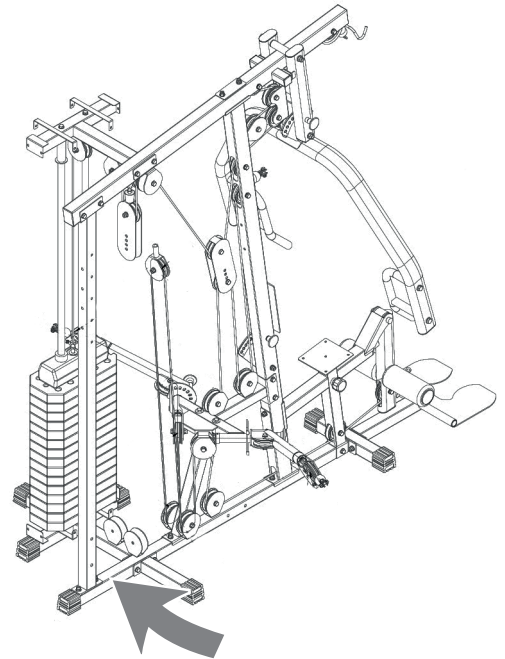

Enter the serial number in the appropriate field.

Serial number:

Brand / Category:

Taurus / multi-gym

Model Name:

WS3

Article Number:

TF-WS3-2

7.2 Parts List

No.	Name	Qty.
1	BASE FRAME	1
2	FRONT BASE TUBE	1
3	LOW ROW CONNECTOR	1
4	FOOT PLATE	1
5	REAR UPRIGHT	1
6	BOTTOM CROSS CONNECTOR	1
7	SIDE ROW CONNECTOR	1
8	FRONT UPRIGHT	1
9	TOP FRAME	1
10	FIXING BRACKET	1
11	REAR CONNECT	1
12	SINGLE PULLEY BLOCK	1
13	CABLE ARM ASSEMBLE	1
14	CABLE ARM	2
15	AXLE COLLAR	2
16	PRESS ARM	1
17	PRESS ARM SELECTOR	1
18	HAND GRIP (LEFT)	1
19	HAND GRIP (RIGHT)	1
20	SEAT CUSHION SUPPORT	1
21	LEG EXTENSION	1
22	CUSHION SUPPORT	1
23	ROTATIONAL PULLEY BLOCK	2
24	BACK CUSHION SUPPORT	1
25	IRON SHELL (LEFT)	1
26	IRON SHELL (RIGHT)	1
27	ADJUSTABLE PULLEY BLOCK	2
28	GUIDE ROD	2
29	SELECTOR ROD	1
30	LAT BAR	1
31	PIVOT AXLE	2

32	PULL PIN	2
33	GYRO WHEEL	2
34	BUSHING	2
35	INSERT PIN	2
36	DOUBLE - THREAD SCREW	2
37	ROUND TUBE	1
38	INTENSIFY PLATE (1)	1
39	INTENSIFY PLATE (2)	2
40	INTENSIFY PLATE (3)	1
41	PULLEY BLOCK	4
42	JOINT PLATE	3
43	BIG WASHER	2
44	IRON BUSHING	4
45	PLASTIC BUSHING	2
46	HAND GRIP OF CABLE ARM	2
47	BACK CUSHION	1
48	SEAT CUSHION	1
49	HEADREST CUSHION	1
50	WEIGHT PLATE	15
51	TOP PLATE	1
79	SQUARE END CAP - 50	7
80	BUFFER (A)	1
81	SELECTOR PIN	1
82	BUFFER (B)	4
83	STABILIZER	1
84	BUFFER (C)	2
85	YELLOW HANDLE	4
86	FAST PIN (YELLOW)	1
87	SQUARE BUSHING-45	1
88	FOAM ROLLER (WITH PU JACKET)	2
89	BIG PLUG FOR FOAM	2
90	PLASTIC BUSHING	10
90S	PLASTIC BUSHING (SHOTER THAN PART 90)	2
91	PULLEY - Ø90	29

92	PULLEY - Ø100	1
93	HOIST HOOK	4
94	HOLE PLUG	27
95	SQUARE NECK BOLT M10×60 + WASHER + LOCK NUT	6
96	BOLT M10×75 + TWO WASHERS + LOCK NUT	11
97	SQUARE NECK BOLT M10×60	2
98	BOLT M10×70 + TWO WASHERS + LOCK NUT	5
99	BOLT M10×90 + TWO WASHERS + LOCK NUT	4
100	CROSS RECESSED COUNTERSUNK HEAD SCREW M10×65 + TWO NUTS	1
101	BOLT M10×20 + WASHER	2
102	CROSS PAD HEAD SCREW M6×10	1
103	BOLT M10×65 + BIG WASHER + WASHER + LOCK NUT	2
104	CROSS RECESSED COUNTERSUNK HEAD SCREWS M10×40	1
105	BOLT M10×80 + TWO WASHERS + LOCK NUT + TWO NELON CAPS	1
106	SET SCREW M6×6	4
107	BOLT M12×20 + WASHER	4
108	TWO WASHERS 12 + TWO LOCK NUTS M12	2
110	BOLT M10×50 + TWO WASHERS + LOCK NUT	6
111	BOLT M10×85 + TWO WASHERS + LOCK NUT	1
112	BOLT M10×55 + TWO WASHERS + LOCK NUT	1
113	BOLT M10×125 + TWO WASHERS + LOCK NUT	1
114	BOLT M6×45 + TWO WASHERS + LOCK NUT	2
115	BOLT M8×16 + WASHER	18
116	BOLT M8×85 + WASHER	2
117	BOLT M6×20 + WASHER	4
118	CHAIN	1
119	CABLE WITH ONE BALL	1
120	CABLE WITH TWO BALL (PARTS OF ONE BALL)	1
121	CABLE WITH TWO BALL AND PARTS	1
122	CABLE WITH NO BALL	1
123	ROUND PLUG - Ø25	2
124	ROUND BUSHING - Ø50	2
125	OVAL PLUG - 8040	5
126	ROUND PLUG - Ø30	2

127	RECTANGLE PLUG - 7050	2
128	SQUARE PLUG - 38	2
129	SQUARE PLUG - 25	2
130	SPRING	4
131	FOAM TUBE LAT BAR	2
132	CIRCLIPS FOR SHAFT	2
148	BIG WASHER 12	1
149	CORE PULLING RIVET	12
150	WASHER 10 + LOCK NUT M10	1
151	PROTECT PAD	8
152	BOLT M10×45 + TWO WASHERS + LOCK NUT	15
154	RUBBER PLATE	2
155	CROSS SOCKET HEAD SCREWS M5×10	4
156	SQUARE NECK BOLT M10×60	8
157	WASHER 10	101
158	LOCK NUT M10	54
159	BOLT M10×75	11
160	BOLT M10×70	5
161	BOLT M10×90	4
162	CROSS RECESSED COUNTERSUNK HEAD SCREW M10×65	1
163	HEXAGON NUT M10	2
164	BOLT M10×20	2
165	CROSS PAD HEAD SCREW M6×10	1
166	BIG WASHER 10	2
167	CROSS RECESSED COUNTERSUNK HEAD SCREWS M10×40	1
168	BOLT M10×80	1
169	NELON CAP 10	2
170	SET SCREW M6×6	4
171	BOLT M12×20	4
172	WASHER 12	8
173	LOCK NUT M12	4
174	BOLT M10×50	6
175	BOLT M10×85	1
176	BOLT M10×55	1

177	BOLT M10×125	1
178	BOLT M6×45	2
179	WASHER 6	8
180	LOCK NUT M6	2
181	BOLT M8×16	18
182	WASHER 8	20
183	BOLT M8×85	2
184	BOLT M6×20	4
194	BOLT M10×65	2
195	BOLT M10×45	15
197	CROSS SOCKET HEAD SCREWS M5×10	4

7.3 Exploded Drawing

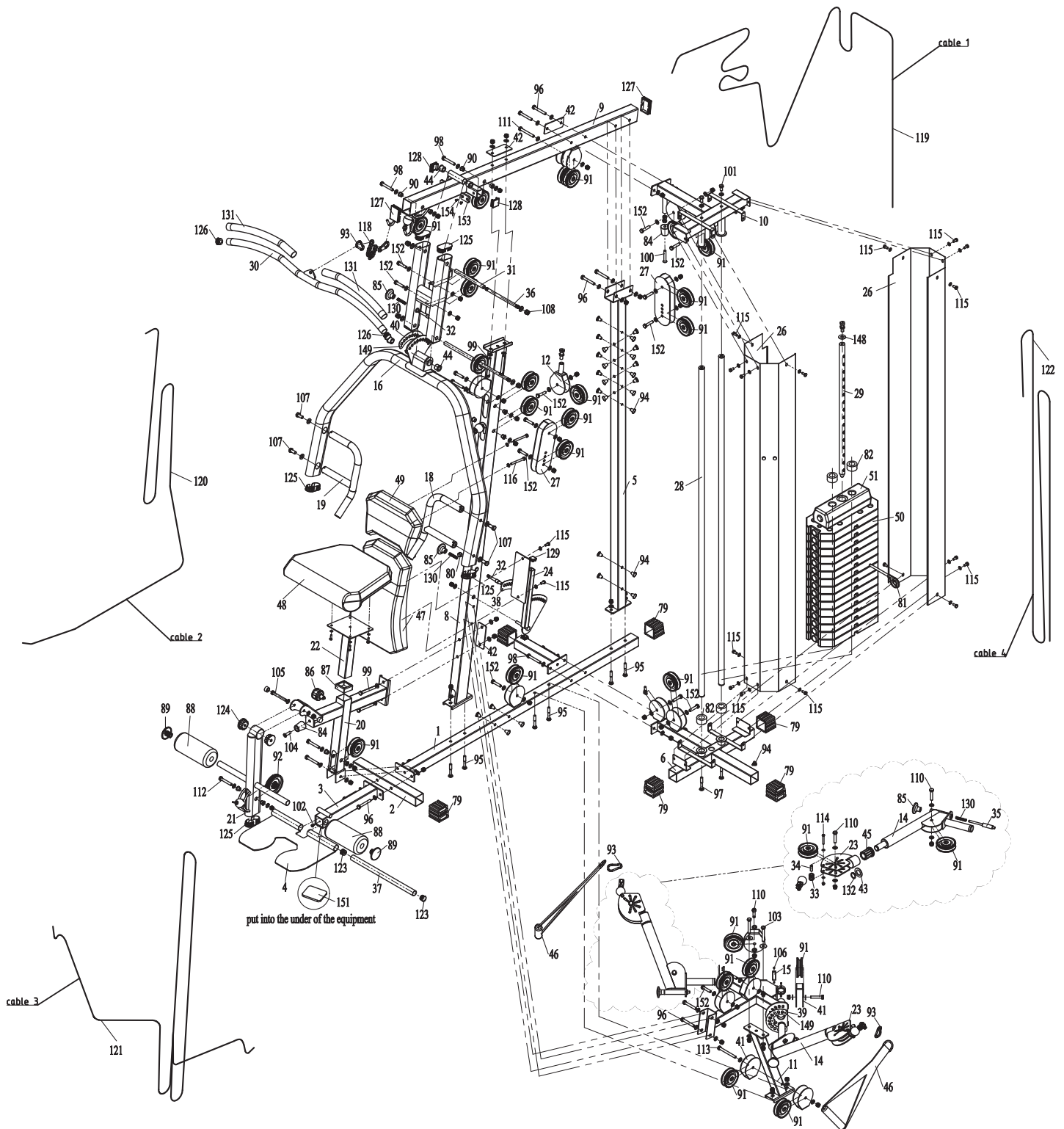

Training equipment from Taurus® is subject to strict quality control. However, if a fitness equipment purchased from us does not work perfectly, we take it very seriously and ask you to contact our customer service as indicated. We are happy to help you by phone via our service hotline.

Error Descriptions

Your fitness equipment is developed for long-term, high-quality training. However, should a problem arise, please first read the operating instructions. For further assistance, please contact your contract partner or call our service hotline. To ensure your problem is solved as quickly as possible, please describe the defect as exactly as possible.

In addition to the statutory warranty, we provide a warranty for every fitness equipment purchased from us according to the following provisions.

Your statutory rights are not affected.

Warrantee

The warrantee is the first/original buyer and/or any person who received a newly purchased product as a gift from the original buyer.

Warranty period

The warranty periods, shown on our web shop, begin on delivery of the fitness equipment. The respective warranty periods for your equipment can be found on its product website.

Repair Costs

According to our choice, there will either be a repair, a replacement of individual damaged parts or a complete replacement. Spare parts, that have to be mounted while assembling the equipment, have to be replaced by the warrantee personally and are not a part of repair. After the expiration of the warranty period for repair costs, a pure parts warranty applies, which does not include the repair, installation and delivery costs.

The terms of use are defined as follows:

- + Home use: solely for private use in private households up to 3 hours per day
- + Semi-professional use: up to 6 hours per day (e. g. rehabilitation centres, hotels, clubs, company gyms)
- + Professional use: more than 6 hours per day (e. g. commercial gyms)

Warranty Service

Within the warranty period, equipment which develops faults as a result of material or manufacturing defects, will be repaired or replaced at our discretion. Ownership of equipment or parts of equipment which have been replaced is transferred to us. The warranty period is not extended nor does a new warranty period begin following repair or replacement under the warranty.

Warranty Conditions

For the warranty to be valid, the following steps must be taken:

Please contact our customer service by email or phone. If the product under warranty has to be sent in for repair, the seller bears costs. After expiry of the warranty, the buyer bears the costs of transport and insurance. If the fault is covered by our warranty, you will receive a new or repaired equipment in return.

Warranty claims are invalid in case of damage resulting from:

- + misuse or improper handling
- + environmental influences (moisture, heat, electrical surge, dust, etc.)
- + failure to follow the current safety measures for the equipment
- + failure to follow the operating instructions
- + use of force (e. g. hitting, kicking, falling)
- + interventions which were not carried out by one of our authorized service centres
- + unauthorised repair attempts

Proof of Purchase and Serial Number

Please make sure that you are able to provide the appropriate receipt when claiming on your warranty. So that we can clearly identify the model of your equipment, and for the purposes of our quality control, you will need to give the serial number of your equipment, when contacting the service team. Where possible please have your serial number and your customer number ready when you call our service hotline. It will help us to deal with your request swiftly.

If you cannot find the serial number on your fitness equipment, our service team is at your disposal to offer further information.

Service outside of the Warranty Period

We are also happy to issue an individual cost estimate if there is a problem with your fitness equipment after the warranty has expired, or in cases which do not fall under the terms of the warranty, e. g. normal wear and tear. Please contact our customer service team to find a quick and cost-effective solution to your problem. In such a case you will be responsible for the delivery costs.

Communication

Many problems can be solved just by speaking to us as your specialist supplier. We know how important it is to you as a user of the fitness equipment to have problems solved quickly and simply, so you can enjoy working out with minimal interruption. For that reason, we also want to resolve your queries quickly and in a straightforward manner. Thus, please always keep your customer number and the serial number of the faulty equipment handy.

DE	DK	FR
<p>TECHNICAL SUPPORT</p> <p>☎ +49 4621 4210-900 ☎ +49 4621 4210-698 ✉ technik@sport-tiedje.de 🕒 Mo - Fr 08:00 - 18:00 Sa 09:00 - 18:00</p> <p>SERVICE</p> <p>☎ 0800 20 20277 (Freecall) ✉ info@sport-tiedje.de 🕒 Mo - Fr 08:00 - 21:00 Sa 09:00 - 21:00 So 10:00 - 18:00</p>	<p>TECHNICAL SUPPORT & SERVICE</p> <p>☎ 80 90 16 50 +49 4621 4210-945 ✉ info@fitshop.dk 🕒 Mo - Fr 08:00 - 18:00 Sa 09:00 - 18:00</p>	<p>TECHNICAL SUPPORT & SERVICE</p> <p>☎ +33 (0) 172 770033 +49 4621 4210-933 ✉ service-france@fitshop.fr 🕒 Mo - Fr 08:00 - 18:00 Sa 09:00 - 18:00</p>
	PL	BE
	<p>TECHNICAL SUPPORT & SERVICE</p> <p>☎ 22 307 43 21 +49 4621 42 10-948 ✉ info@fitshop.pl 🕒 Mo - Fr 08:00 - 18:00 Sa 09:00 - 18:00</p>	<p>TECHNICAL SUPPORT & SERVICE</p> <p>☎ 02 732 46 77 +49 4621 42 10-932 ✉ info@fitshop.be 🕒 Mo - Fr 08:00 - 18:00 Sa 09:00 - 18:00</p>

UK	NL	INT
<p>TECHNICAL SUPPORT</p> <p>☎ +44 141 876 3986 ✉ support@powerhousefitness.co.uk</p> <p>SERVICE</p> <p>☎ +44 141 876 3972 🕒 Mo - Fr 9am - 5pm</p>	<p>TECHNICAL SUPPORT & SERVICE</p> <p>☎ +31 172 619961 ✉ info@fitshop.nl 🕒 Ma - Do 09:00 - 17:00 Vr 09:00 - 21:00 Za 10:00 - 17:00</p>	<p>TECHNICAL SUPPORT & SERVICE</p> <p>☎ +49 4621 4210-944 ✉ service-int@sport-tiedje.de 🕒 Mo - Fr 8am - 6pm Sat 9am - 6pm</p>
	AT	CH
	<p>TECHNICAL SUPPORT & SERVICE</p> <p>☎ 0800 20 20277 (Freecall) +49 4621 42 10-0 ✉ info@sport-tiedje.at 🕒 Mo - Fr 08:00 - 18:00 Sa 09:00 - 18:00</p>	<p>TECHNICAL SUPPORT & SERVICE</p> <p>☎ 0800 202 027 +49 4621 42 10-0 ✉ info@sport-tiedje.ch 🕒 Mo - Fr 08:00 - 18:00 Sa 09:00 - 18:00</p>

Please find a detailed overview including address and opening hours for all stores of the Sport-Tiedje Group in Germany and abroad on the following website:

www.sport-tiedje.com/en/stores

WE LIVE FITNESS

WEBSHOP AND SOCIAL MEDIA

Sport-Tiedje is Europe's largest specialist store for home fitness equipment with currently 80 stores and one of the world's most renowned online mail order companies for fitness equipment. Private customers order via the 25 web shops in the respective national language or have their desired equipment assembled on site. In addition, the company supplies fitness studios, hotels, sports clubs, companies and physio practices with professional equipment for endurance and strength training.

Sport-Tiedje offers a wide range of fitness equipment from renowned manufacturers, high-quality in-house developments and comprehensive services, such as a build-up service and sports scientific advice before and after the purchase. The company employs numerous sports scientists, fitness trainers and competitive athletes.

Visit us also on our social media platforms or our blog!

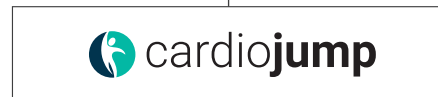
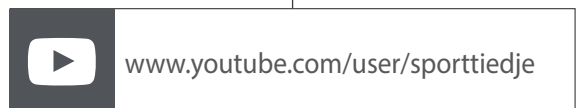
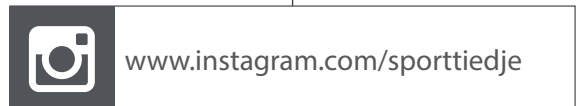

Notes

TAURUS[®]