

TAURUS®

Assembly and Operating Instructions

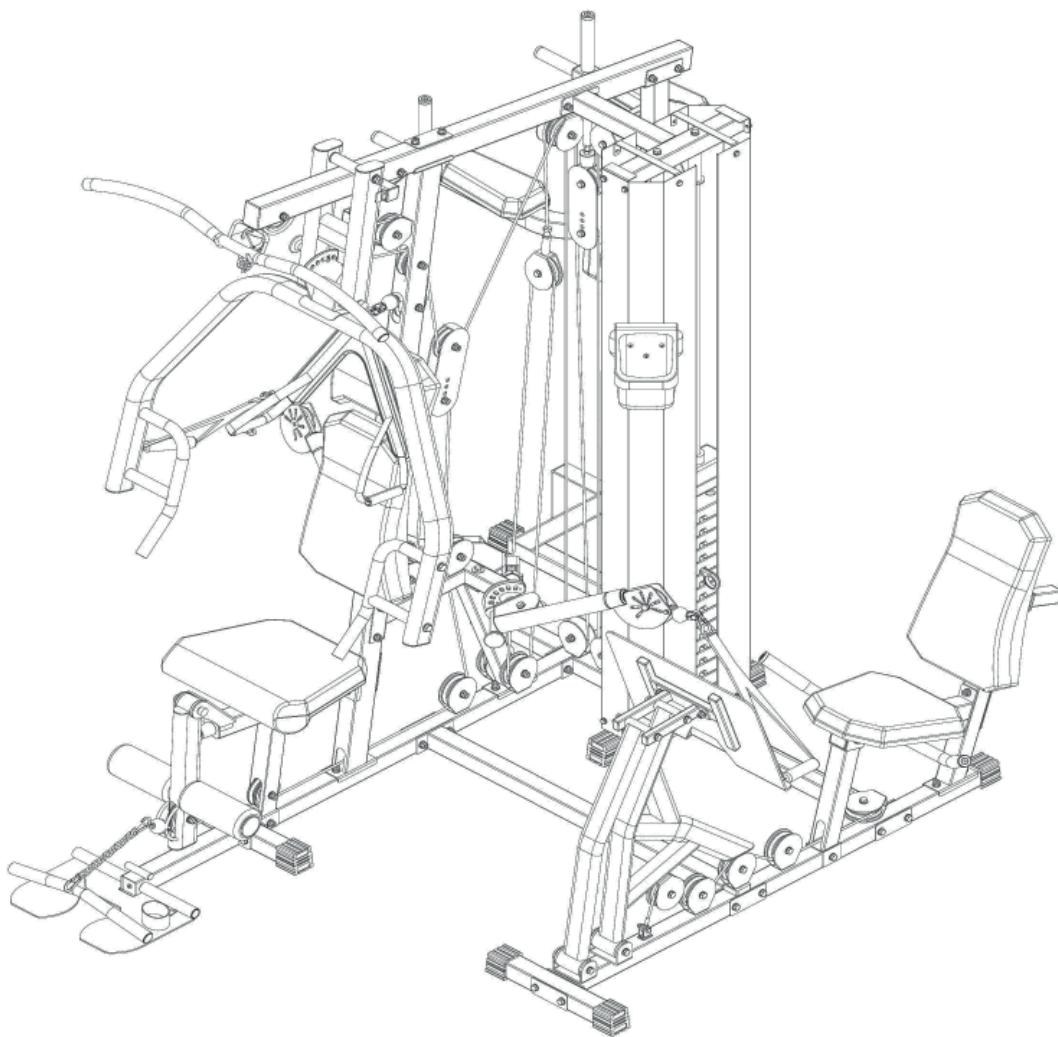

max. 150 kg



~ 240 Min.



247 kg

L 236 | W 203 | H 205

FSTFW55.06.01

Art. No. TF-WS5-6

Multi-gym WS5

Content

1	GENERAL INFORMATION	8
1.1	Technical Data	8
1.2	Personal Safety	9
1.3	Set-Up Place	10
2	ASSEMBLY	11
2.1	General Instructions	11
2.2	Assembly Part A	12
2.2.1	Scope of Delivery	12
2.2.2	Assembly	16
2.3	Assembly Part B	36
2.3.1	Scope of Delivery	36
2.3.2	Assembly	38
2.4	Assembly Part C	48
2.4.1	Scope of Delivery	48
2.4.2	Assembly	48
2.5	Assembly Part D	51
2.5.1	Scope of Delivery	51
2.5.2	Assembly	52
2.6	Cable Installation Overview	54
2.6.1	Part A	54
2.6.2	Part B	55
3	STORAGE AND TRANSPORT	56
3.1	General Instructions	56
4	TROUBLESHOOTING, CARE AND MAINTENANCE	57
4.1	General Instructions	57
4.2	Faults and Fault Diagnosis	57
4.3	Maintenance and Inspection Calendar	58
5	DISPOSAL	58
6	RECOMMENDED ACCESSORIES	59

7	ORDERING SPARE PARTS	60
7.1	Serial Number and Model Name	60
7.2	Parts List Part A	61
7.3	Exploded Drawing Part A	66
7.4	Parts List Part B	67
7.5	Exploded Drawing Part B	69
7.6	Parts List Part C	70
7.7	Exploded Drawing Part C	71
7.8	Parts List Part D	72
7.9	Exploded Drawing Part D	73
8	WARRANTY	74
9	CONTACT	76

Dear customer,

Thank you for choosing quality training equipment from the TAURUS® brand. Taurus offers sports and fitness equipment for home users with high demands on quality, functionality and longevity. Also, Taurus is a well-known and experienced brand for equipping professional rooms for fitness studios and business customers. The focus of Taurus fitness equipment is on what matters most in sports: maximum performance! Therefore, the devices are developed in close consultation with athletes and sports scientists. Because athletes know best what makes perfect fitness equipment.

Further information can be found at www.fitshop.com.

Intended Use

The equipment may only be used for its intended purpose.

The equipment is only suitable for home use. The equipment is not suitable for semi-professional (e.g. hospitals, associations, hotels, schools, etc.) and commercial or professional use (e.g. fitness studios).

Legal Notice

Fitshop GmbH
Europe's No. 1 for home fitness

International Headquarters
Flensburger Straße 55
24837 Schleswig
Germany

Management:
Christian Grau
Sebastian Campmann
Dr. Bernhard Schenkel
No. HRB 1000 SL
Local Court Flensburg
European VAT Number: DE813211547

Disclaimer

© TAURUS is a registered brand of the company Fitshop GmbH. All rights reserved. Any use of this trademark without the explicit written permission of Fitshop is prohibited.

Product and manual are subject to change. Technical data can be changed without advance notice.

FITSHOP

Europe's No.1 for Home Fitness

ABOUT THIS MANUAL

Please carefully read the entire manual before installation and first use. The manual will help you to quickly set up the system and explains how to safely use it. Make sure that all persons exercising with the equipment (especially children and persons with physical, sensory, mental or motor disabilities) are informed about this manual and its contents in advance. In case of doubt, responsible persons must supervise the use of the equipment.

Due to ongoing changes and software optimisations, the manual may have to be updated. If you notice any discrepancies during assembly or use, please refer to the manual uploaded to the webshop. The latest manual is always available there.



This equipment has been manufactured according to the latest safety knowledge. As far as possible, potential safety hazards which could cause injury have been eliminated. Make sure to carefully follow the instructions and that all parts are securely in place. If required, read through the instructions again to correct any mistakes.

Training devices must be classified according to accuracy and use. Accuracy classes are only applicable to devices that display training data.

Accuracy classes

Class A: high accuracy.

Class B: medium accuracy.

Class C: low accuracy.

The use classes explain the intended use of the training device.

Use classes

Class S (studio): professional and/or commercial use.

These training devices are intended for the use in training rooms of facilities such as sports clubs, school facilities, hotels, clubs and studios whose access and supervision is specifically regulated by the owner (person with legal responsibility).

Class H (home use): use at home.

These stationary training devices are intended for the use in private homes where access to the training device is regulated by the owner (person with legal responsibility).

Please pay close attention to the safety and maintenance instructions given here. The contract partner cannot be held liable for damage to health, accidents or damage to the equipment when it is not used in accordance with these instructions.

The following safety instructions may appear in this manual:

► **ATTENTION**

This notice indicates potentially hazardous situations which, if not avoided, may result in property damage.

⚠ **CAUTION**

This notice indicates potentially hazardous situations which, if not avoided, may result in slight or minor injuries!

⚠ **WARNING**

This notice indicates potentially hazardous situations which, if not avoided, may result in death or serious injuries!

⚠ **DANGER**

This notice indicates potentially hazardous situations which, if not avoided, will result in death or serious injuries!

ⓘ **NOTICE**

This notice indicates further useful information.

Retain these instructions in a safe place for future reference, maintenance or when ordering replacement parts.

1.1 Technical Data

Gewicht und Maße:

Artikelgewicht (brutto, inkl. Verpackung): 511,5 kg
Artikelgewicht (netto, ohne Verpackung): 247 kg

Verpackungsmaße Kartons (LxBxH):

Nr. 1	ca. 194 cm x 32 cm x 24 cm
Nr. 2	ca. 163 cm x 32 cm x 24 cm
Nr. 3	ca. 120 cm x 59 cm x 24 cm
Nr. 4	ca. 111 cm x 101 cm x 18 cm
Nr. 5	ca. 40 cm x 20 cm x 23 cm
Nr. 6	ca. 40 cm x 20 cm x 23 cm
Nr. 7	ca. 40 cm x 20 cm x 31 cm
Nr. 8	ca. 146 cm x 29 cm x 18 cm
Nr. 9	ca. 77 cm x 60 cm x 16 cm
Nr. 10	ca. 75 cm x 51 cm x 21 cm
Nr. 11	ca. 49 cm x 20 cm x 12 cm

Aufstellmaße (LxBxH): ca. 236 cm x 203 cm x 205 cm

Maximales Benutzergewicht: 150 kg

Use class: H

1.2 Personal Safety

DANGER

- + Before you start using the equipment, you should consult your physician that this type of exercise is suitable for you from a health perspective. Particularly affected are persons who: have a hereditary disposition to high blood pressure or heart disease, are over the age of 45, smoke, have high cholesterol values, are overweight and/or have not exercised regularly in the past year. If you are under medical treatment that affects your heart rate, medical advice is absolutely essential.
- + Note that excessive training can seriously endanger your health. Please also note that heart rate monitoring systems can be inaccurate. If you notice any signs of weakness, nausea, dizziness, pain, shortness of breath, or other abnormal symptoms, stop exercising immediately and seek advice from your doctor if necessary.
- + The owner must communicate all warnings and instructions to the user.

WARNING

- + This equipment may not be used by children under the age of 14.
- + Children should not be allowed unsupervised access to the equipment.
- + Persons with disabilities must have a medical license and must be under strict observation when using the equipment.
- + The equipment is strictly for use by one person at a time.
- + Keep your hands, feet and other body parts, hair, clothing, jewellery and other objects well clear of moving parts.
- + During use, wear suitable sports clothing rather than loose or baggy clothing. When wearing sports shoes, make sure they have suitable soles, preferably made of rubber or other non-slip materials. Shoes with heels, leather soles, studs or spikes are unsuitable. Never exercise barefoot.
- + Always start each workout with a light warm-up and end with a cool-down phase.
- + Using the machine as a support during stretching exercises or attaching resistance bands, ropes or other accessories to it, may cause injuries.

CAUTION

- + If your equipment needs to be connected to the power supply with a mains cable, make sure that the cable is not a potential tripping hazard.
- + Make sure that nobody is within the range of motion of the equipment during training so as not to endanger you or other persons.
- + Be aware that if adjustment devices are left protruding, they may impede the user's movement.
- + The weights should remain in the user's field of vision during the entire exercise to prevent danger to third parties.

ATTENTION

- + Do not insert any objects of any kind into the openings of the device.

1.3 Set-Up Place

WARNING

- + Do not place the equipment in main corridors or escape routes.

CAUTION

- + Choose a location in which to place the equipment such that there is enough free space/clearance to the front, the rear and to the sides of the equipment.
- + The training room should be well ventilated during training and not be exposed to any draughts.
- + Choose the place in which to set up the equipment such that there is enough free space/clearance to the front, the rear and to the sides of the equipment.
- + The free area in the direction from which the exercise equipment is accessed must be at least 0.6 m larger than the exercise area.
- + The set-up and mounting surface of the equipment should be flat, loadable and solid.
- + If your device is to be mounted on the wall/ceiling, make sure that you use the appropriate assembly material to avoid possible damages or personal injuries. The contractual partner accepts no liability for this.

ATTENTION

- + The device may only be used in one building, in sufficiently tempered and dry rooms (ambient temperatures between 10°C and 35°C). The equipment should not be used outdoors or in rooms with high humidity (over 70%) like swimming pools.
- + A floor protective mat/equipment underlay can help to protect high-quality floor coverings (parquet, laminate, cork, carpets) from dents and sweat and can help to level out slight unevenness.
- + For Class S equipment, the exercise equipment may only be used in areas where access, supervision and control are specifically regulated by the owner.

2.1 General Instructions



DANGER

- + Do not leave any tools, packaging materials such as foils or small parts lying around, as otherwise there is a danger of suffocation for children. Keep children away from the equipment during assembly.



WARNING

- + Pay attention to the instructions attached to the equipment in order to reduce the risk of injuries.



CAUTION

- + Ensure to have sufficient room for movement in each direction during assembly.
- + The assembly of the equipment must be carried out by at least two adults. If in doubt, seek the help of a third technically skilled person.



ATTENTION

- + To prevent damage to the equipment and the floor, assemble the equipment on a mat or packaging board.



NOTICE

- + In order to make the assembly as simple as possible, some screws and nuts to be used can already be pre-assembled.
- + Ideally, assemble the equipment at its later set-up place.

2.2 Assembly Part A











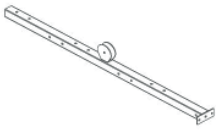
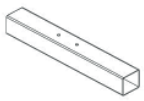
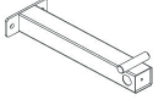

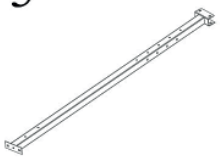
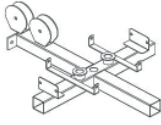

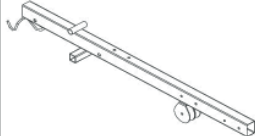
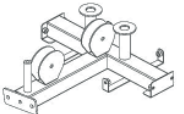
2.2.1 Scope of Delivery

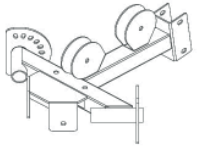

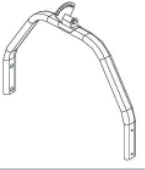
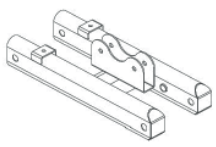

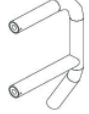
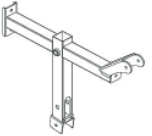
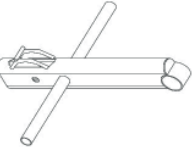
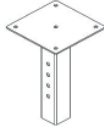

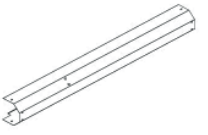
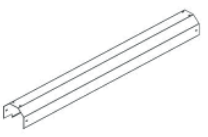

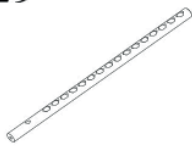
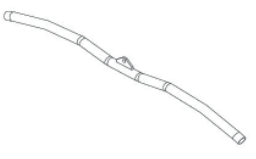

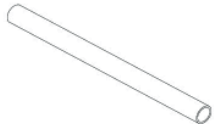

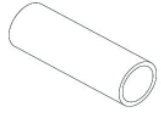





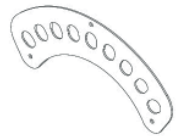

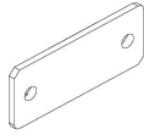



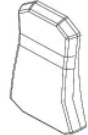
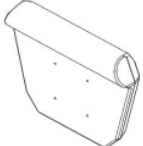

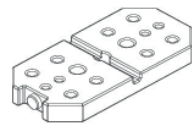
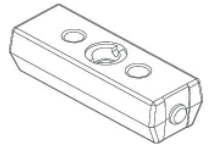
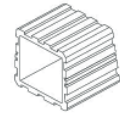
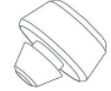
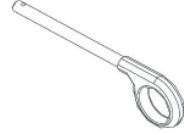

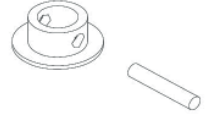

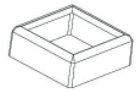
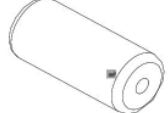

The scope of delivery consist of the following parts. At the beginning, check whether all parts and tools belonging to the device are included in the scope of delivery and whether damage has occurred. In the event of complaints, the contractual partner must be contacted directly.













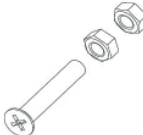











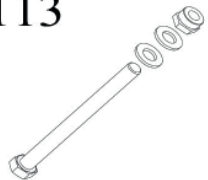





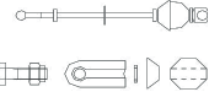







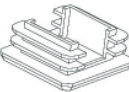

CAUTION

If parts of the scope of delivery are missing or damaged, the assembly must not be carried out.

1 	2 	3 	4 	5 
6 	7 	8 	9 	10 
11 	12 	13 	14 	15 
16 	17 	18 	19 	20 
21 	22 	23 	24 	25 
26 	27 	28 	29 	30 

31 	32 	33 	34 	35 	
36 	37 	38 	39 	40 	
41 	42 	43 	44 	45 	
46 	47 	48 	49 	50 	
51 	79 	80 	81 	82 	
83 	84 	85 	86 	87 	
88 	89 	90 	90S 	91 	92 
93 	94 	95 	96 	97 	

98 	99 	100 	101 	102 
103 	104 	105 	106 	107 
108 	110 	111 	112 	113 
114 	115 	116 	117 	118 
119 	120 	121 	122 	123 
124 	125 	126 	127 	128 
129 	130 	131 	132 	148 
149 	150 	151 	152 	154 
155 				

2.2.2 Assembly

Before assembly, take a close look at the individual assembly steps shown and carry out the assembly in the order given.

ⓘ NOTICE

- + First loosely screw all parts together and check that they fit properly. Tighten the screws using the tool only when you are instructed to do so.
- + If you have difficulty recognising the graphics, we recommend that you open and/or download the PDF instructions stored in the webshop on your end device (e.g. smartphone, tablet or PC). There you have the option of zooming in closer. Please note that the Adobe Acrobat Reader programme must be installed on your end device in order to open the file.

Step 1

1. Place the end caps (79) onto the base frame (1), the bottom cross connector (6) and the side row connector (7).
2. Screw two bolts (97) into the bottom side of the bottom cross connector (6).
3. Mount the bottom cross connector (6) and the side row connector (7) to the base frame (1) with two bolt sets (96).
4. Mount the front upright frame (A8) to the base frame (1) with two bolt sets (95).
5. Mount the rear connector (11) to the base frame (1) with two bolt sets (95).
6. Mount the rear upright frame (5) to the base frame (1) with two bolt sets (95).
7. Tighten all bolts with the tool.

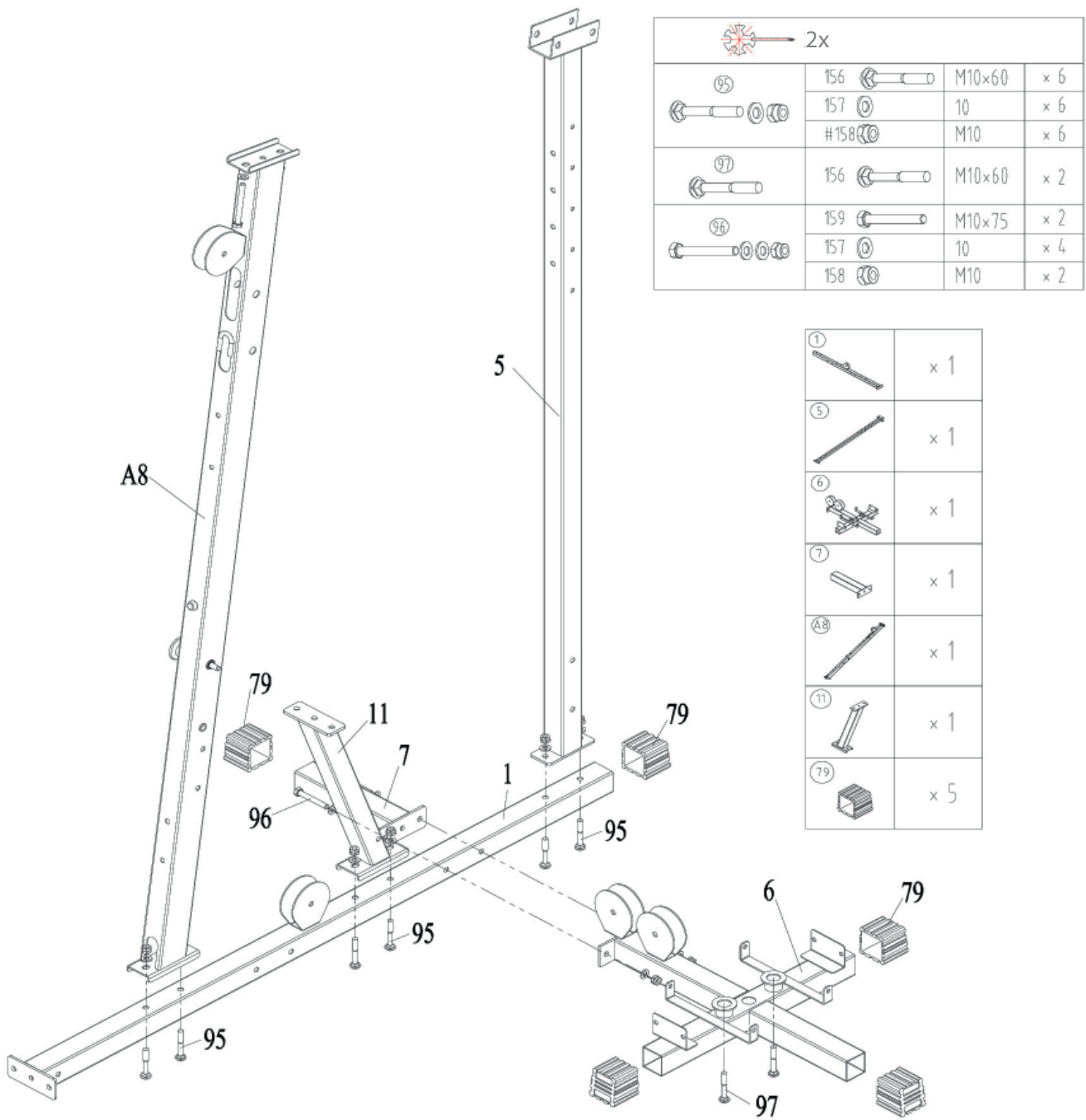

→ 2x			
	156		M10×60 × 6
	157		10 × 6
	#158		M10 × 6
	156		M10×60 × 2
	159		M10×75 × 2
	157		10 × 4
	158		M10 × 2

	× 1
	× 1
	× 1
	× 1
	× 1
	× 1
	× 5

Step 2

1. Mount the top frame (9) to the rear upright frame (5) with two bolt sets (96).
2. Mount the joint plate (42) and the top frame (A9) to the front upright frame (A8) with two bolt sets (99)..
3. Tighten all bolts with the tool.

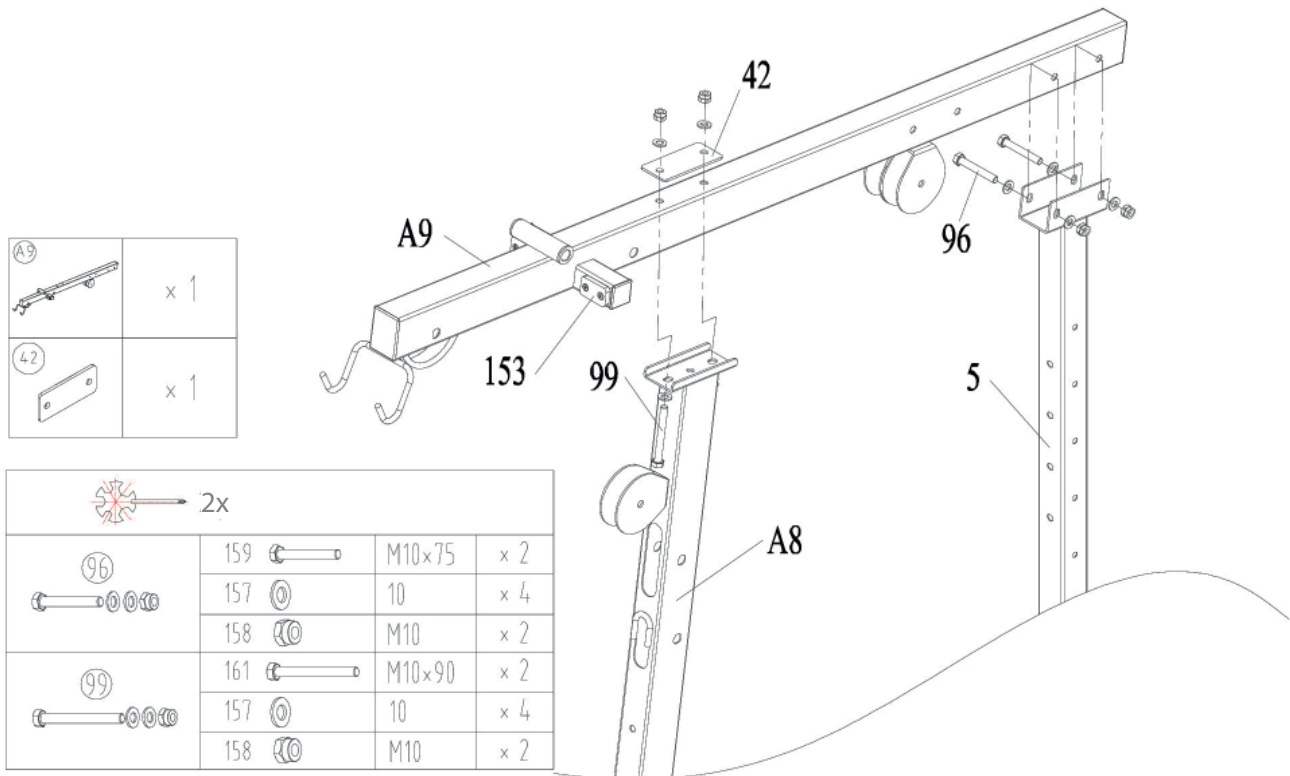

Step 3







1. Screw both guide rods (28) onto the bottom cross connector (6).
2. Shove one buffer (82) over each guide rod (28).
3. Place the plates of the weight stack (50) onto the guide bars (28) one by one.
4. Mount the top plate (51) with the stabilizer (83) to the selector rod (29).
5. Put the selector rod (29) over the guide rods (28) into the slot of the weight stack plates (50).
6. Place one buffer (82) onto each guide rod (28).

NOTICE

Two buffers (82) should be installed at the end under the weight stack plates (50) and two buffers (82) above the top plate (51).

7. Insert the selector pin (81) into the slots of the weight plates (50).

		x 1
-----------------------------------------------------------------------------------	-----------------------------------------------------------------------------------	-----



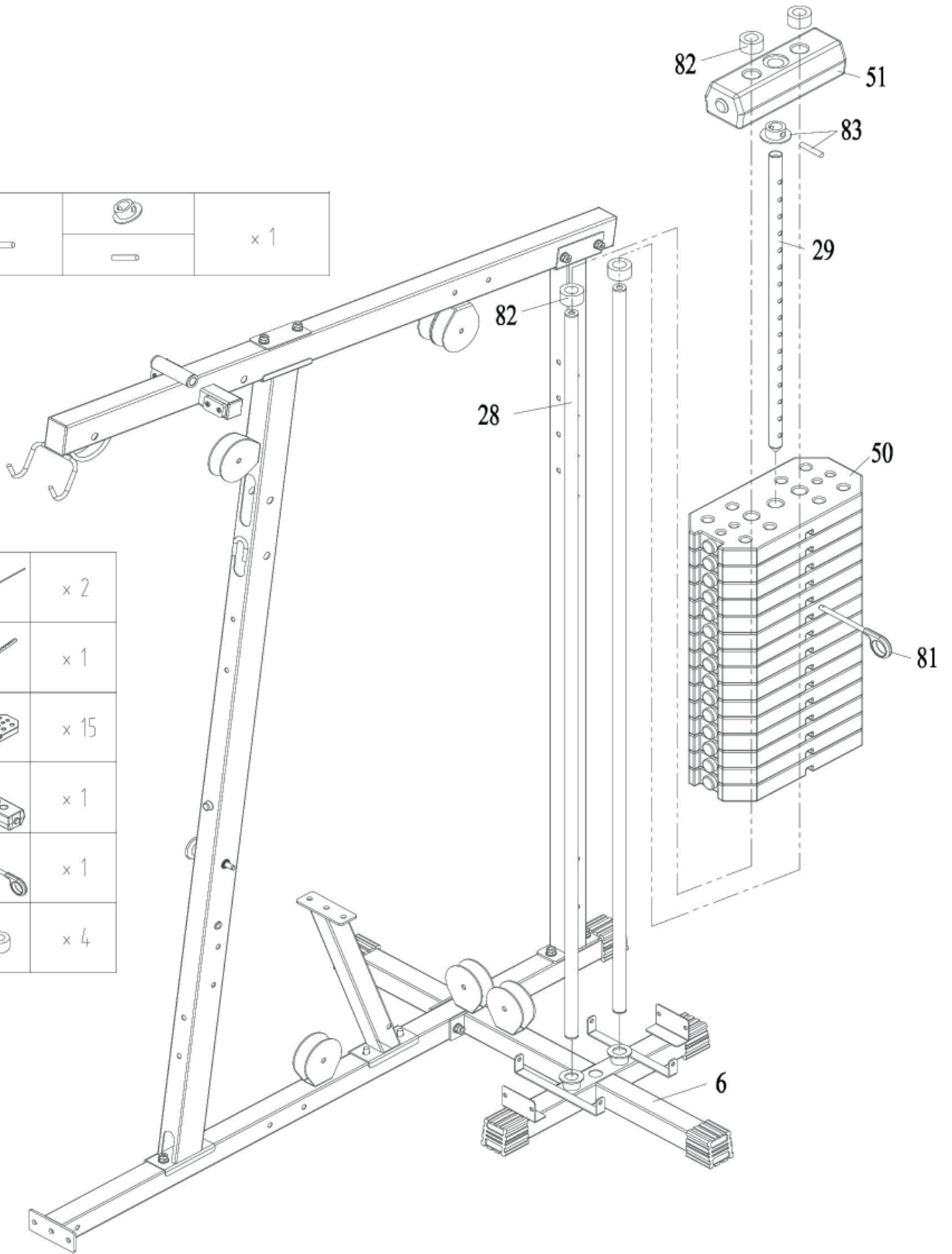





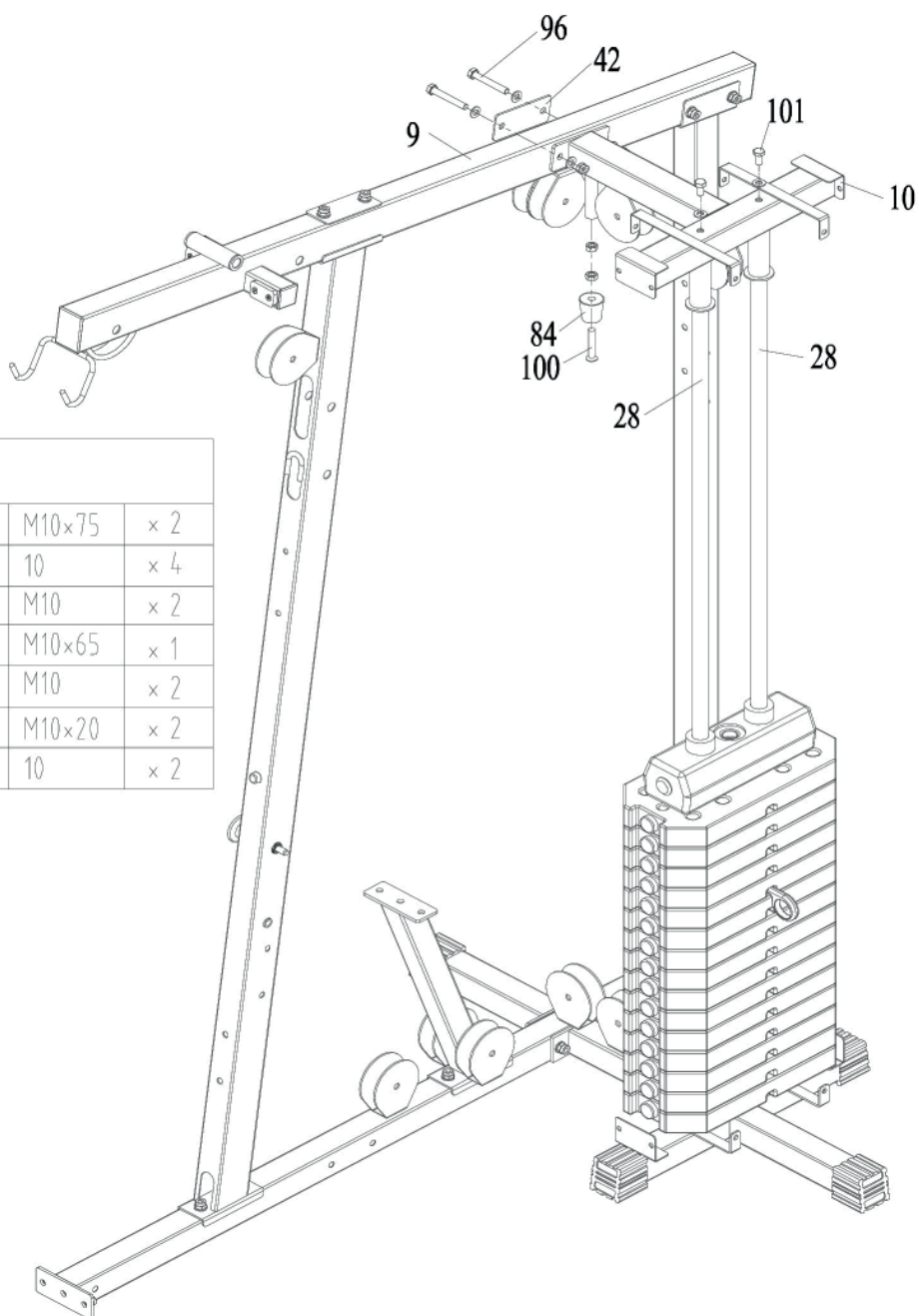

	x 2
	x 1
	x 15
	x 1
	x 1
	x 4



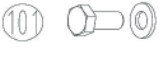

Step 4

1. Mount the fixing bracket (10) to the guide rods (28) with two bolt sets (101).
2. Mount the joint plate (42) and the fixing bracket (10) to the top frame (9) with two bolt sets (96).
3. Mount the buffer (84) to the fixing bracket (10) with one bolt set (100).
4. Tighten all bolts with the tool.



	2x		
	159		M10x75 x 2
	157		10 x 4
	158		M10 x 2
	162		M10x65 x 1
	163		M10 x 2
	164		M10x20 x 2
	157		10 x 2

	x 1
	x 1
	x 1





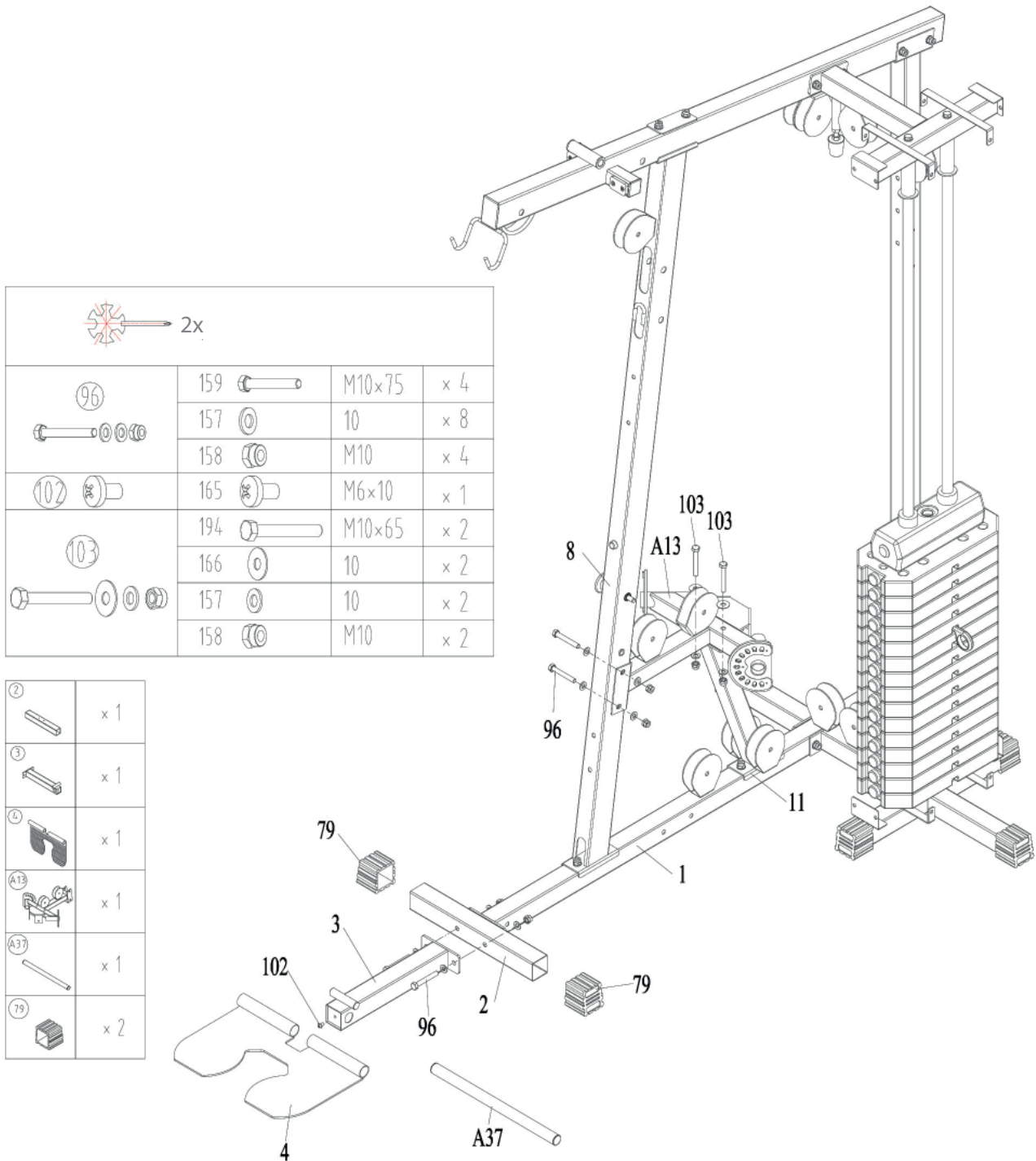











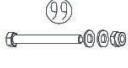





Step 5

1. Mount the cable arm assemble (A13) to the rear connector (11) with two bolt sets (103).
2. Screw the cable arm assemble (A13) to the front upright frame (A8) with two bolt sets (96).
3. Place the end caps (79) onto the front base tube (2).
4. Mount the low row connector (3) and the front base tube (2) to the base frame (1) with two bolt sets (96).
5. Mount the foot plate (4) to the low row connector (3) and insert the round tube (A37). Secure the connection with a screw (102).
6. Tighten all bolts with the tool.









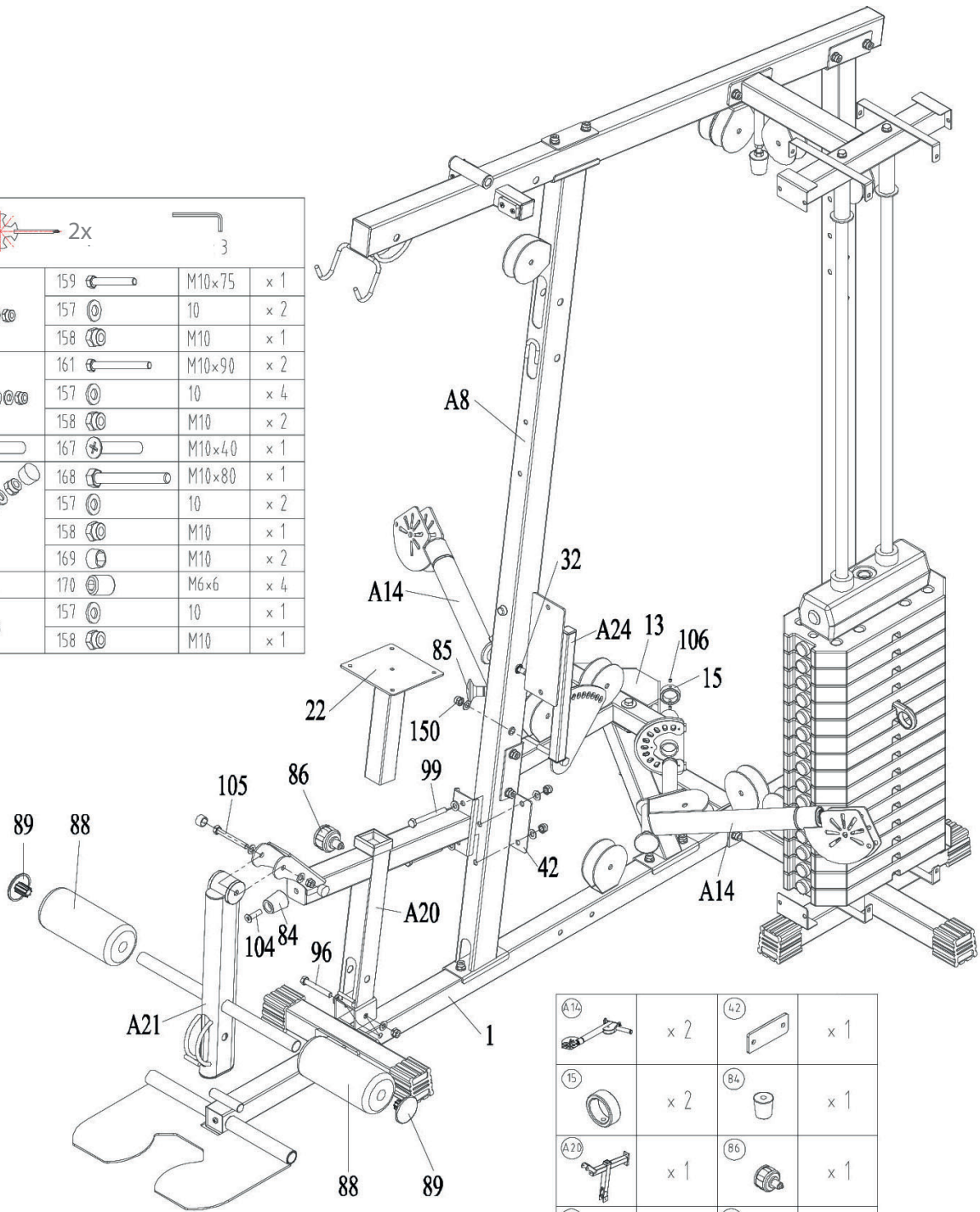



Step 6

1. Mount the seat cushion support (A20) to the base frame (1) with one bolt set (96).
2. Insert the cushion support (22) into the seat cushion support (A20) and secure the connection with the fast pin (86).
3. Mount the seat cushion support (A20) and the joint plate (42) to the front upright frame (8) with two bolt sets (99).
4. Mount the buffer (84) to the seat cushion support (A20) with a screw (104).
5. Mount the leg extension (21) to the cushion support (A20) with one bolt set (105).
6. Shove the foam roller (88) over the ends of the leg extension (21) and secure them with one plug (89) on each side.
7. Mount the back cushion support (A24) to the front upright frame (8) with one bolt set (150).
8. Mount both cable arms (A14) to the cable arm assemble (A13), place the axle collars (15) on both cable arms (A14) and secure each with two bolts (106).
9. Tighten all bolts with the tool.









	→ 2x		3
	159 	M10x75	x 1
	157 	10	x 2
	158 	M10	x 1
	161 	M10x90	x 2
	157 	10	x 4
	158 	M10	x 2
	167 	M10x40	x 1
	168 	M10x80	x 1
	157 	10	x 2
	158 	M10	x 1
	169 	M10	x 2
	170 	M6x6	x 4
	157 	10	x 1
	158 	M10	x 1









	x 2		x 1
	x 2		x 1
	x 1		x 1
	x 1		x 2
	x 1		x 2
	x 1		

Step 7

1. Mount the press arm selector (A17) to the top frame (A9) and guide the pivot axle (31) through. Insert a screw (36) into the pivot axle (31) and secure it with a nut set (108).
2. Mount the press arm (A16) to the press arm selector (A17) and guide the pivot axle (31) through.
3. Insert a screw (36) into the pivot axle (31) and secure it with a nut set (108).
4. Mount the left hand grip (18) to the left side of the press arm (A16) with two bolt sets (107).
5. Mount the right hand grip (18) to the right side of the press arm (A16) with two bolt sets (107).
6. Tighten all bolts with the tool.

			
	171 	M12x20	x 4
	172 	12	x 4
	172 	12	x 4
	173 	M12	x 4

	x 1
	x 1
	x 1
	x 1
	x 2
	x 2

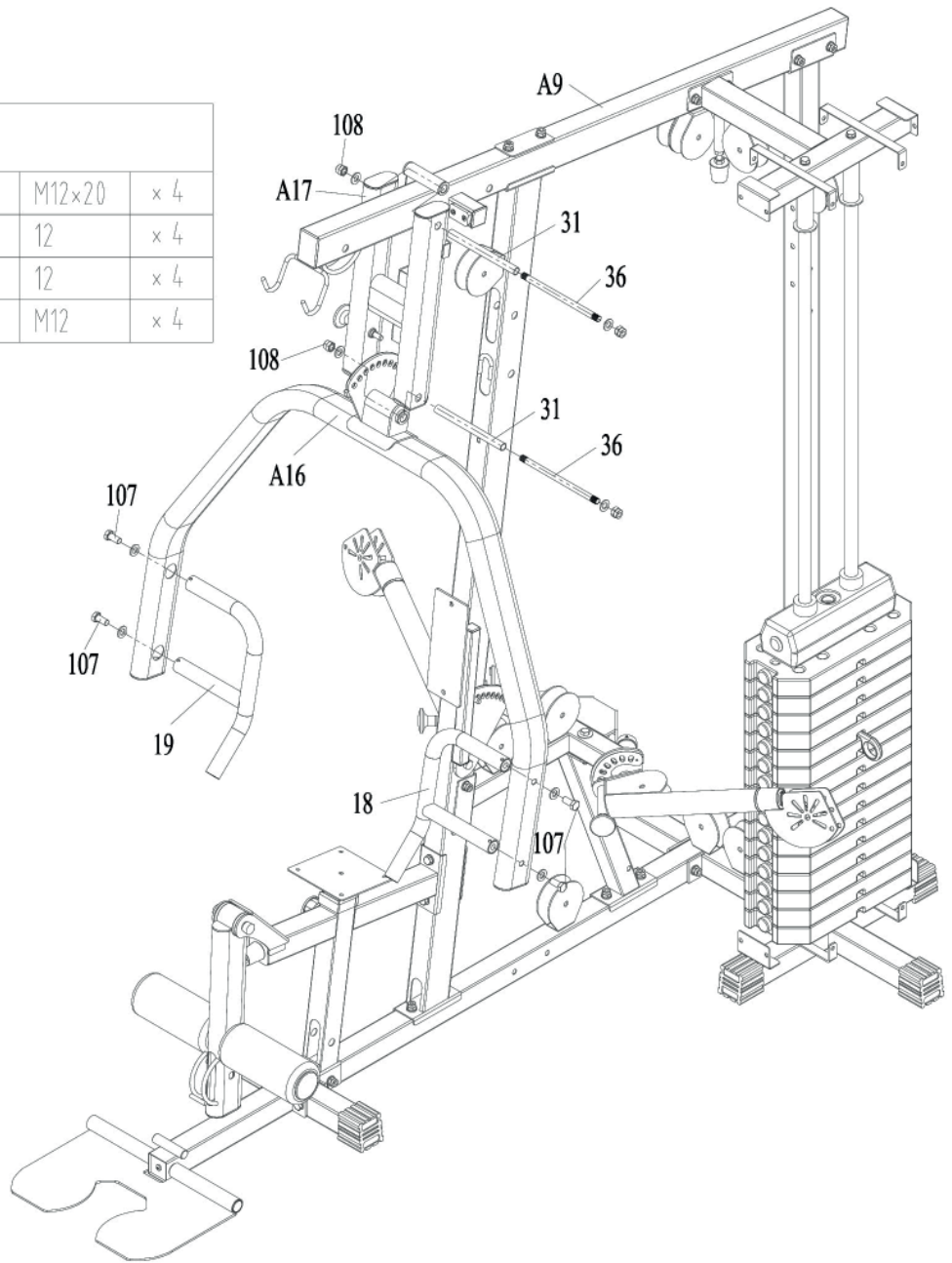

Step 8

1. Figure A: Place the two plastic bushings (90) into the top frame (9). Place cable 1 (119) on pulley P1 (91). Mount pulley P1 (91) to the top frame (9) with one bolt set (98).
2. Figure B: Place two plastic bushings (90) into the top frame (9). Place cable 1 (119) on pulley P2 (91). Mount the pulley P2 (91) to the top frame (9) with one bolt set (98).
3. Figure C: Guide cable 1 (119) over pulley P3 (91) through the left side downwards and mount the pulley P3 (91) to the back of the press arm selector (17) with one bolt set (152). Guide cable 1 (119) underneath pulley P3 (91) right over pulley P5 (91) downwards. Mount pulley P5 (91) to the front upright frame (8) with one bolt set (152). Guide cable 1 (119) over pulley P4 (91) coming from underneath of pulley P5 (91) through the left side downwards. Mount pulley P4 (91) to the back of the press arm selector (17) with one bolt set (152).
4. Figure D: Place two plastic bushings (90) into the front upright frame (8). Mount pulley P6 (91) to the front upright frame (8) with one bolt set (98). Guide cable 1 (119) over pulley P6 (91) coming from underneath of pulley P4 (91) through the front upright frame (8).
5. Figure E: Place cable 1 (119) on pulley P8 (91). Mount pulley P28 (91) and pulley P8 (91) to the top frame (9) with one bolt set (111).
6. Figure F: Place cable 1 (119) on pulley P10 (91). Mount pulley P10 (91) to the fixing bracket (10) with a bolt set (152).
7. Figure G: Place cable 1 (119) on pulley P11 (91). Mount pulley P11 (91) to the fixing bracket (10) with a bolt set (152).
8. Figure H: Mount cable 1 (119) with a big washer (148) to the selector rod (29).
9. Figure I: Mount pulley P7 (91) to the adjustable pulley block (27) with one bolt set (152). Place the adjustable pulley block (27) on cable 1 (119).
10. Figure J: Mount pulley P9 (91) to the adjustable pulley block (27) with one bolt set (152). Place the adjustable pulley block (27) on cable 1 (119).
11. Tighten all bolts with the tool.

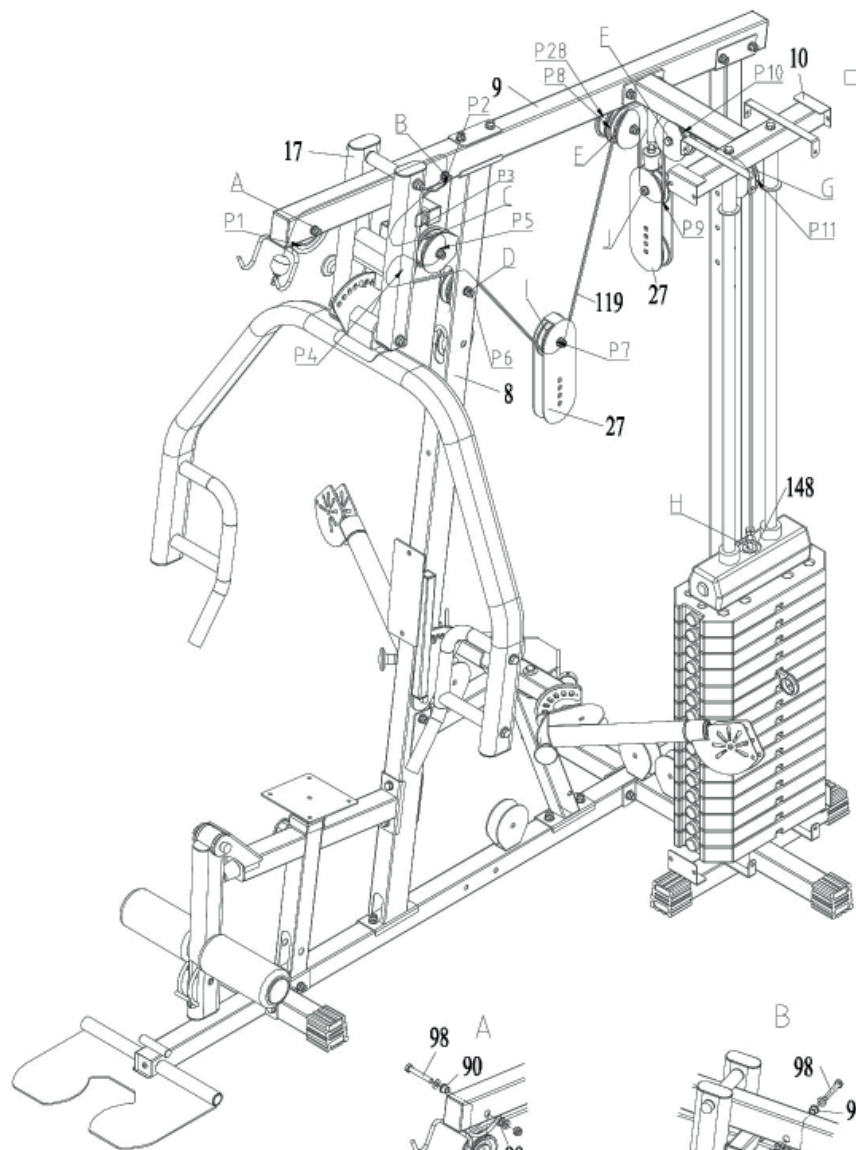

2x			
	160		M10×70 × 3
	157		10 × 6
	158		M10 × 3
	195		M10×45 × 7
	157		10 × 14
	158		M10 × 7
	175		M10×85 × 1
	157		10 × 2
	158		M10 × 1
			× 6
			× 1

	× 2
	× 12
L=420	× 1

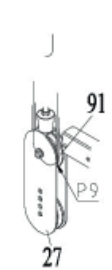
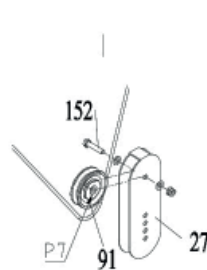
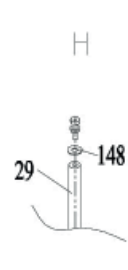
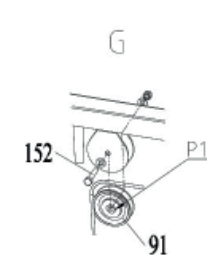
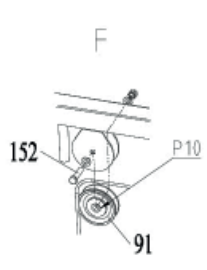
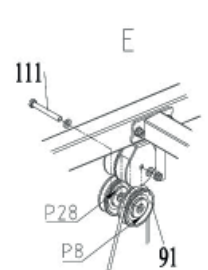
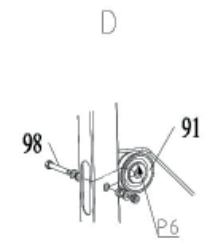
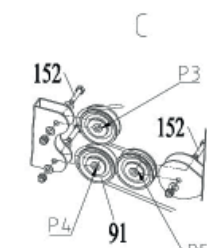
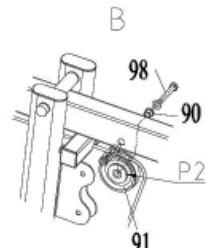
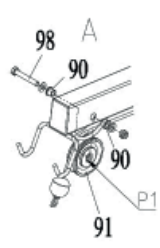

Step 9

1. Figure A: Place two plastic bushings (90S) into the leg extension (A21). Place cable 2 (120) on the $\text{\O}100$ pulley P12 (92). Mount the $\text{\O}100$ pulley P12 (92) to the leg extension (A21) with one bolt set (112).
2. Figure B: Place two plastic bushings (90) into the seat cushion support (A20). Place the pulley P13 (91) on cable 2 (120) and mount the pulley P13 (91) to the seat cushion support (A20) with one bolt set (98).
3. Figure C: Guide cable 2 (120) through the pulley holder on the base frame (1) and mount pulley P14 (91) with one bolt set (152).
4. Figure D: Guide cable 2 (120) upwards through the pulley holder on the cable arm assemble (A13) and mount pulley P15 (91) to the pulley holder with one bolt set (152).
5. Figure E: Mount pulley P16 (91) to the adjustable pulley block (27) with one bolt set (152). Guide cable 2 (120) coming from below over pulley P16 (91).
6. Figure F: Mount pulley P17 (91) to the pulley holder on the cable arm assemble (A13) with one bolt set (152). Guide cable 2 (120) coming from above along underneath pulley P17 (91).
7. Figure G and H: Guide cable 2 (120) through the front upright frame (A8) and fix cable 2 (120) with the respective bolt set. Place two plastic bushings (90) into the front upright frame (A8) and mount pulley P18 (91) into the front upright frame (A8) and mount pulley P18 (91) with one bolt set (98).
8. Tighten all bolts with the tool.

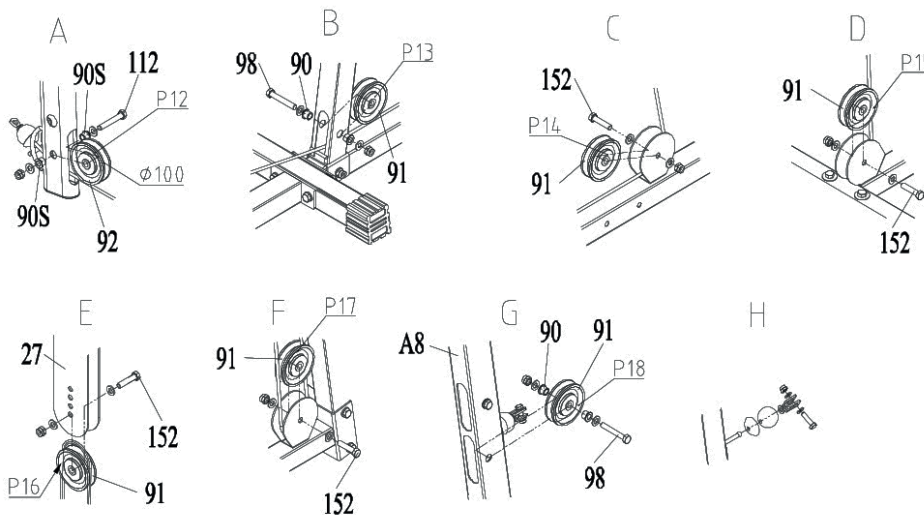

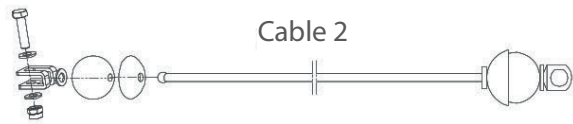
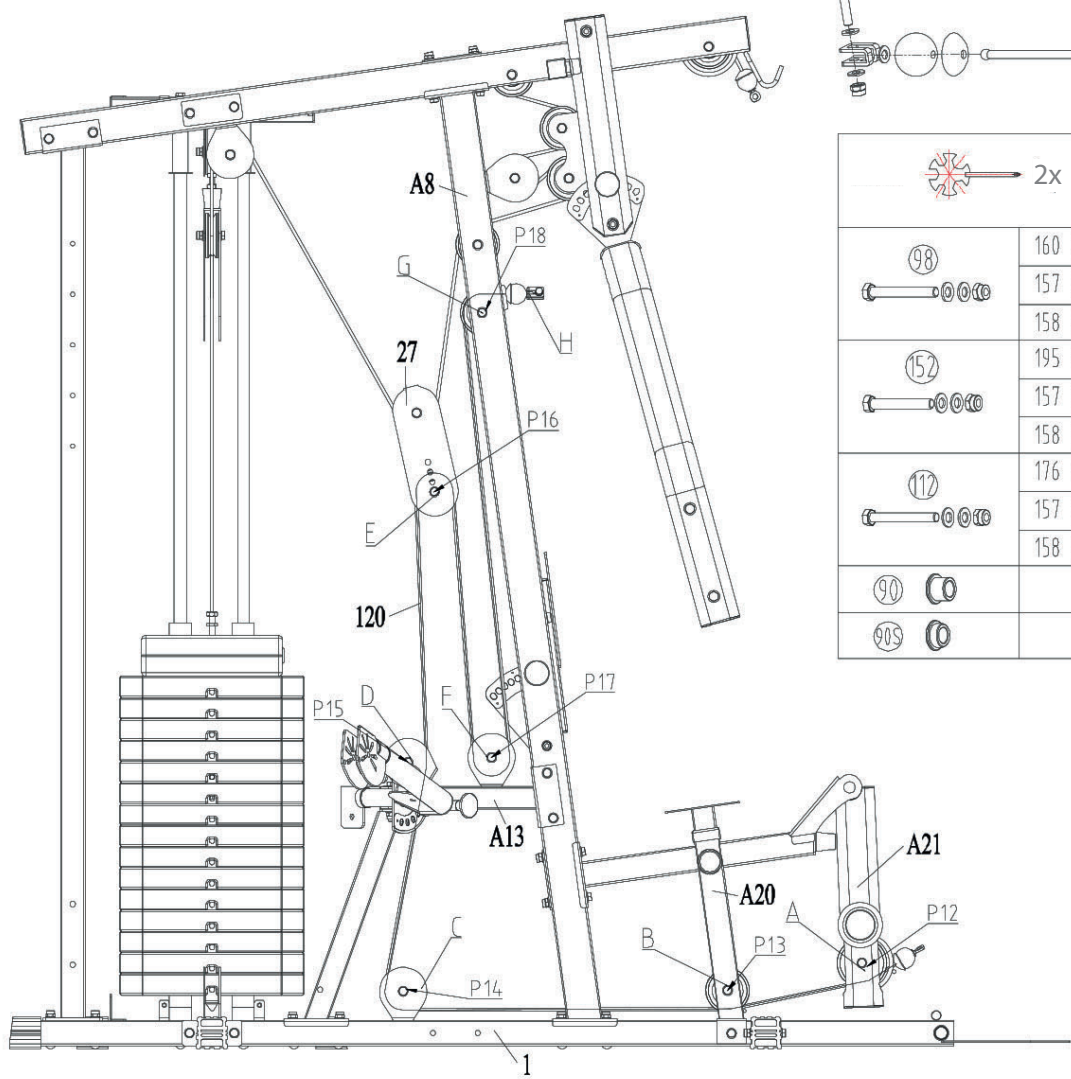

Cable 2

2x			
	160		M10x70 x 2
	157		10 x 4
	158		M10 x 2
	195		M10x45 x 4
	157		10 x 8
	158		M10 x 4
	176		M10x55 x 1
	157		10 x 2
	158		M10 x 1
	x 4		
	x 2		

	x 6
	x 1
	x 1





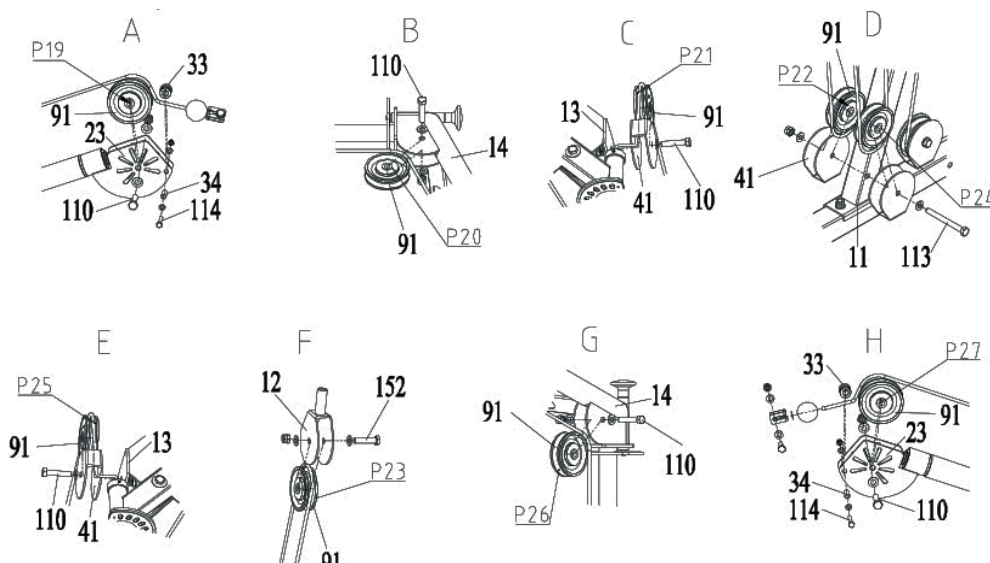



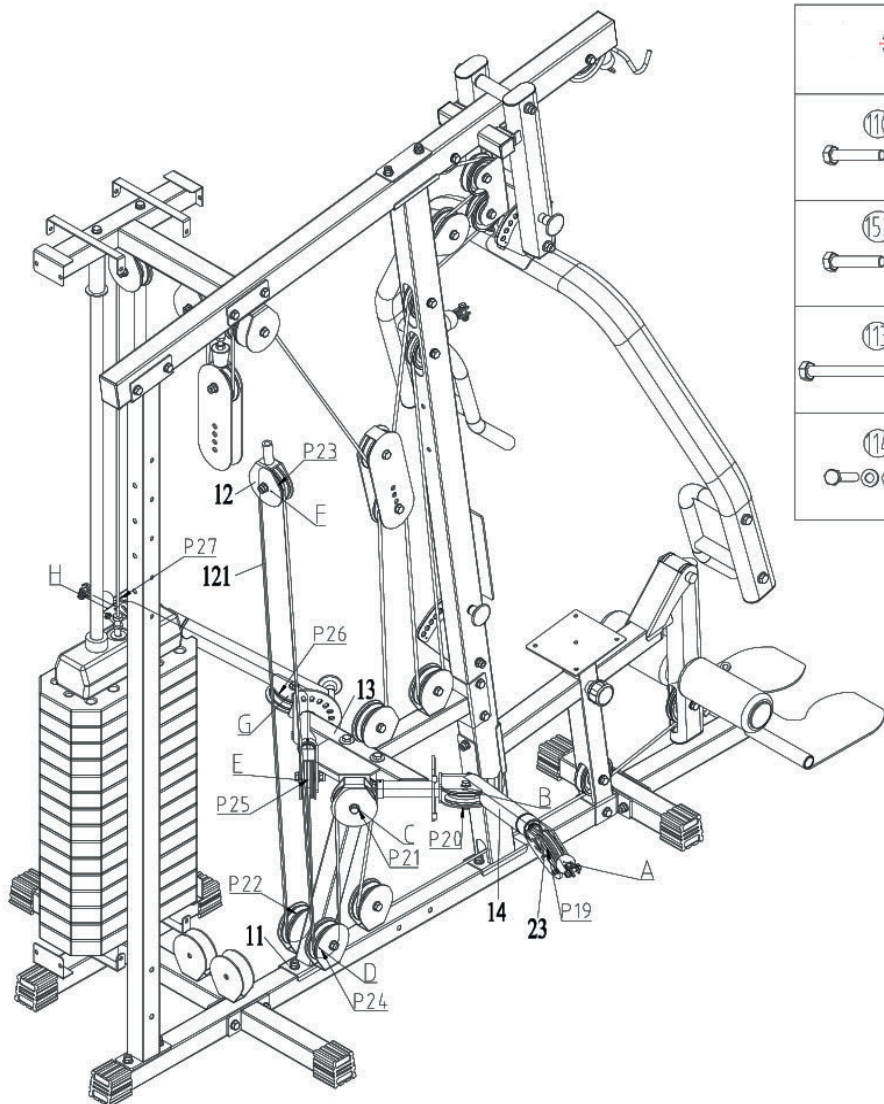
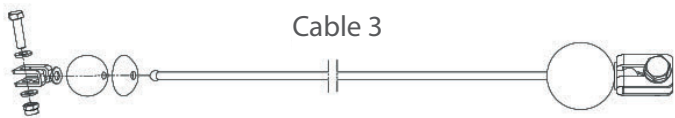







Step 10







1. Figure A: Fix cable 3 (121) to the rotational pulley block (23) with one gyro wheel (33), one bushing (34) and one bolt set (114). Guide cable 3 (121) over pulley P19 (91) and mount pulley P19 (91) to the rotational pulley block (23) with one bolt set (110).
2. Figure B: Fix the cable 3 (121) with pulley P20 (91) to the cable arm (14) with one bolt set (110).
3. Figure C: Guide cable 2 (121) over pulley P21 (91) through the pulley block (41) and mount it to the cable arm assemble (13) with one bolt set (110).
4. Figure D: Mount two pulley blocks (41) and the pulleys P22 and P24 (91) to the rear connector (11) with one bolt set (113). Guide cable 3 (121) underneath pulley P24 (91) trough the pulley block (41).
5. Figure F: Guide cable 3 (121) over pulley P23 (91) and mount pulley P23 (91) to the pulley block (12) with one bolt set (152).
6. Figure D: Guide cable 3 (121) from the back underneath pulley P22 (91) through the pulley block (41).
7. Figure E: Guide cable 3 (121) over pulley P25 (91) through the pulley block (41) and mount it to the cable arm assemble (13) with one bolt set (110).
8. Figure G: Fix cable 3 (121) with pulley P20 (91) to the cable arm (14) with one bolt set (110).
9. Figure H: Guide cable 3 (121) over pulley P27 (91) and mount pulley P27 (91) to the rotational pulley block (23) with one bolt set (110). Fix cable 3 (121) to the rotational pulley block (23) with one gyro wheel (33), one bushing (34), one bolt set (114) and the respective bolt set from cable 3 (121).
10. Tighten all bolts with the tool.



Cable 3



 → 2x			
	174		M10x50 × 6
	157		10 × 12
	158		M10 × 6
	195		M10x45 × 1
	157		10 × 2
	158		M10 × 1
	177		M10x125 × 1
	157		10 × 2
	158		M10 × 1
	178		M6x45 × 2
	179		6 × 4
	180		M6 × 2

12		x 1
33		x 2
34		x 2
41		x 4
91		x 9
121	 L=030	x 1



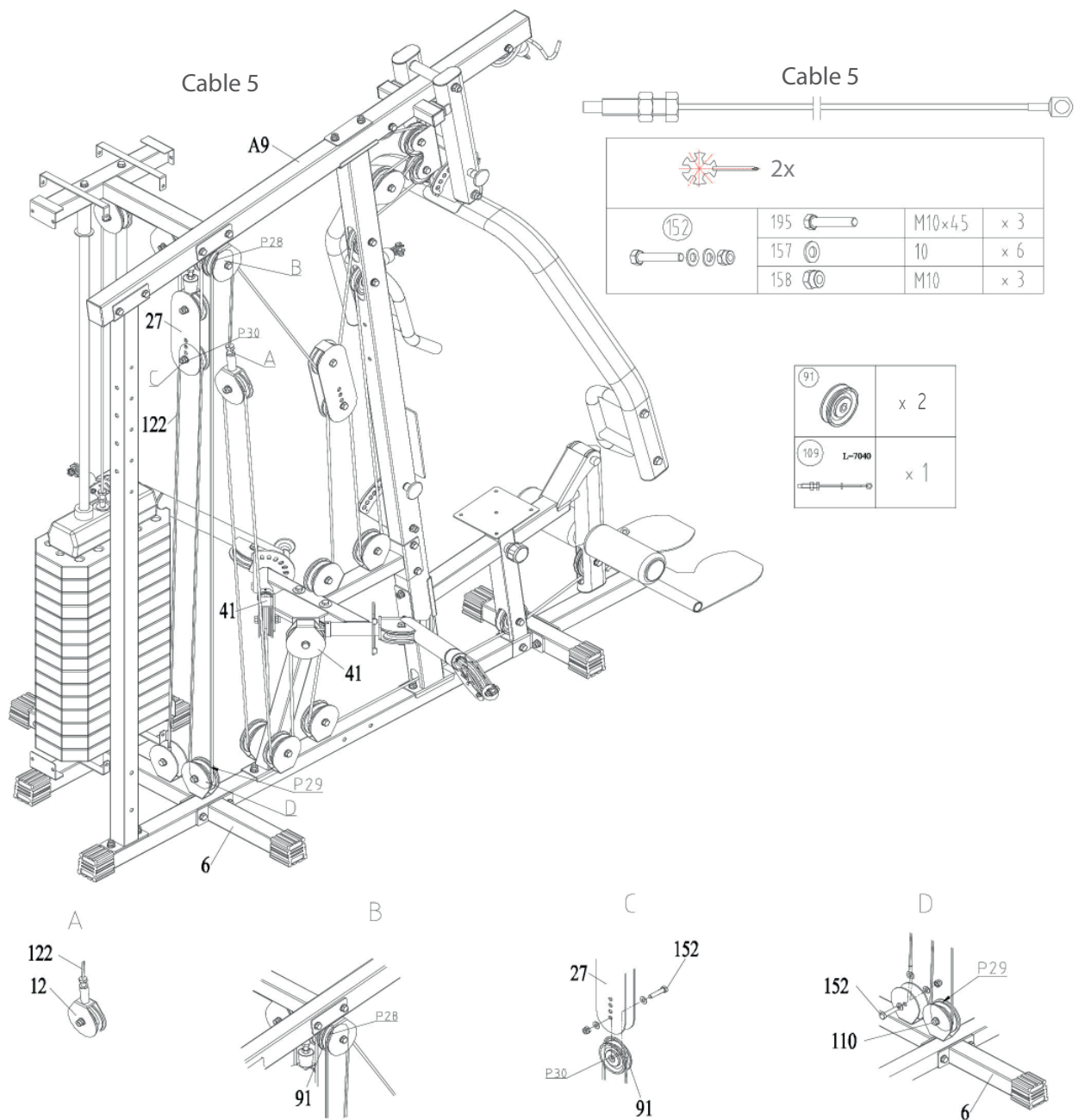

Step 11



1. Figure A: Screw cable 5 (109) into the upper part of the pulley block (12).
2. Figure B: Guide cable 5 (109) over pulley P28 (91) backwards.
3. Figure D: Guide the cable 5 (109) downwards and underneath pulley P29 (91). Mount pulley P29 (91) to the pulley holder on the bottom cross connector (6) with one bolt set (110).
4. Figure C: Guide cable 5 (109) upwards through the adjustable pulley block (27) over pulley P30 (91). Mount pulley P30 (91) to the adjustable pulley block (27) with one bolt set (152).
5. Figure D: Fix cable 5 (109) to the pulley holder on the bottom cross connector (6) with one bolt set (152).
6. Tighten all bolts with the tool.



Step 12

1. Mount the left iron shell (25) to the bottom cross connector (6) and the fixing bracket (10) with four bolt sets (115).
2. Mount the right iron shell (26) to the bottom cross connector (6) and the fixing bracket (10) with four bolt sets (115).
3. Tighten all bolts with the tool.

				
	181		M8x16	x 16
	182		8	x 16



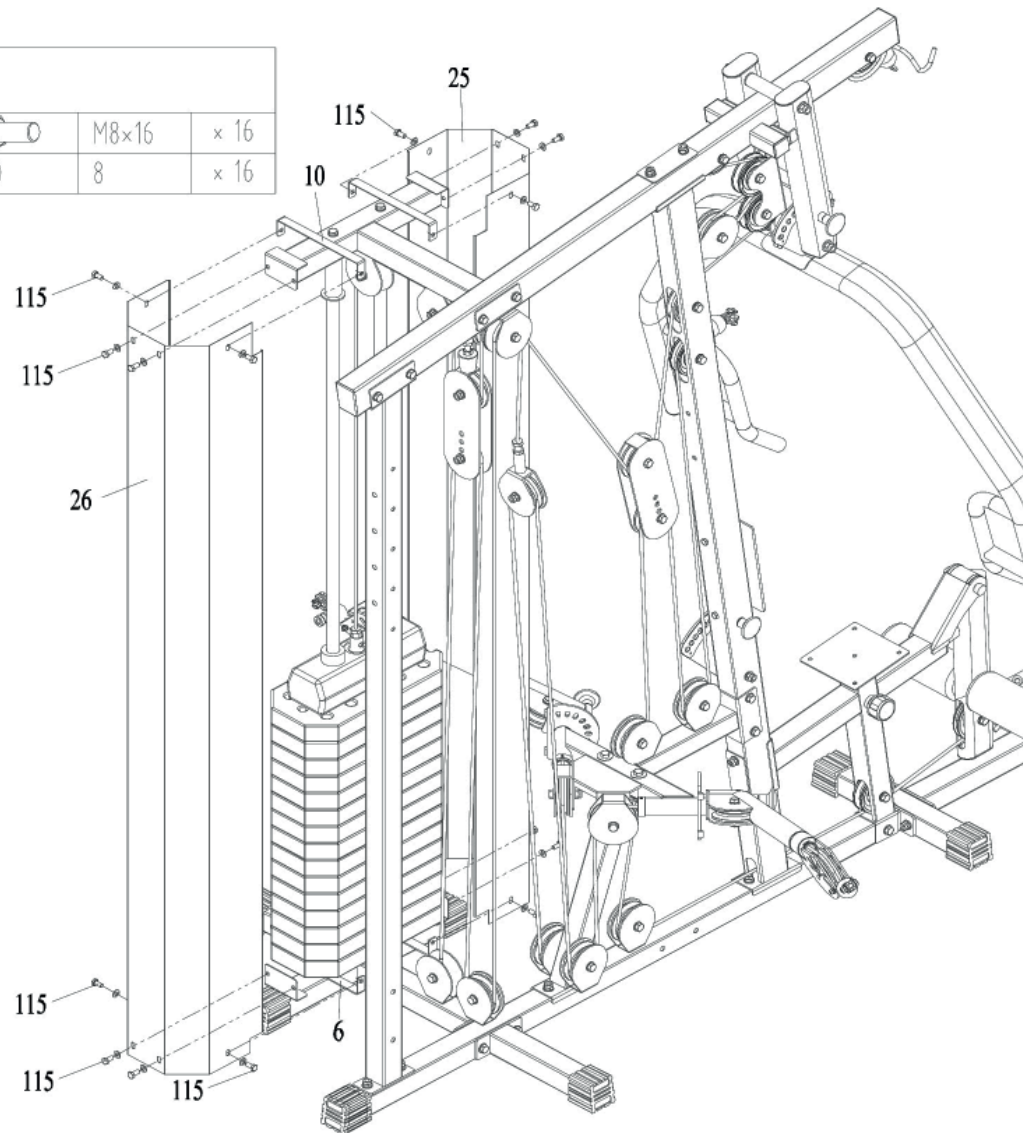

	x 1
	x 1



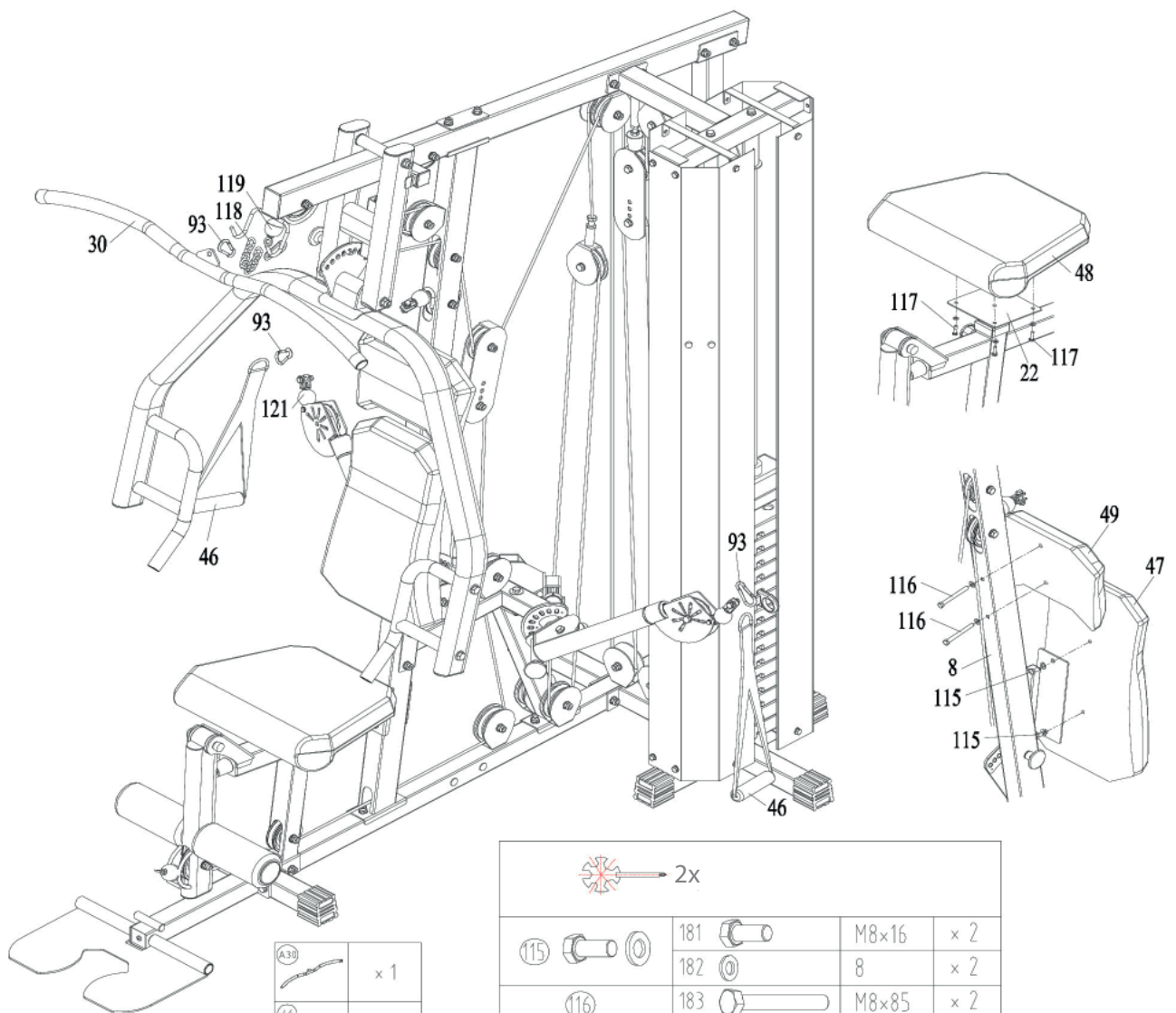















Step 13

1. Mount the seat cushion (48) to the cushion support (22) with four bolt sets (117).
2. Mount the headrest cushion (49) to the front upright frame (8) with two bolt sets (116).
3. Mount the back cushion (47) to the front upright frame (8) with two bolt sets (115).
4. Attach one hand grip (46) to each side on the end of cable 3 (121) with each one hoist hook (93).
5. Attach the lat bar (30) to cable 1 (119) with two hoist hooks (93) and one chain (118).
6. Tighten all bolts with the tool.



	x 1
	x 2
	x 1
	x 1
	x 1

		2x	
	181		M8x16 x 2
	182		8 x 2
	183		M8x85 x 2
	182		8 x 2
	184		M6x20 x 4
	179		6 x 4
			x 4
			x 1

Step 14

Place the plugs (94) into the holes of the base frame (1), rear upright frame (5) and the bottom cross connector (6).

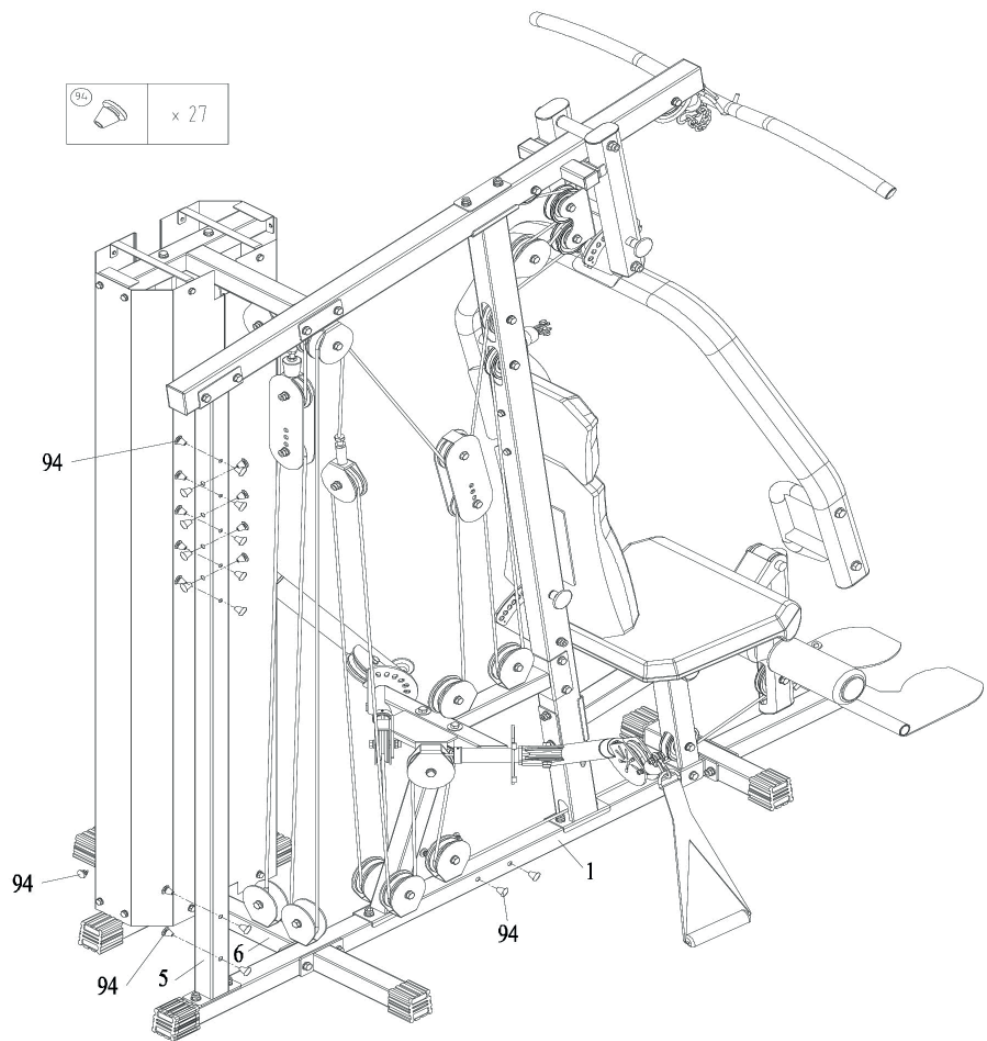

Step 15

Part A of the assembly is completed

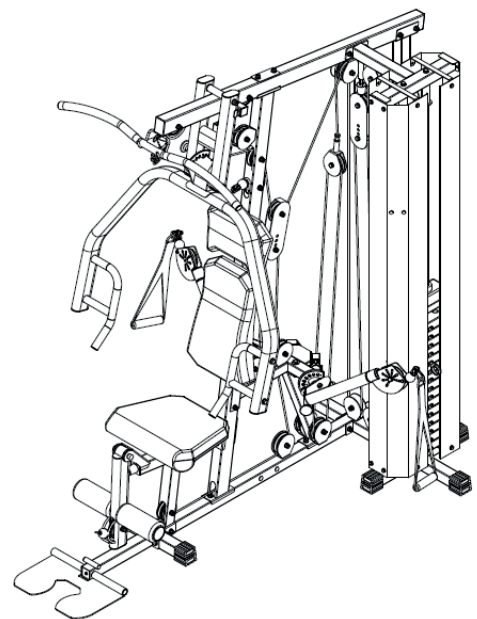

2.3 Assembly Part B











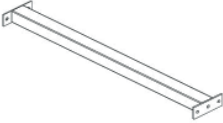
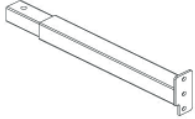
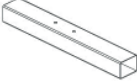

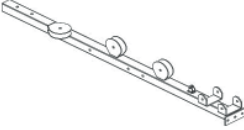

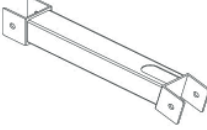
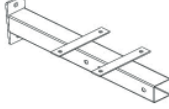
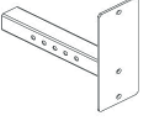
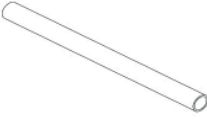

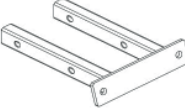

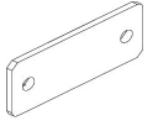



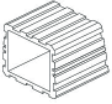



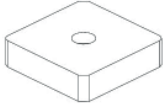

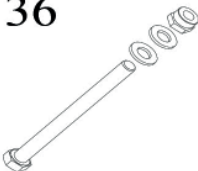





2.3.1 Scope of Delivery

The scope of delivery consist of the following parts. At the beginning, check whether all parts and tools belonging to the device are included in the scope of delivery and whether damage has occurred. In the event of complaints, the contractual partner must be contacted directly.

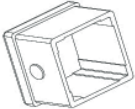

CAUTION

If parts of the scope of delivery are missing or damaged, the assembly must not be carried out.

52 	53 	2 	54 	55 
56 	57 	58 	59 	60 
61 	62 	63 	64 	65 
42 	66 	67 	47 	79 
91 	95 	96 	133 	134 
135 	136 	137 	117 	86 
115 	110 	138 	101 	139 
140 	141 	124 	142 	143 
128 	109 	152 	153 	

2.3.2 Assembly

Before assembly, take a close look at the individual assembly steps shown and carry out the assembly in the order given.









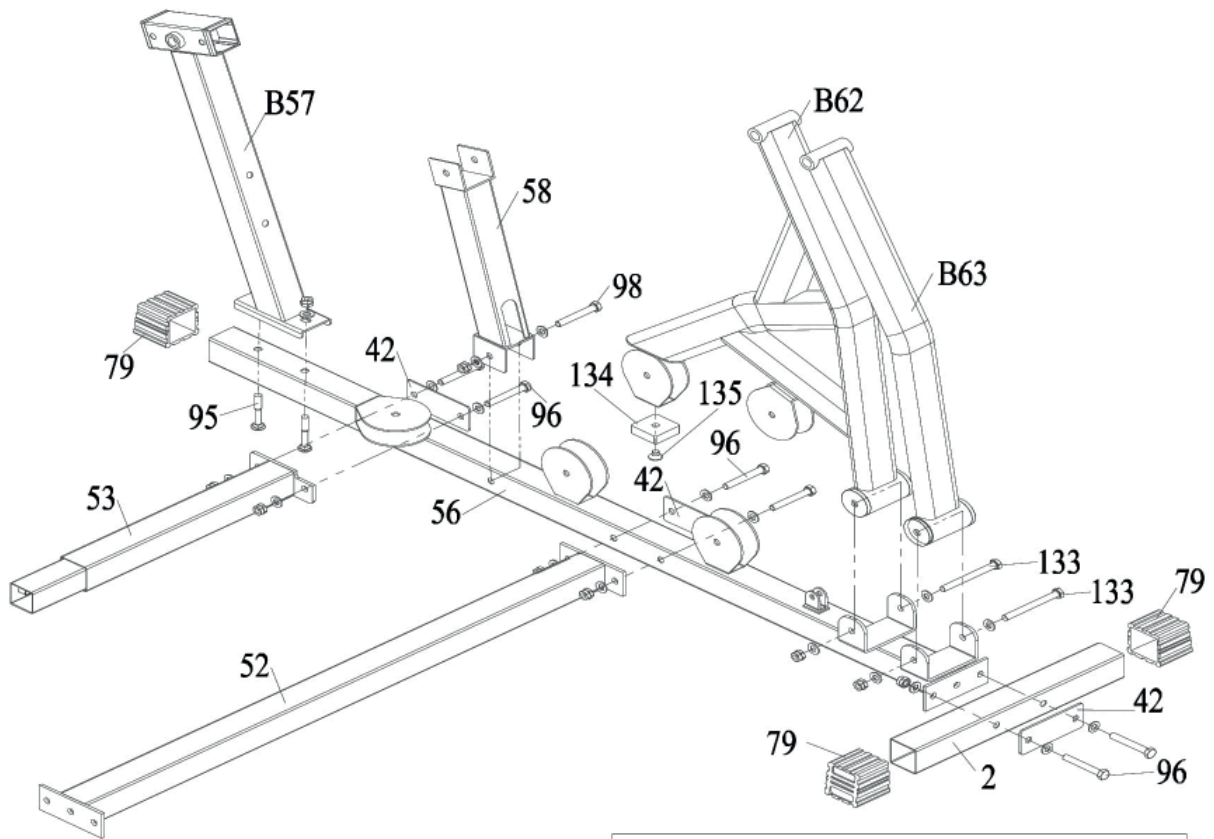

NOTICE





























- + First loosely screw all parts together and check that they fit properly. Tighten the screws using the tool only when you are instructed to do so.
- + If you have difficulty recognising the graphics, we recommend that you open and/or download the PDF instructions stored in the webshop on your end device (e.g. smartphone, tablet or PC). There you have the option of zooming in closer. Please note that the Adobe Acrobat Reader programme must be installed on your end device in order to open the file.

Step 16

1. Place the end caps (79) onto the front base tube (2) and the leg extension base frame (56).
2. Mount the connecting tube A (52) and the joint plate (42) to the leg extension base frame (56) with two bolt sets (96).
3. Mount the connecting tube B (53) and the joint plate (42) to the leg extension base frame (56) with two bolt sets (96).
4. Mount the support (B57) to the leg extension base frame (56) with two bolt sets (95).
5. Mount the upright support (58) to the leg extension base frame (56) with one bolt set (98).
6. Mount the front base tube (2) and the joint plate (42) to the leg extension base frame (56) with two bolt sets (98).
7. Mount the square block (134) to the foot extension pole (B62) with one screw (135).
8. Mount the foot extension pole (B62) to the leg extension base frame (56) with one bolt set (133).
9. Mount the foot extension pole (B63) to the leg extension base frame (56) with one bolt set (133).
10. Tighten all bolts with the tool.



	x 1		x 1
	x 3		x 1
	x 1		x 1
	x 1		x 1
	x 1		x 3
	x 1		

		 2x		
	156		M10x60	x 2
	157		10	x 2
	158		M10	x 2
	159		M10x75	x 6
	157		10	x 12
	158		M10	x 6
	160		M10x70	x 1
	157		10	x 2
	158		M10	x 1
	185		M10x115	x 2
	157		10	x 4
	158		M10	x 2
	186		M10x20	x 1

Step 17

1. Mount the seat support (59) to the upright support (58) with one bolt set (98).
2. Mount the seat support (59) and the joint plate (42) to the support (B57) with two bolt sets (96).
3. Mount the right armrest (B54) and the left armrest (B55) to the seat support (59) with two bolt sets (96).
4. Mount the seat cushion (67) to the seat support (59) with four bolt sets (117).
5. Mount the foot extension support (B64) to the foot extension pole (B62) and the foot extension pole (B63) with two rotate bushings (61) and two bolt sets (136).
6. Mount the foot plate (B65) to the foot extension support (B64) with two bolt sets (137).
7. Tighten all bolts with the tool.

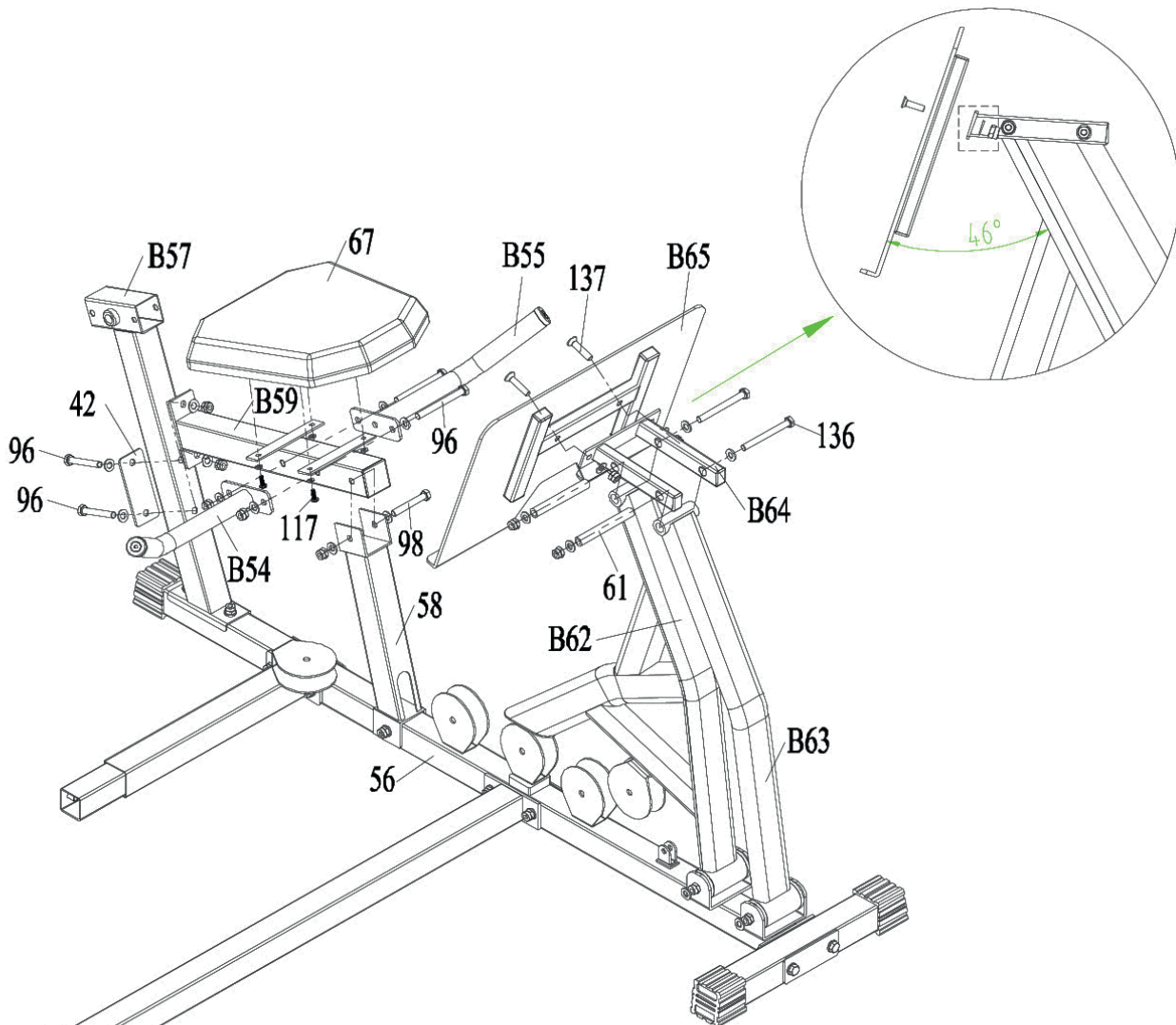

tools		2x L plus		washer 6	
	159		M10x75	x 4	
	157		10	x 8	
	158		M10	x 4	
	160		M10x70	x 1	
	157		10	x 2	
	158		M10	x 1	
	184		M6x20	x 4	
	179		6	x 4	
	187		M10x135	x 2	
	157		10	x 4	
	158		M10	x 2	
	188		M10x40	x 2	
	157		10	x 2	
	158		M10	x 2	

	42	x 1
	B55	x 1
	B54	x 1
	B59	x 1
	61	x 2
	B64	x 1
	B65	x 1
	67	x 1

Step 18



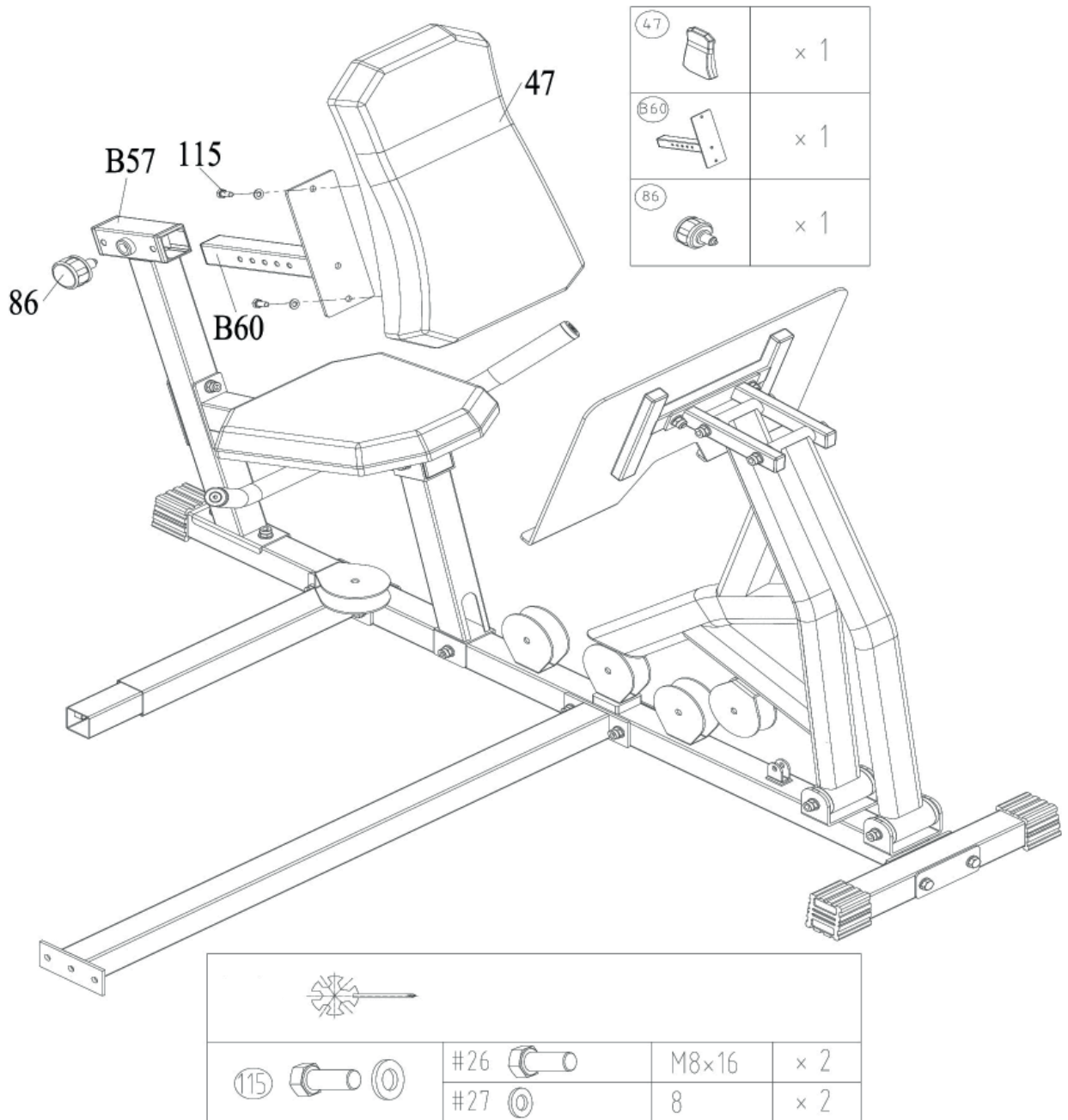



1. Fix the back support (B60) on the support (B57) with the fast pin (86).
2. Mount the back cushion (47) to the back support (B60) with two bolt sets (115).
3. Tighten all bolts with the tool.

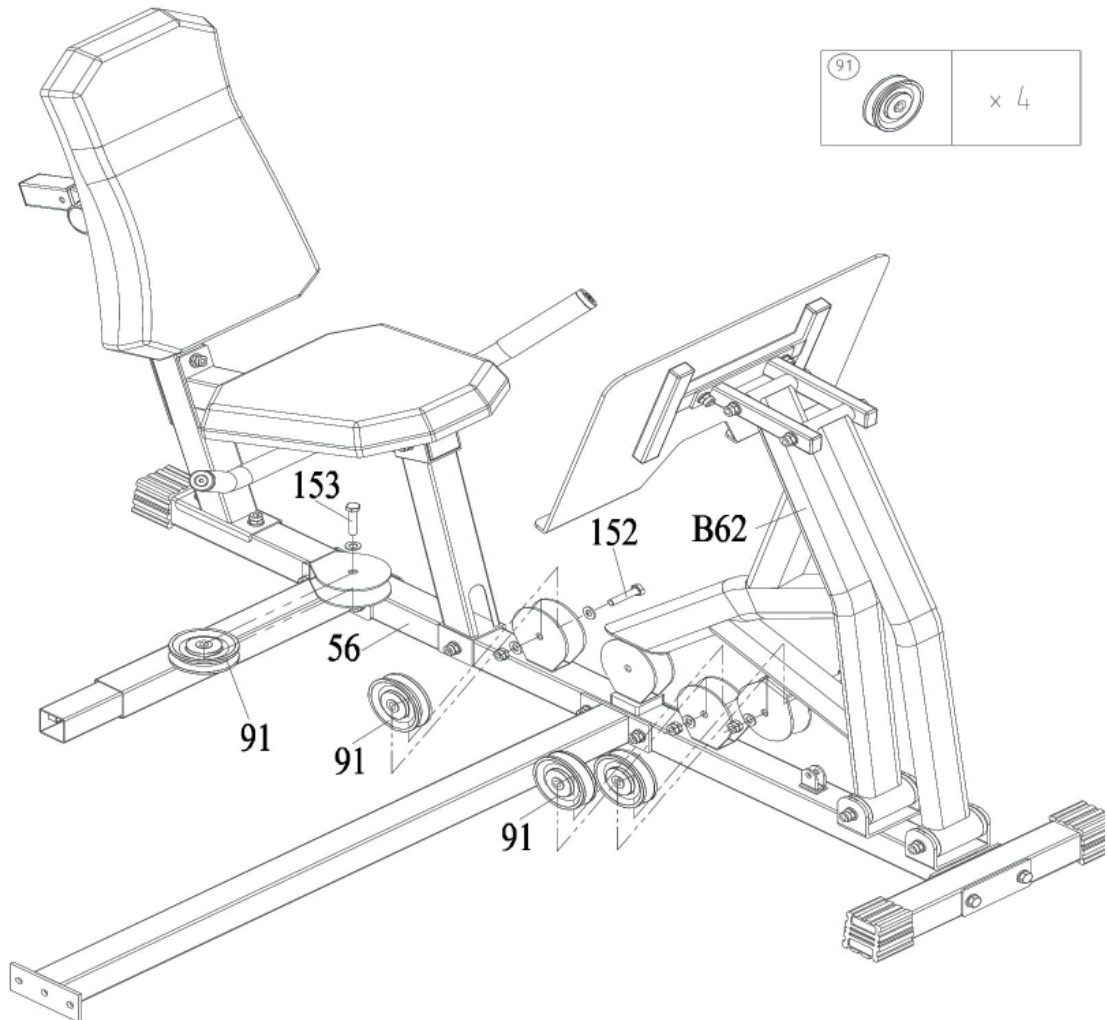

Step 19



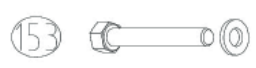







1. Mount pulley P32 (91) to the foot extension pole (B62) with one bolt set (153).
2. Mount pulley P33 (91), P35 (91) and P36 (91) to the leg extension base frame (56) with three bolt sets (152).
3. Tighten all bolts with the tool.





 → 2x				
	195		M10×45	× 3
	157		10	× 6
	158		M10	× 3
	195		M10×45	× 1
	157		10	× 1

Step 20

1. Mount the connecting tube A (52) and the joint plate (42) to the base frame (1) with two bolt sets (96).
2. Mount the connecting tube B (53) to the bottom cross connector (6) with one bolt set (101).
3. Tighten all bolts with the tool.

	→	2x		
	159		M10x75	x 2
	157		10	x 4
	158		M10	x 2
	101		M10x20	x 1
	157		10	x 1

	x 1
	x 1

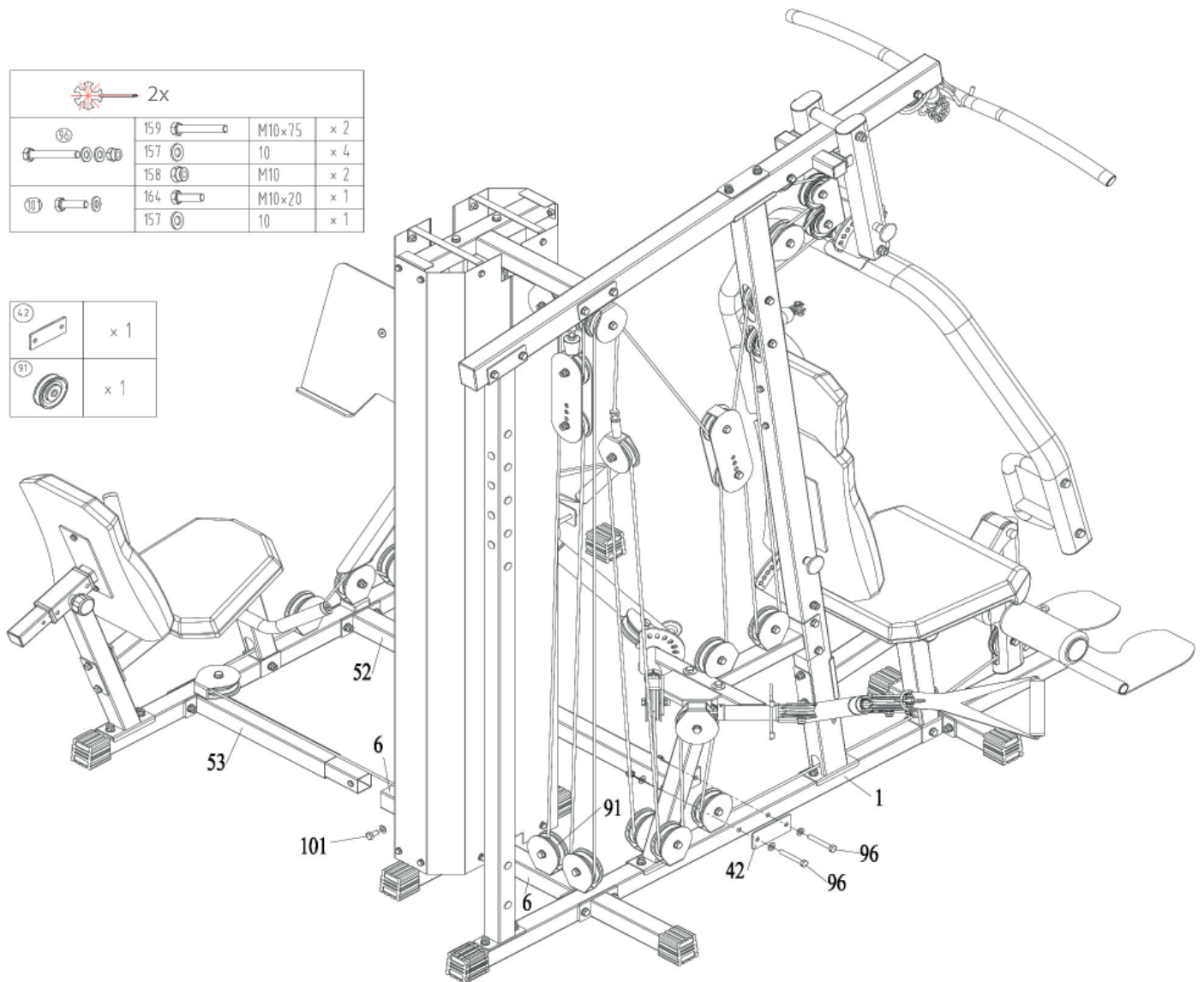

Step 21

1. Remove the bolt set (152) and the end of cable 5 (109) from the pulley holder on the bottom cross connector (6).
2. Mount pulley P31 (91) to the pulley holder with the previously removed bolt set (152) and guide cable 5 (109) along underneath pulley P31 (91) and the weight plates (50) in the direction to pulley P32.
3. Tighten all bolts with the tool.

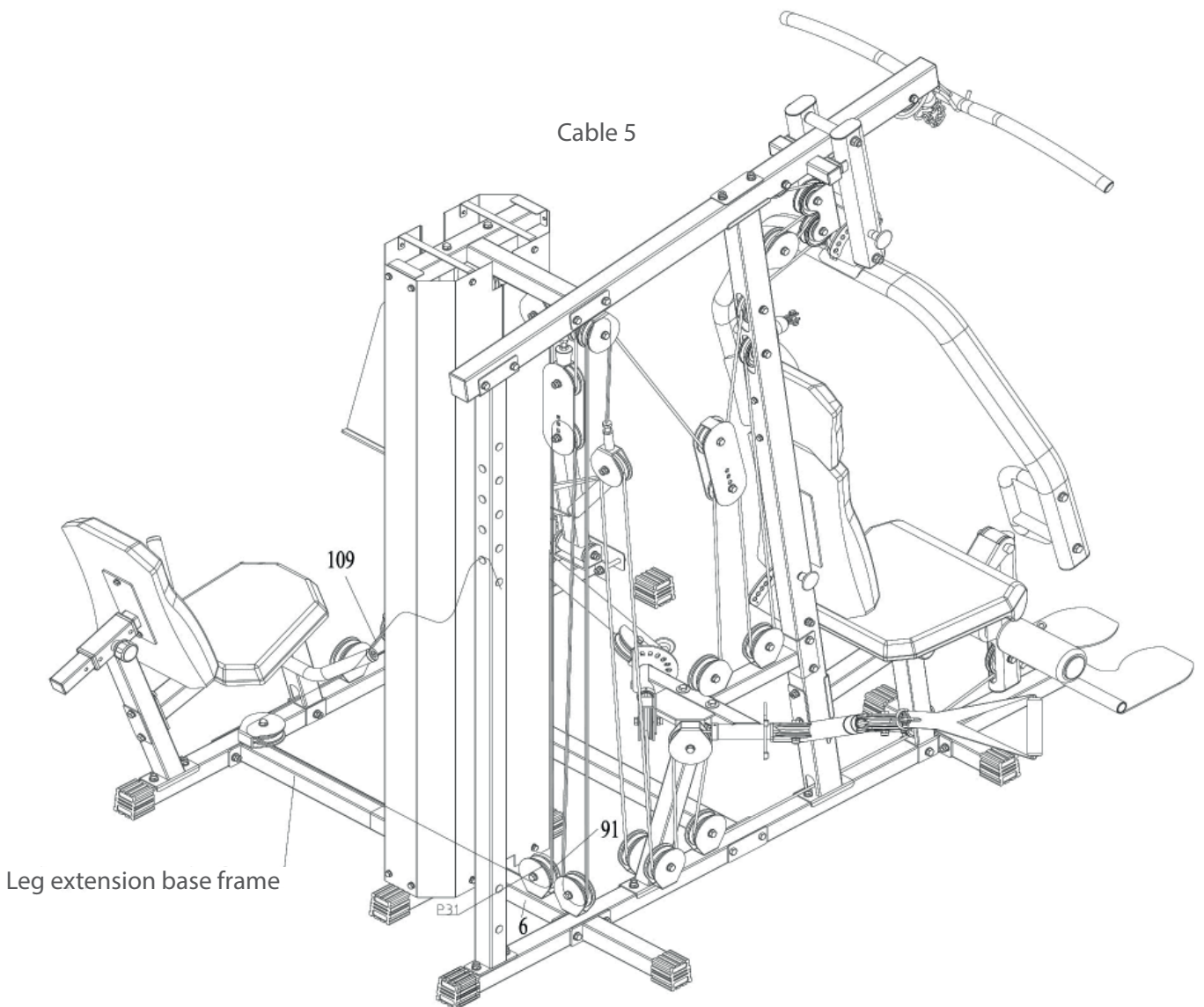

Step 22 and Step 23

1. Guide cable 5 (109) along pulley P32 (91) through the upright support (58) and along underneath pulley P33 (91).
2. Place cable 5 (109) on pulley P34 (91) and mount pulley P34 (91) to the foot extension pole (B62) with one bolt set (110).
3. Guide cable 5 (109) along underneath pulley P35 (91) and over pulley P36 (91).
4. Fix the end of cable 5 (91) to the leg extension base frame (56) with one bolt set (138).
5. Tighten all bolts with the tool.

Part B of the assembly is completed

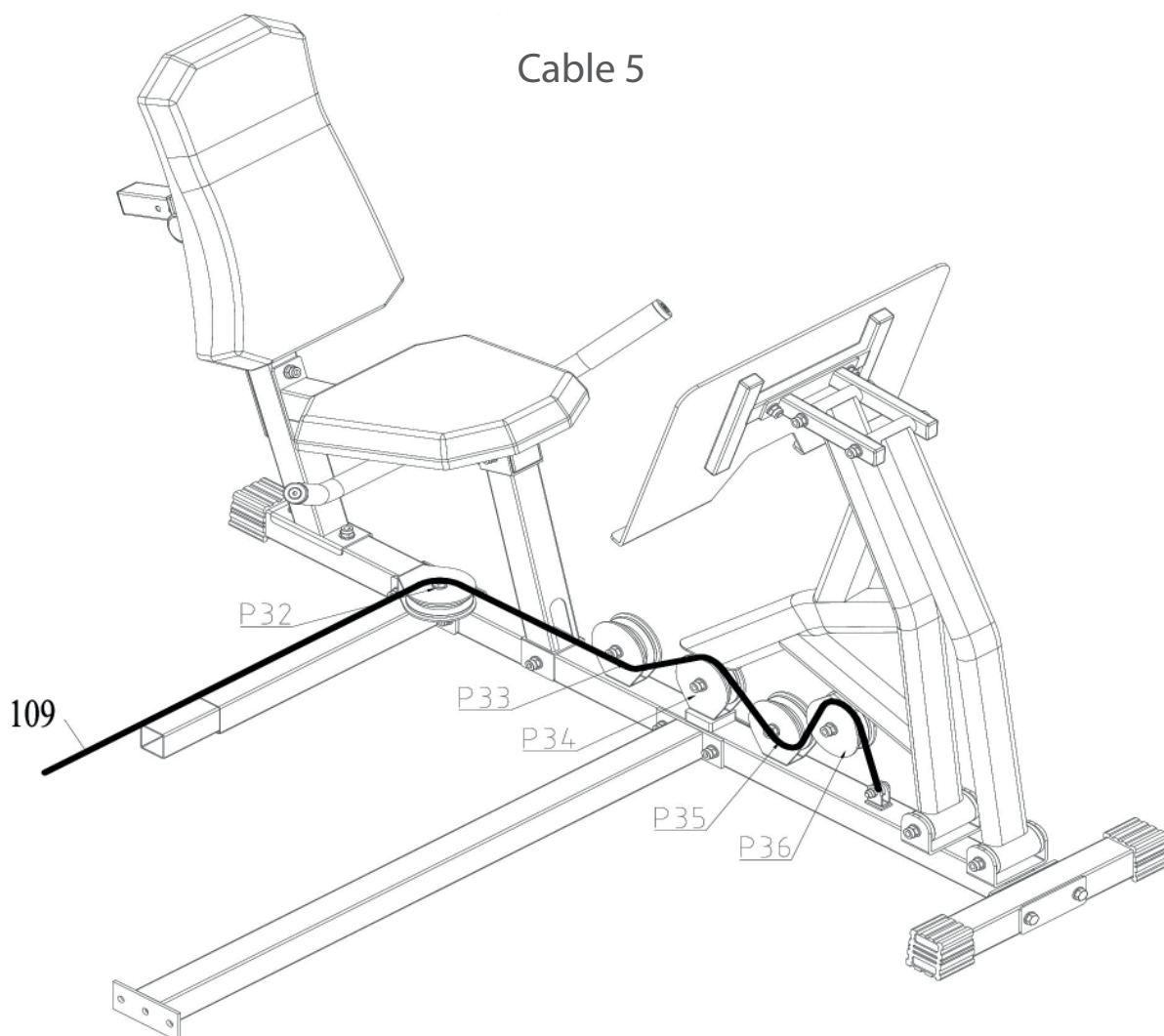

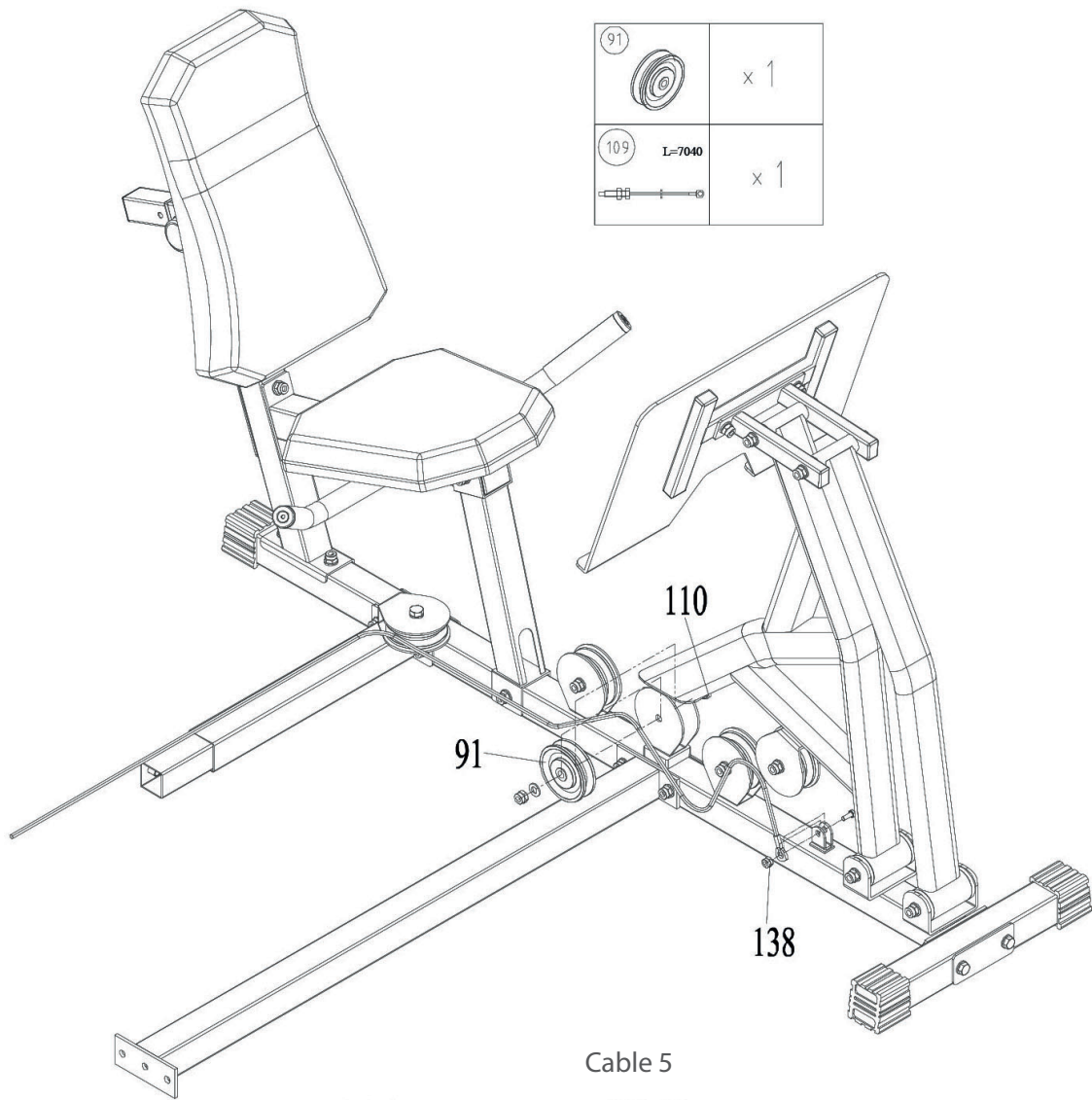

91		x 1
109	L=7040 	x 1



2x			
	174		M10x50 x 1
	157		10 x 2
	158		M10 x 1
	189		M8x30 x 1
	196		M8 x 1

2.4 Assembly Part C







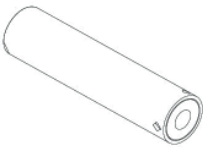
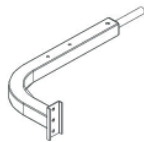
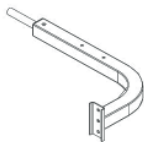
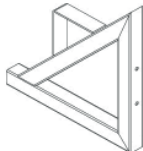

2.4.1 Scope of Delivery

The scope of delivery consist of the following parts. At the beginning, check whether all parts and tools belonging to the device are included in the scope of delivery and whether damage has occurred. In the event of complaints, the contractual partner must be contacted directly.

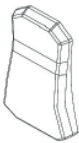

CAUTION

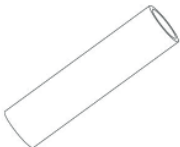
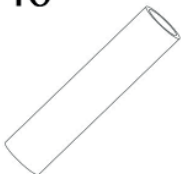
If parts of the scope of delivery are missing or damaged, the assembly must not be carried out.

68 	69 	70 	71 	66 
72 	47 	96 	139 	144 
145 	140 	146 	147 	79 

2.4.2 Assembly

Before assembly, take a close look at the individual assembly steps shown and carry out the assembly in the order given.



NOTICE

- + First loosely screw all parts together and check that they fit properly. Tighten the screws using the tool only when you are instructed to do so.
- + If you have difficulty recognising the graphics, we recommend that you open and/or download the PDF instructions stored in the webshop on your end device (e.g. smartphone, tablet or PC). There you have the option of zooming in closer. Please note that the Adobe Acrobat Reader programme must be installed on your end device in order to open the file.

Step 24

1. Place the end caps (79) onto the end of the foot exercise (71) and mount the foot exercise (71) to the rear support frame (5) with two bolt sets (144).
2. Mount the left support pole (C69) and the right support pole (C70) to the rear support frame (5) with two bolt sets (98).
3. Mount the armrest cushions(72) to the left support pole (C69) and the right support pole (C70) with each two bolt sets (145)
4. Mount the back cushion (47) to the rear upright frame (5) with two bolt sets (145).
5. Mount the upright handles (C68) to the left support pole (C69) and the right support pole (C70) with each one bolt set (147).
6. Tighten all bolts with the tool.

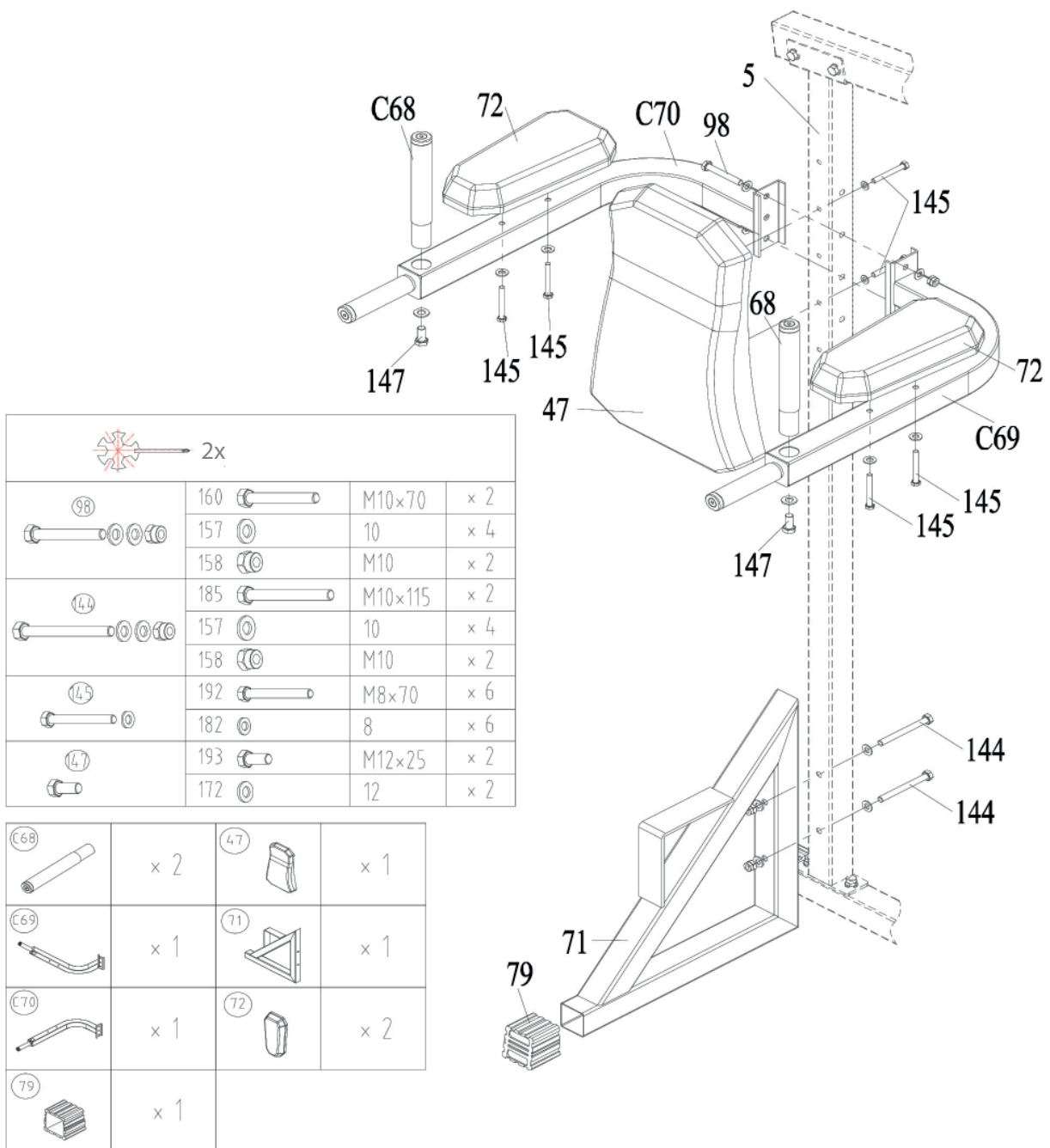

Step 25

Part C of the assembly is completed

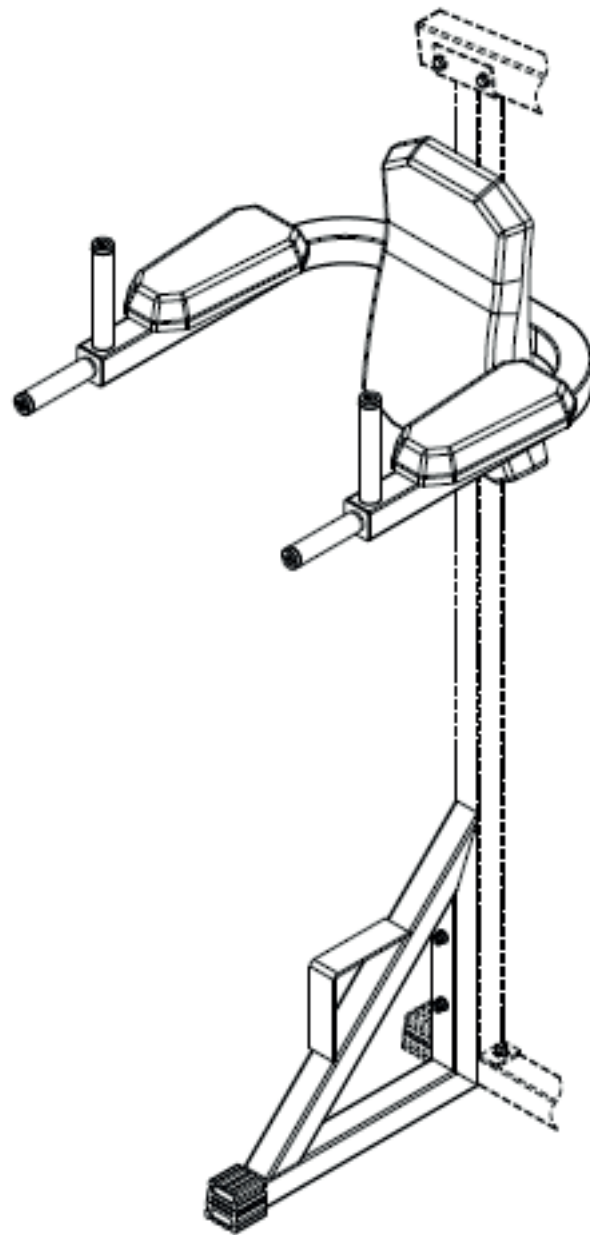

2.5 Assembly Part D









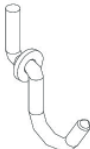

2.5.1 Scope of Delivery

The scope of delivery consist of the following parts. At the beginning, check whether all parts and tools belonging to the device are included in the scope of delivery and whether damage has occurred. In the event of complaints, the contractual partner must be contacted directly.

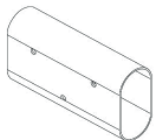
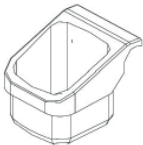

CAUTION

If parts of the scope of delivery are missing or damaged, the assembly must not be carried out.

73 	74 	75 	76 	77 
78 	93 	102 	118 	125 
126 	140 			

2.5.2 Assembly

Before assembly, take a close look at the individual assembly steps shown and carry out the assembly in the order given.



NOTICE

- + First loosely screw all parts together and check that they fit properly. Tighten the screws using the tool only when you are instructed to do so.
- + If you have difficulty recognising the graphics, we recommend that you open and/or download the PDF instructions stored in the webshop on your end device (e.g. smartphone, tablet or PC). There you have the option of zooming in closer. Please note that the Adobe Acrobat Reader programme must be installed on your end device in order to open the file.

Step 26 and Step 27

1. Attach the abdominal strap (74) to cable 2 (120) with one hoist hook (93).
2. Attach the low row bar (D73) or the ankle strap (76) to cable 2 (120) with two hoist hooks (93) and one chain (118).
3. Attach the rack (78) to the right iron shell (26)
4. Attach the hooks (75) to the rear upright support (5).

Part D of the assembly is completed

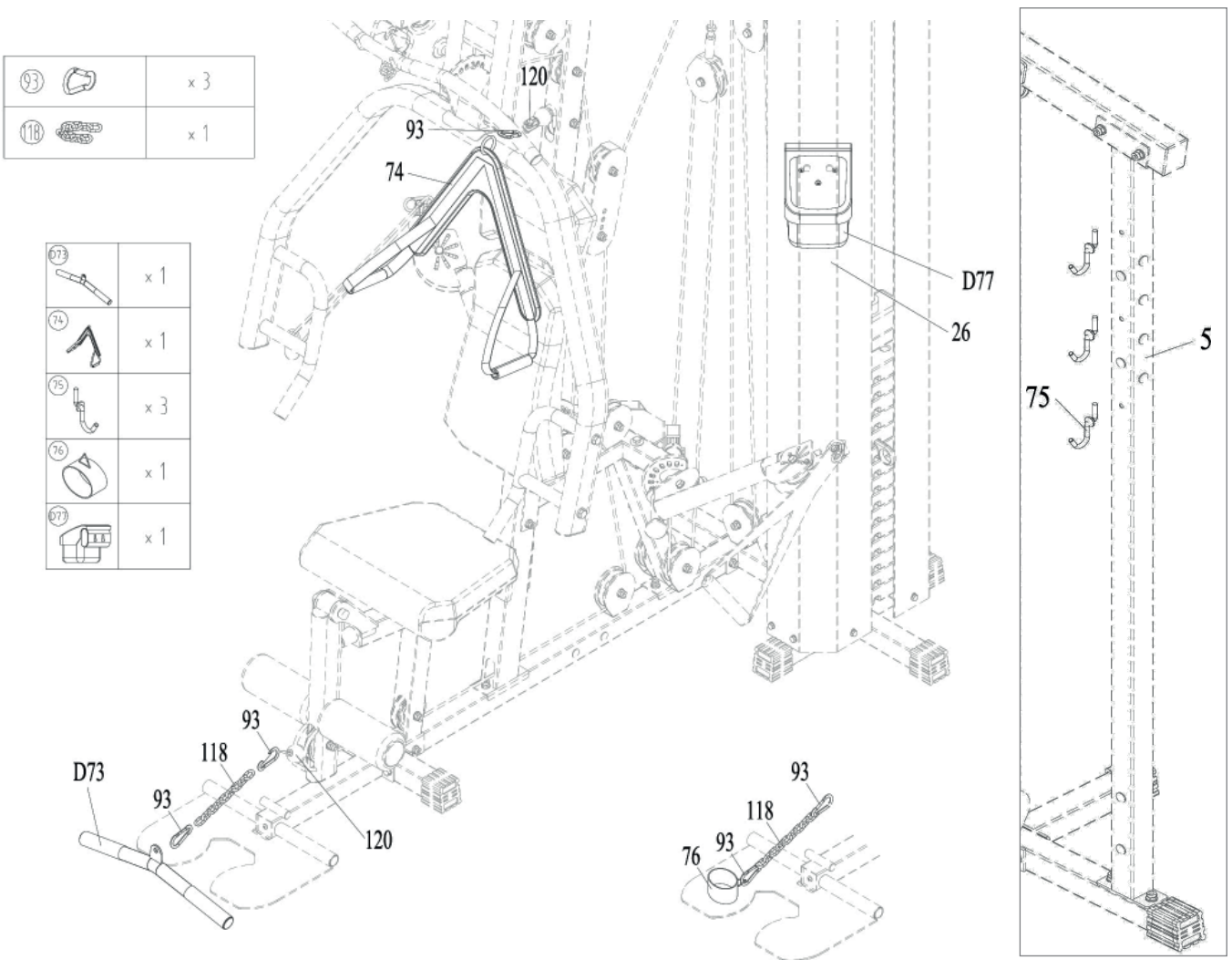

Step 28

To level the floor, additional protect pads (151) can be used.

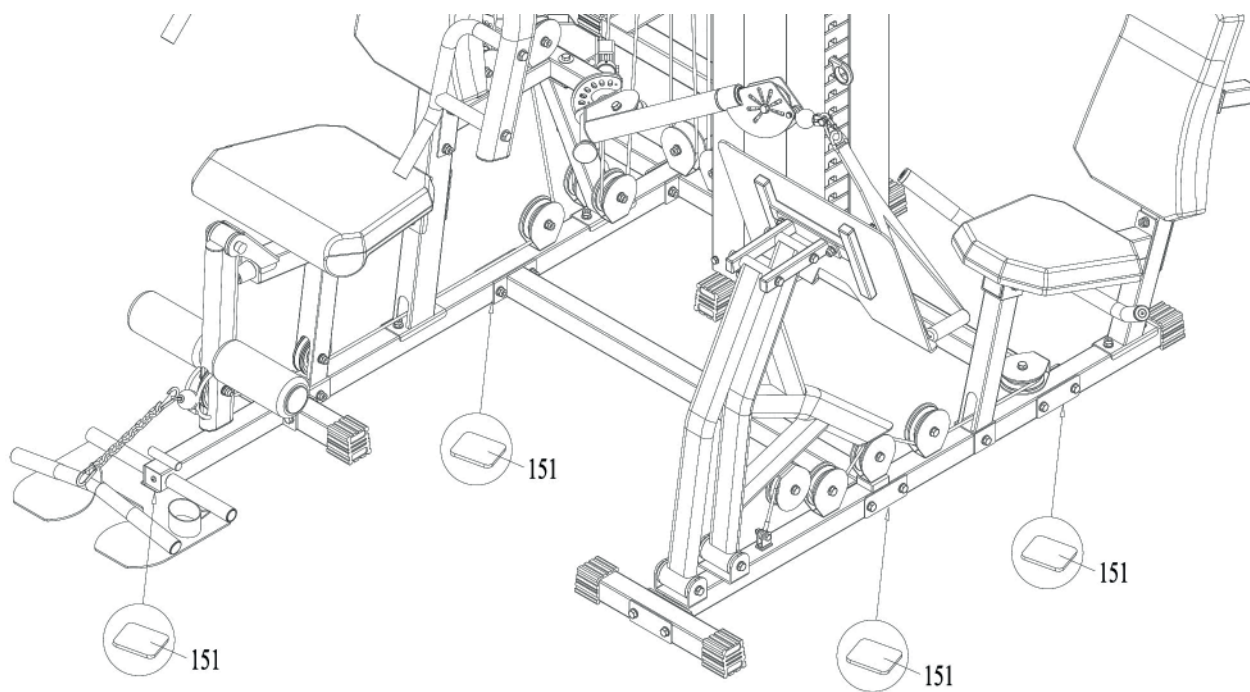

2.6 Cable Installation Overview

2.6.1 Part A

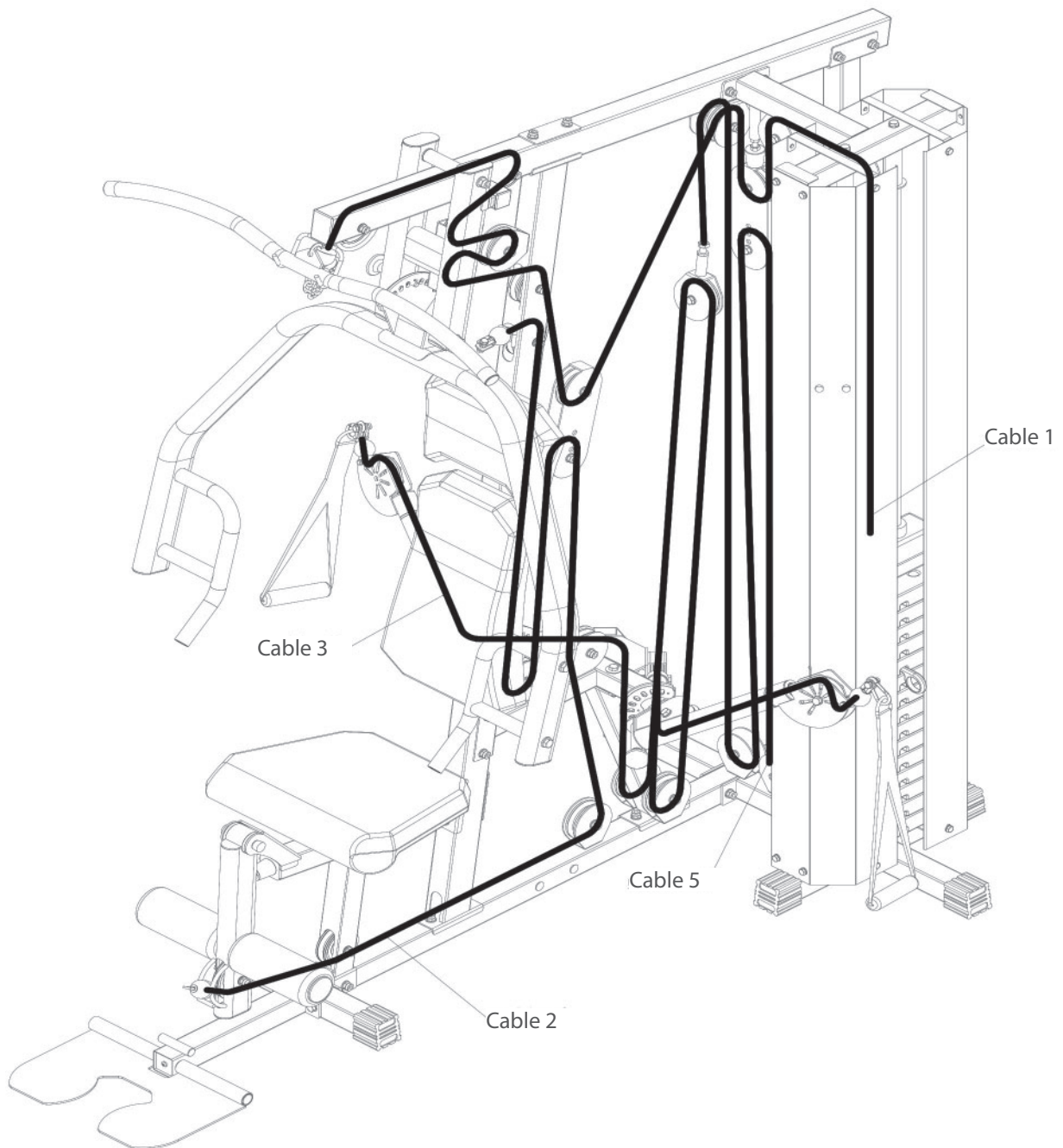

2.6.2 Part B

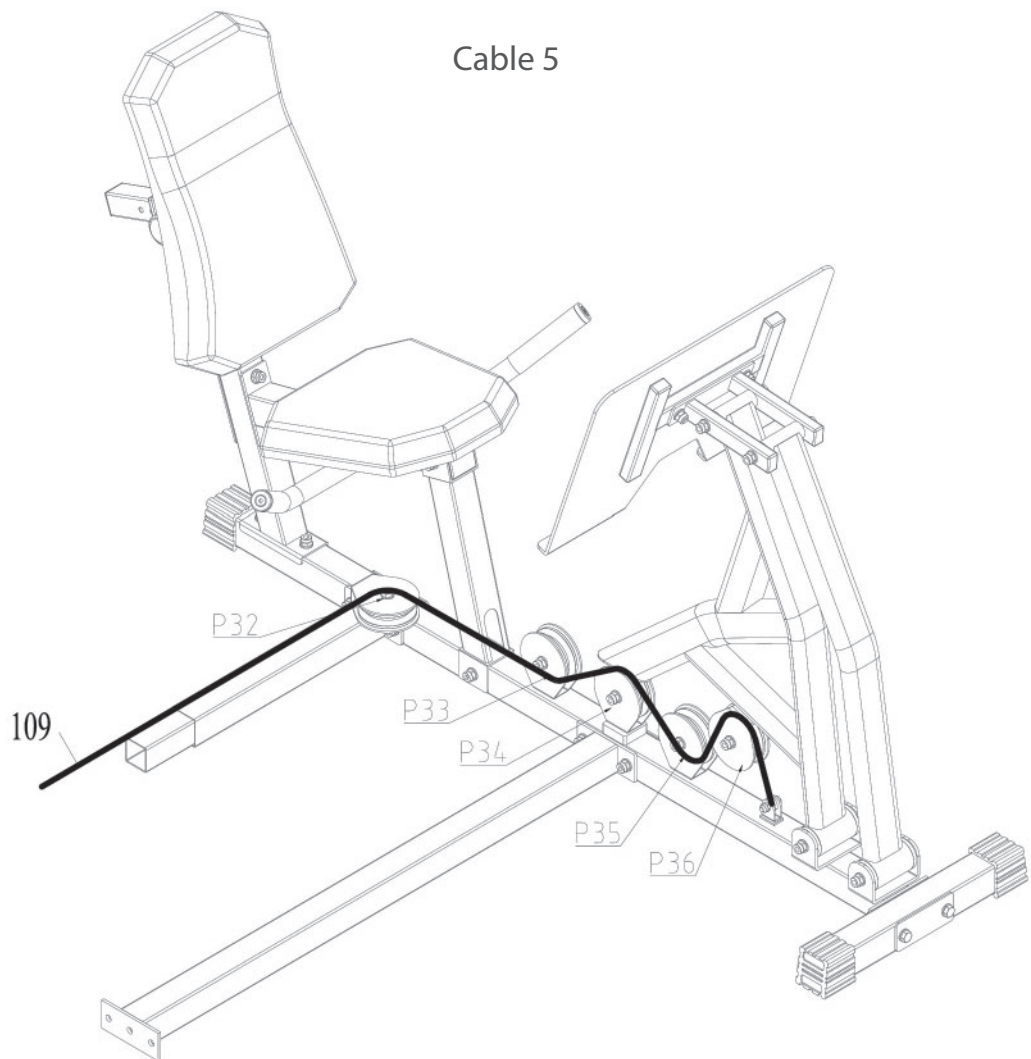

Load and Unload Weight Plates



CAUTION

- + Make sure to always use some sort of weight collar when exercising with external weights.
- + Never store unused weight plates on the floor.
- + Store unused weight plates on a weight rack or respective storage horns.

3 STORAGE AND TRANSPORT

3.1 General Instructions



WARNING

- + The storage location should be chosen so that improper use by third parties or children can be prevented.
- + If your equipment does not have transportation wheels, the equipment must be disassembled before transportation.

▶ ATTENTION

- + Make sure that the equipment is protected from moisture, dust and dirt in the selected storage location. The storage location should be dry and well ventilated and have a constant ambient temperature between 10°C and 35°C.

4.1 General Instructions



WARNING

- + Do not make any improper changes to the equipment.



CAUTION

- + Damaged or worn components may affect your safety and the life of the equipment. Therefore, immediately replace damaged or worn components. In such a case, contact the contract partner. The equipment must not be used until it has been repaired. If necessary, use only original spare parts.

ATTENTION

- + In addition to the instructions and recommendations for maintenance and care given here, additional service and/or repair work may be necessary; this must only be carried out by authorised service technicians.

4.2 Faults and Fault Diagnosis

The equipment undergoes regular quality controls during production. Nevertheless, faults or malfunctions may occur. Frequently, individual parts are responsible for these disturbances, an exchange is usually sufficient. Please refer to the following overview for the most common errors and how to correct them. If the equipment still does not function properly, contact your contract partner.

Fault	Cause	Solution
Grinding noises	Cables or pulleys do not run smoothly or are damaged	+ Visual inspection of the cable routing or the pulley guide + If damaged, replace the defective part
Weight hanging in the air	Cable tensioned too tight	Readjust cable tension
Cable without tension	Cable too loose	+ Check cable routing + Readjust cable tension
Squeaking & cracking noises	Screw connections loosened or too tight	+ Check or lubricate screw connections* + Check cable routing
Unit wobbles	+ Uneven ground + Loose screw connections	+ Align unit + Tighten screw connections
Heavy draught	+ Weight holders/guide rods too dry + Faulty cable routing	+ Lubricate guide rods* + Check cable routing

* With a grease-free silicone oil or silicone spray.

4.3 Maintenance and Inspection Calendar

To avoid damage from body sweat, the equipment must be cleaned with a damp towel (no solvents!) after each training session.

The following routine tasks must be performed at the specified intervals:

Part	Weekly	Monthly	Quarterly	Half-yearly	Yearly
Cables and pulleys	C/I				
Bolt connections		I			
Pulleys and cables	I				
C = clean; I = inspect					

5 DISPOSAL

At the end of its operational life, this equipment cannot be disposed of in normal household waste. Instead, it must be disposed of via an recycling centre. Further information can be obtained from your local authority's recycling service.



The materials can be recycled as per their symbols. Through the reuse, recycling of materials or other forms of recovery of old equipment, you make an important contribution to the protection of the environment.

6 RECOMMENDED ACCESSORIES

To make your training experience even more efficient and pleasant, we recommend that you add suiting accessories to your fitness equipment. For training equipment like smith machines, weight benches or racks this could for example be a **floor mat**, which makes your fitness equipment stand more securely and also protects the floor from sweat but it could be also **additional weights, handles, foot straps** for leg exercises or **triceps ropes**. For some smith machines, there are also optional add-ons such as **leg presses** that make your workout even more intense and comprehensive.

Our range of accessories offers the highest quality and makes training even better. If you would like to find out more about compatible accessories, please go to the detail page of the product in our webshop (the easiest way is to enter the article number in the search field above) and go to the recommended accessories on this page. Of course, you can also contact our customer service: by telephone, e-mail, in one of our branches or via our social media channels. We will be happy to advise you!



floor mat



chest strap



triceps rope



weight block extension

7.1 Serial Number and Model Name

In order to provide you with the best possible service, please have the model name, article number, serial number, exploded drawing and parts list ready. The corresponding contact options can be found in chapter 9 of this operating manual.

NOTICE

The serial number of your equipment is unique. It's located on a white sticker. The exact position of this sticker is shown in the following illustration.

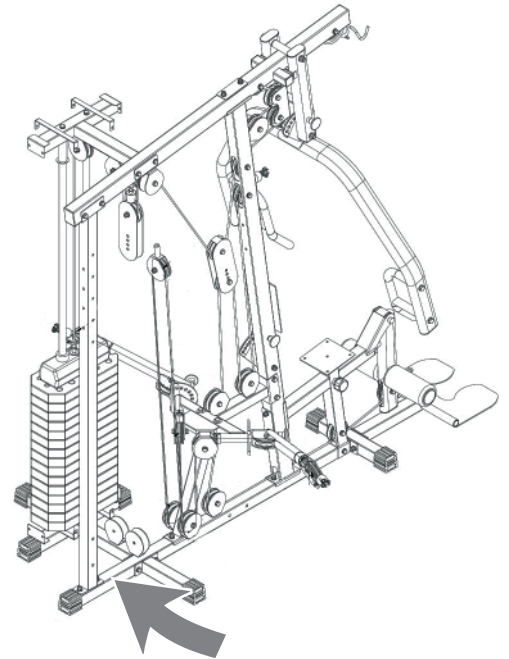

Enter the serial number in the appropriate field.

Serial number:

Brand / Category:

Model Name:

Article Number:

7.2 Parts List Part A

No.	Name	Qty.
1	BASE FRAME	1
2	FRONT BASE TUBE	1
3	LOW ROW CONNECTOR	1
4	FOOT PLATE	1
5	REAR UPRIGHT	1
6	BOTTOM CROSS CONNECTOR	1
7	SIDE ROW CONNECTOR	1
8	FRONT UPRIGHT	1
9	TOP FRAME	1
10	FIXING BRACKET	1
11	REAR CONNECT	1
12	SINGLE PULLEY BLOCK	1
13	CABLE ARM ASSEMBLE	1
14	CABLE ARM	2
15	AXLE COLLAR	2
16	PRESS ARM	1
17	PRESS ARM SELECTOR	1
18	HAND GRIP (LEFT)	1
19	HAND GRIP (RIGHT)	1
20	SEAT CUSHION SUPPORT	1
21	LEG EXTENSION	1
22	CUSHION SUPPORT	1
23	ROTATIONAL PULLEY BLOCK	2
24	BACK CUSHION SUPPORT	1
25	IRON SHELL (LEFT)	1
26	IRON SHELL (RIGHT)	1
27	ADJUSTABLE PULLEY BLOCK	2
28	GUIDE ROD	2
29	SELECTOR ROD	1
30	LAT BAR	1
31	PIVOT AXLE	2

32	PULL PIN	2
33	GYRO WHEEL	2
34	BUSHING	2
35	INSERT PIN	2
36	DOUBLE - THREAD SCREW	2
37	ROUND TUBE	1
38	INTENSIFY PLATE (1)	1
39	INTENSIFY PLATE (2)	2
40	INTENSIFY PLATE (3)	1
41	PULLEY BLOCK	4
42	JOINT PLATE	3
43	BIG WASHER	2
44	IRON BUSHING	4
45	PLASTIC BUSHING	2
46	HAND GRIP OF CABLE ARM	2
47	BACK CUSHION	1
48	SEAT CUSHION	1
49	HEADREST CUSHION	1
50	WEIGHT PLATE	15
51	TOP PLATE	1
79	SQUARE END CAP - 50	7
80	BUFFER (A)	1
81	SELECTOR PIN	1
82	BUFFER (B)	4
83	STABILIZER	1
84	BUFFER (C)	2
85	YELLOW HANDLE	4
86	FAST PIN (YELLOW)	1
87	SQUARE BUSHING-45	1
88	FOAM ROLLER (WITH PU JACKET)	2
89	BIG PLUG FOR FOAM	2
90	PLASTIC BUSHING	10
90S	PLASTIC BUSHING (SHOTER THAN PART 90)	2
91	PULLEY - Ø90	29

92	PULLEY - Ø100	1
93	HOIST HOOK	4
94	HOLE PLUG	27
95	SQUARE NECK BOLT M10×60 + WASHER + LOCK NUT	6
96	BOLT M10×75 + TWO WASHERS + LOCK NUT	11
97	SQUARE NECK BOLT M10×60	2
98	BOLT M10×70 + TWO WASHERS + LOCK NUT	5
99	BOLT M10×90 + TWO WASHERS + LOCK NUT	4
100	CROSS RECESSED COUNTERSUNK HEAD SCREW M10×65 + TWO NUTS	1
101	BOLT M10×20 + WASHER	2
102	CROSS PAD HEAD SCREW M6×10	1
103	BOLT M10×65 + BIG WASHER + WASHER + LOCK NUT	2
104	CROSS RECESSED COUNTERSUNK HEAD SCREWS M10×40	1
105	BOLT M10×80 + TWO WASHERS + LOCK NUT + TWO NELON CAPS	1
106	SET SCREW M6×6	4
107	BOLT M12×20 + WASHER	4
108	TWO WASHERS 12 + TWO LOCK NUTS M12	2
110	BOLT M10×50 + TWO WASHERS + LOCK NUT	6
111	BOLT M10×85 + TWO WASHERS + LOCK NUT	1
112	BOLT M10×55 + TWO WASHERS + LOCK NUT	1
113	BOLT M10×125 + TWO WASHERS + LOCK NUT	1
114	BOLT M6×45 + TWO WASHERS + LOCK NUT	2
115	BOLT M8×16 + WASHER	18
116	BOLT M8×85 + WASHER	2
117	BOLT M6×20 + WASHER	4
118	CHAIN	1
119	CABLE WITH ONE BALL	1
120	CABLE WITH TWO BALL (PARTS OF ONE BALL)	1
121	CABLE WITH TWO BALL AND PARTS	1
122	CABLE WITH NO BALL	1
123	ROUND PLUG - Ø25	2
124	ROUND BUSHING - Ø50	2
125	OVAL PLUG - 8040	5
126	ROUND PLUG - Ø30	2

127	RECTANGLE PLUG - 7050	2
128	SQUARE PLUG - 38	2
129	SQUARE PLUG - 25	2
130	SPRING	4
131	FOAM TUBE LAT BAR	2
132	CIRCLIPS FOR SHAFT	2
148	BIG WASHER 12	1
149	CORE PULLING RIVET	12
150	WASHER 10 + LOCK NUT M10	1
151	PROTECT PAD	8
152	BOLT M10×45 + TWO WASHERS + LOCK NUT	15
154	RUBBER PLATE	2
155	CROSS SOCKET HEAD SCREWS M5×10	4
156	SQUARE NECK BOLT M10×60	8
157	WASHER 10	101
158	LOCK NUT M10	54
159	BOLT M10×75	11
160	BOLT M10×70	5
161	BOLT M10×90	4
162	CROSS RECESSED COUNTERSUNK HEAD SCREW M10×65	1
163	HEXAGON NUT M10	2
164	BOLT M10×20	2
165	CROSS PAD HEAD SCREW M6×10	1
166	BIG WASHER 10	2
167	CROSS RECESSED COUNTERSUNK HEAD SCREWS M10×40	1
168	BOLT M10×80	1
169	NELON CAP 10	2
170	SET SCREW M6×6	4
171	BOLT M12×20	4
172	WASHER 12	8
173	LOCK NUT M12	4
174	BOLT M10×50	6
175	BOLT M10×85	1
175	BOLT M10×55	1

177	BOLT M10×125	1
178	BOLT M6×45	2
179	WASHER 6	8
180	LOCK NUT M6	2
181	BOLT M8×16	18
182	WASHER 8	20
183	BOLT M8×85	2
184	BOLT M6×20	4
194	BOLT M10×65	2
195	BOLT M10×45	15
197	CROSS SOCKET HEAD SCREWS M5×10	4

7.3 Exploded Drawing Part A

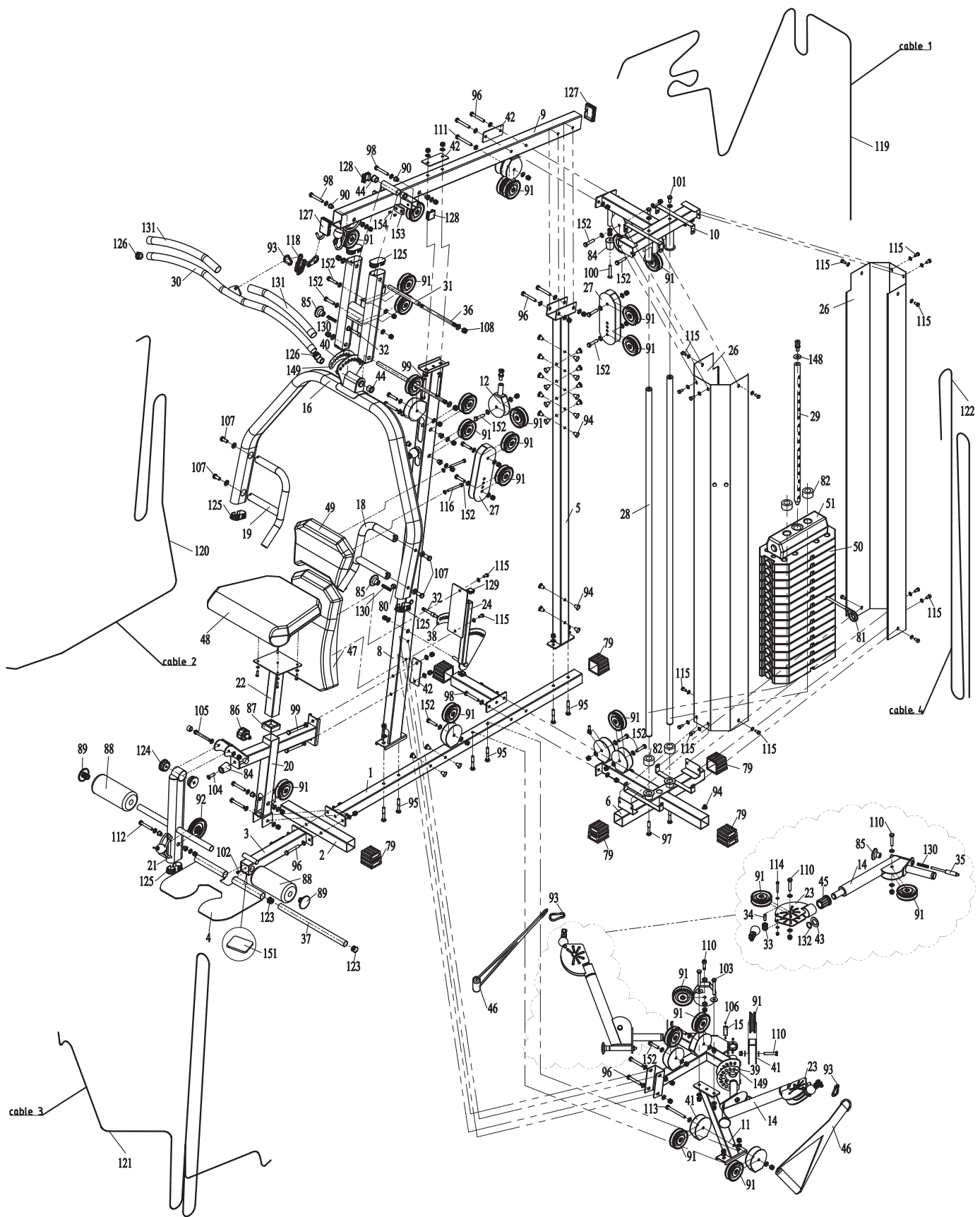

7.4 Parts List Part B

No.	Name	Qty.
52	CONNECTING TUBE (A)	1
53	CONNECTING TUBE (B)	1
2	FRONT BASE TUBE	1
54	RIGHT ARMREST	1
55	LEFT ARMREST	1
56	LEG EXTENSION BASE FRAME	1
57	SUPPORT	1
58	UPRIGHT SUPPORT	1
59	SEAT SUPPORT	1
60	BACK SUPPORT	1
61	ROTATE BUSHING	2
62	FOOT EXTENSION POLE (1)	1
63	FOOT EXTENSION POLE (2)	1
64	FOOT EXTENSION SUPPORT	1
65	FOOT PLATE	1
42	JOINT PLATE	5
66	FOAM CHECK RING	2
67	SMALL SEAT CUSHION	1
47	BACK CUSHION	1
79	SQUARE END CAP - 50	3
91	PULLEY - Ø90	6
95	SQUARE NECK BOLT M10×60 + WASHER + LOCK NUT	2
96	BOLT M10×75 + TWO WASHERS + LOCK NUT	12
98	BOLT M10×70 + TWO WASHERS + LOCK NUT	2
133	BOLT M10×115 + TWO WASHERS + LOCK NUT	2
52	CONNECTING TUBE (A)	1
53	CONNECTING TUBE (B)	1
2	FRONT BASE TUBE	1
54	RIGHT ARMREST	1
55	LEFT ARMREST	1
56	LEG EXTENSION BASE FRAME	1
57	SUPPORT	1

58	UPRIGHT SUPPORT	1
59	SEAT SUPPORT	1
60	BACK SUPPORT	1
61	ROTATE BUSHING	2
62	FOOT EXTENSION POLE (1)	1
63	FOOT EXTENSION POLE (2)	1
64	FOOT EXTENSION SUPPORT	1
65	FOOT PLATE	1
42	JOINT PLATE	5
66	FOAM CHECK RING	2
67	SMALL SEAT CUSHION	1
47	BACK CUSHION	1
79	SQUARE END CAP - 50	3
91	PULLEY - Ø90	6
95	SQUARE NECK BOLT M10×60 + WASHER + LOCK NUT	2
96	BOLT M10×75 + TWO WASHERS + LOCK NUT	12
98	BOLT M10×70 + TWO WASHERS + LOCK NUT	2
133	BOLT M10×115 + TWO WASHERS + LOCK NUT	2
134	SQUARE BLOCK	1
135	CROSS SOCKET HEAD SCREWS M10×20	1
136	BOLT M10×135 + TWO WASHERS + LOCK NUT	2
137	HEX SOCKET HEAD SCREWS M10×40+ WASHER + LOCK NUT	2
117	BOLT M6×20 + WASHER	4
86	FAST PIN (YELLOW)	1
115	BOLT M8×16 + WASHER	2
110	BOLT M10×50 + TWO WASHERS + LOCK NUT	1
138	BOLT M8×30 +LOCK NUT	1
101	BOLT M10×20 + WASHER	1
139	HEX SOCKET HEAD SCREWS M8×20	2
140	FOAM TUBE - Ø32*125	2
141	SQUARE PLUG - 50	1
124	ROUND BUSHING - Ø50	4
142	RECTANGLE PLUG - 3020	6

7.5 Exploded Drawing Part B

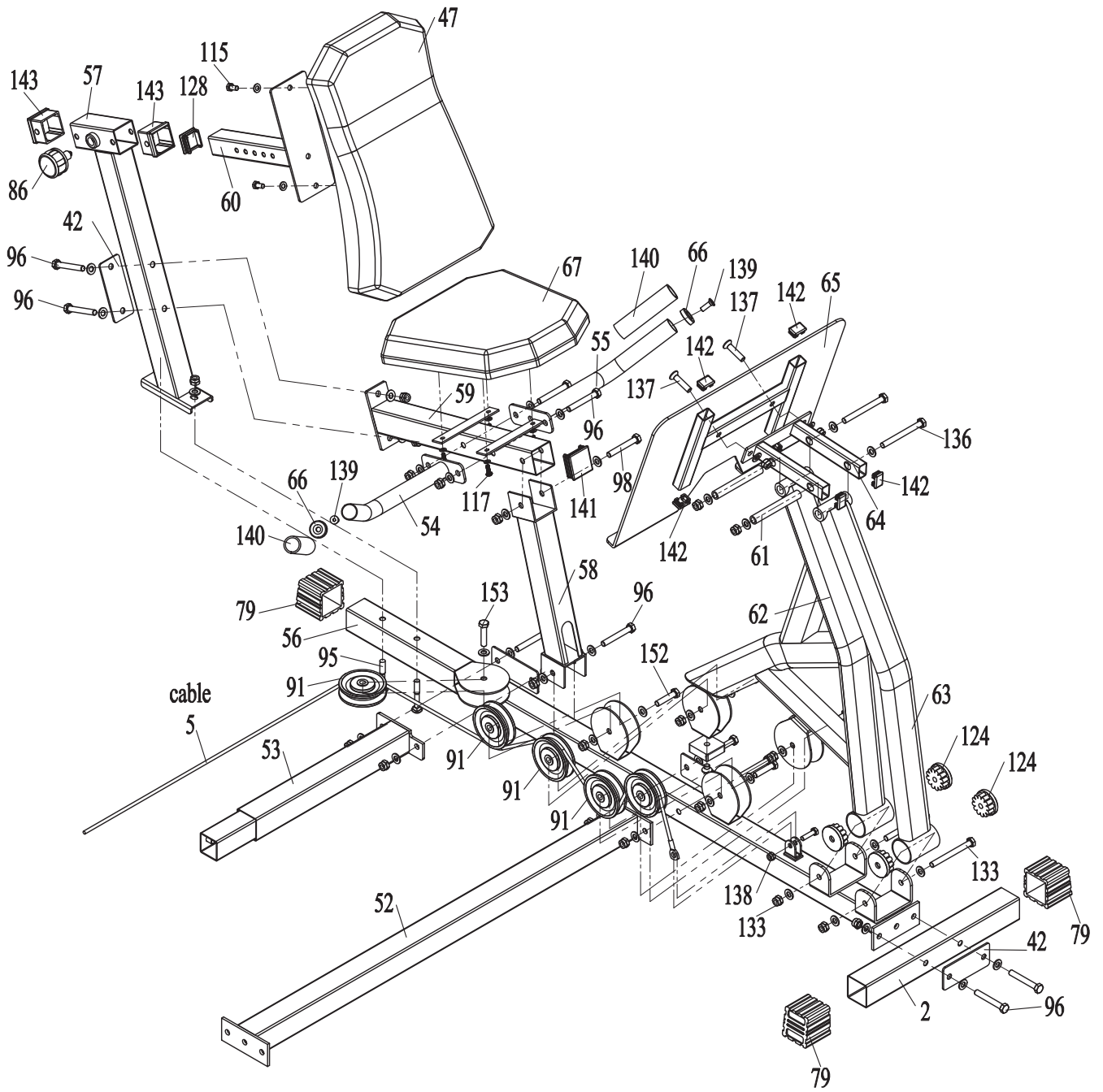

7.6 Parts List Part C

No.	Name	Qty.
68	UPRIGHT HAND HANDLE	2
69	LEFT SUPPORT POLE SET	1
70	RIGHT SUPPORT POLE SET	1
71	FOOT EXERCISE	1
66	FOAM CHECK RING	4
72	ARMREST CUSHION	2
47	BACK CUSHION	1
98	BOLT M10×70 + TWO WASHERS + LOCK NUT	2
139	HEX SOCKET HEAD SCREWS M8×20	4
144	BOLT M10×115 + TWO WASHERS + LOCK NUT	2
145	BOLT M8×70 + WASHER	6
140	FOAM TUBE - Ø32*125	2
146	FOAM TUBE - Ø32*170	2
147	BOLT M12×25 + WASHER	2
79	SQUARE END CAP - 50	1
157	WASHER 10	8
158	LOCK NUT M10	4
160	BOLT M10×70	2
172	WASHER 12	2
182	WASHER 8	6
185	BOLT M10×115	2
191	HEX SOCKET HEAD SCREWS M8×20	4
192	BOLT M8×65	6
193	BOLT M12×25	2

7.7 Exploded Drawing Part C

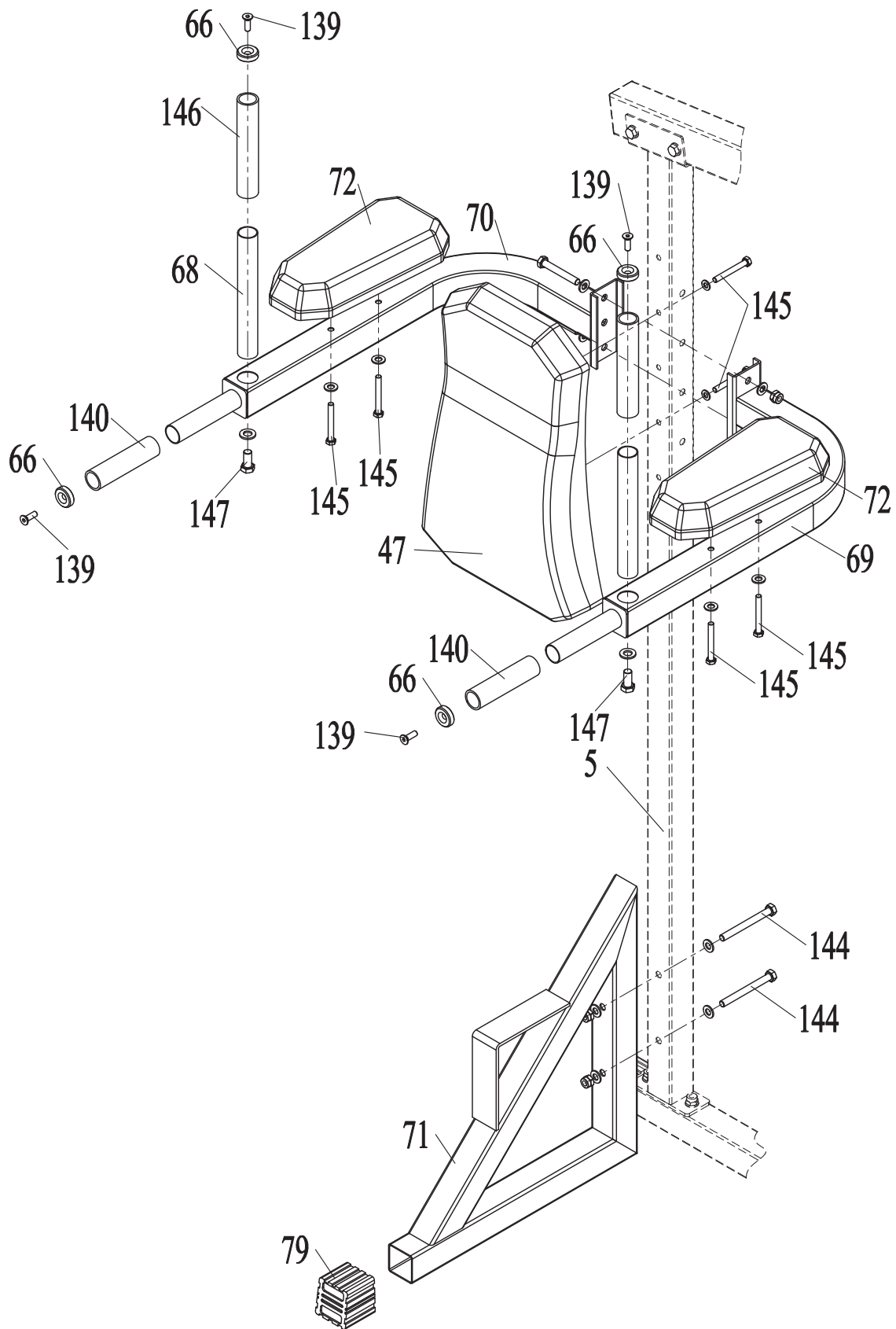

7.8 Parts List Part D

No.	Name	Qty.
73	LOW ROW BAR	1
74	ABDOMINAL STRAP	1
75	HOOK	3
76	ANKLE STRAP	1
77	CANTEEN RACK SUPPORT	1
78	CANTEEN RACK	1
93	HOIST HOOK	3
102	CROSS PAD HEAD SCREW M6×16	3
118	CHAIN	1
125	OVAL PLUG - 8040	2
126	ROUND PLUG - Ø30	2
140	FOAM TUBE - Ø32*125	2
190	CROSS PAD HEAD SCREW M6×16	3

7.9 Exploded Drawing Part D

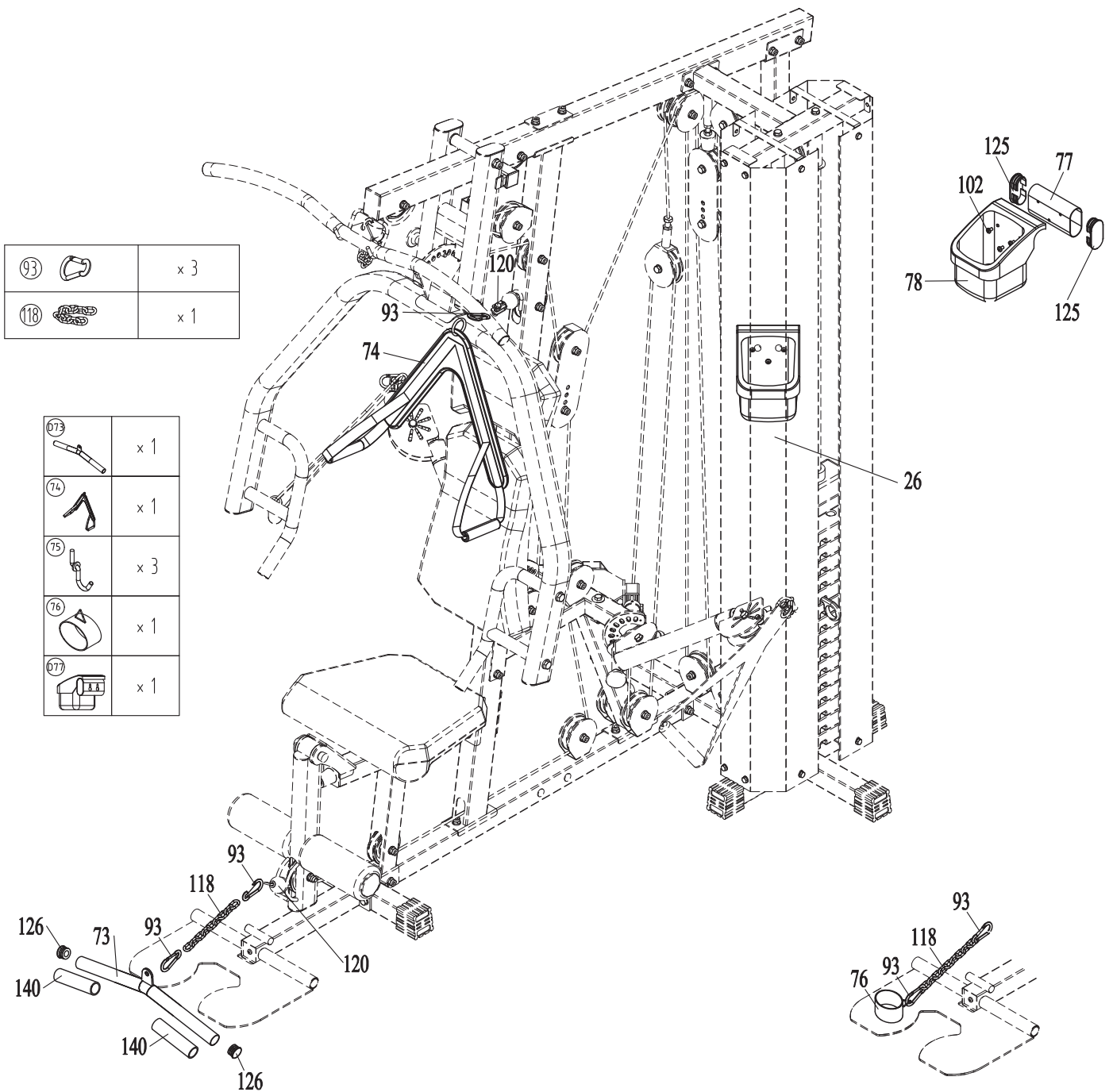

Products from TAURUS® are subject to strict quality control. However, if a fitness equipment purchased from us does not work perfectly, we take it very seriously and ask you to contact our customer service as indicated. We are happy to help you by phone via our service hotline.

Error Descriptions

Your fitness equipment is developed for long-term, high-quality training. However, should a problem arise, please first read the operating instructions. For further assistance, please contact your contract partner or call our service hotline. To ensure your problem is solved as quickly as possible, please describe the defect as exactly as possible.

In addition to the statutory warranty, we provide a warranty for every fitness equipment purchased from us according to the following provisions.

Your statutory rights are not affected.

Warrantee

The warrantee is the first/original buyer and/or any person who received a newly purchased product as a gift from the original buyer.

Warranty period

The warranty periods, shown on our web shop, begin on delivery of the fitness equipment. The respective warranty periods for your equipment can be found on its product website.

Repair Costs

According to our choice, there will either be a repair, a replacement of individual damaged parts or a complete replacement. Spare parts, that have to be mounted while assembling the equipment, have to be replaced by the warrantee personally and are not a part of repair. After the expiration of the warranty period, the responsibility for parts costs, repair costs, installation costs and delivery costs lies with the warranty holder.

The terms of use are defined as follows:

- + Home use: solely for private use in private households up to 3 hours per day
- + Semi-professional use: up to 6 hours per day (e. g. rehabilitation centres, hotels, clubs, company gyms)
- + Professional use: more than 6 hours per day (e. g. commercial gyms)

Warranty Service

Within the warranty period, equipment which develops faults as a result of material or manufacturing defects, will be repaired or replaced at our discretion. Ownership of equipment or parts of equipment which have been replaced is transferred to us. The warranty period is not extended nor does a new warranty period begin following repair or replacement under the warranty.

Warranty Conditions

For the warranty to be valid, the following steps must be taken:

Please contact our customer service by email or phone. If the product under warranty has to be sent in for repair, the seller bears costs. After expiry of the warranty, the buyer bears the costs of transport and insurance. If the fault is covered by our warranty, you will receive a new or repaired equipment in return.

Warranty claims are invalid in case of damage resulting from:

- + misuse or improper handling
- + environmental influences (moisture, heat, electrical surge, dust, etc.)
- + failure to follow the current safety measures for the equipment
- + failure to follow the operating instructions
- + use of force (e. g. hitting, kicking, falling)
- + interventions which were not carried out by one of our authorized service centres
- + unauthorised repair attempts

Proof of Purchase and Serial Number

Please make sure that you are able to provide the appropriate receipt when claiming on your warranty. So that we can clearly identify the model of your equipment, and for the purposes of our quality control, you will need to give the serial number of your equipment, when contacting the service team. Where possible please have your serial number and your customer number ready when you call our service hotline. It will help us to deal with your request swiftly.





































If you cannot find the serial number on your fitness equipment, our service team is at your disposal to offer further information.

Service outside of the Warranty Period

We are also happy to issue an individual cost estimate if there is a problem with your fitness equipment after the warranty has expired, or in cases which do not fall under the terms of the warranty, e. g. normal wear and tear. Please contact our customer service team to find a quick and cost-effective solution to your problem. In such a case you will be responsible for the delivery costs.

Communication

Many problems can be solved just by speaking to us as your specialist supplier. We know how important it is to you as a user of the fitness equipment to have problems solved quickly and simply, so you can enjoy working out with minimal interruption. For that reason, we also want to resolve your queries quickly and in a straightforward manner. Thus, please always keep your customer number and the serial number of the faulty equipment handy.

DE	DK	UK
<p>TECHNIK</p> <p> +49 4621 4210-900</p> <p> +49 4621 4210-698</p> <p> technik@fitshop.de</p> <p> Öffnungszeiten entnehmen Sie unserer Homepage.</p> <p>SERVICE</p> <p> 0800 20 20277 (kostenlos)</p> <p> 04621 4210 - 0</p> <p> info@fitshop.de</p> <p> Öffnungszeiten entnehmen Sie unserer Homepage: https://stg.fit/statita</p>	<p>TEKNIK OG SERVICE</p> <p> 80 90 16 50</p> <p>+49 4621 4210-945</p> <p> info@fitshop.dk</p> <p> Åbningstider kan findes på hjemmesiden: https://stg.fit/statit7</p> <p>FR</p> <p>TECHNIQUE & SERVICE</p> <p> +33 (0) 189 530984</p> <p>+49 4621 42 10 933</p> <p> info@fitshop.fr</p> <p> Vous trouverez les heures d'ouverture sur notre site Internet: https://stg.fit/statit4</p>	<p>CUSTOMER SUPPORT</p> <p> 00800 2020 2772</p> <p>+494621 4210 944</p> <p> info@fitshop.co.uk</p> <p> You can find the opening hours on our homepage: https://stg.fit/statitc</p> <p>BE</p> <p>TECHNIQUE & SERVICE</p> <p> 02 732 46 77</p> <p>+49 4621 4210 933</p> <p> info@fitshop.be</p> <p> Vous trouverez les heures d'ouverture sur notre site Internet: https://stg.fit/statit8</p>
ES	NL	INT
<p>TECNOLOGÍA Y SERVICIOS</p> <p> 911 238 029</p> <p> info@fitshop.es</p> <p> Consulta nuestro horario de apertura en la página web: https://stg.fit/statit5</p>	<p>TECHNISCHE DIENST & SERVICE</p> <p> +31 172 619961</p> <p> service@fitshop.nl</p> <p> De openingstijden vindt u op onze homepage: https://stg.fit/statit3</p>	<p>TECHNICAL SUPPORT & SERVICE</p> <p> +49 4621 4210-944</p> <p> service-int@fitshop.de</p> <p> You can find the opening hours on our homepage: https://stg.fit/statita</p>
PL	AT	CH
<p>DZIAŁ TECHNICZNY I SERWIS</p> <p> 22 307 43 21</p> <p>+49 4621 42 10-948</p> <p> info@fitshop.pl</p> <p> Godziny otwarcia można znaleźć na stronie głównej: https://stg.fit/statit6</p>	<p>TECHNIK & SERVICE</p> <p> 0800 20 20277 (Freecall)</p> <p>+49 4621 42 10-0</p> <p> info@fitshop.at</p> <p> Öffnungszeiten entnehmen Sie unserer Homepage: https://stg.fit/statitb</p>	<p>TECHNIK & SERVICE</p> <p> 0800 202 027</p> <p>+49 4621 42 10-0</p> <p> info@fitshop.ch</p> <p> Öffnungszeiten entnehmen Sie unserer Homepage: https://stg.fit/statit9</p>

Please find a detailed overview including address and opening hours for all stores of the Fitshop Group in Germany and abroad on the following website:

www.fitshop.com/en/stores

WE LIVE FITNESS

WEBSHOP AND SOCIAL MEDIA

Fitshop is Europe's largest specialist store for home fitness equipment with currently over 70 stores and one of the world's most renowned online mail order companies for fitness equipment. Private customers order via the 25 web shops in the respective national language or have their desired equipment assembled on site. In addition, the company supplies fitness studios, hotels, sports clubs, companies and physio practices with professional equipment for endurance and strength training.

Fitshop offers a wide range of fitness equipment from renowned manufacturers, high-quality in-house developments and comprehensive services, such as a build-up service and sports scientific advice before and after the purchase. The company employs numerous sports scientists, fitness trainers and competitive athletes.

Visit us also on our social media platforms or our blog!

	www.fitshop.co.uk www.fitshop.de/blog
-----------------------------------------------------------------------------------	--------------------------------------------------------------------------------------------------------------------------

	www.facebook.com/fitshop.co.uk
-----------------------------------------------------------------------------------	------------------------------------------------------------------------------------

	www.instagram.com/fitshop_uk
------------------------------------------------------------------------------------	--------------------------------------------------------------------------------

	www.youtube.com/@fitshop_uk
-------------------------------------------------------------------------------------	------------------------------------------------------------------------------

TAURUS

 cardiostrong

BODYCRAFT

 cardiojump

 **DUKEFITNESS**

DARWIN

Notes

TAURUS®