

TAURUS®

Operating Instructions

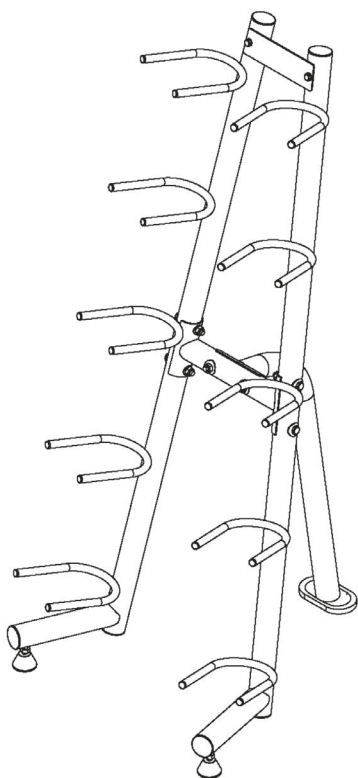

Art. No. TF-MBS

TFMBS.01.01

1 GENERAL SAFETY INSTRUCTIONS

1.1 Personal Safety

⚠ DANGER

- + Before you start using the equipment, you should consult your physician that this type of exercise is suitable for you from a health perspective. Particularly affected are persons who: have a hereditary disposition to high blood pressure or heart disease, are over the age of 45, smoke, have high cholesterol values, are overweight and/or have not exercised regularly in the past year. If you are under medical treatment that affects your heart rate, medical advice is absolutely essential.
- + Note that excessive training can seriously endanger your health. Please also note that heart rate monitoring systems can be inaccurate. If you notice any signs of weakness, nausea, dizziness, pain, shortness of breath, or other abnormal symptoms, stop exercising immediately and seek advice from your doctor if necessary.

⚠ WARNING

- + This equipment may not be used by children under the age of 14.
- + Children should not be allowed unsupervised access to the equipment.
- + People with disabilities must have a medical license and must be under strict observation when using the equipment.
- + The equipment is strictly for use by one person at a time
- + Keep your hands, feet and other body parts, hair, clothing, jewellery and other objects well clear of moving parts.

⚠ CAUTION

- + Make sure that nobody is within the range of motion of the equipment during training so as not to endanger you or other persons.

▶ ATTENTION

- + Do not insert any objects of any kind into the openings of the device.
- + Do not wear jewellery like rings while using the punching ball.

1.2 Set-Up Place

⚠ WARNING

- + Do not place the equipment in main corridors or escape routes.
- + To prevent fire, do not place the device near or in areas with high heat (e.g. near a heater).

⚠ CAUTION

- + Choose the set-up place so that there is sufficient space around the product. Please note that the product requires sufficient space to the rear when in the reclined position.

▶ ATTENTION

- + The device may only be used in one building, in sufficiently tempered and dry rooms (ambient temperatures between 10°C and 35°C). The equipment should not be used outdoors or in rooms with high humidity (over 70%) like swimming pools
- + To avoid fading or faster wear of the cover, do not place the product in places with direct sunlight and/or high heat.

2 TECHNICAL DATA













| | |
|---------------------------------------|-----------------------|
| Filling with sand or water: | 30 kg |
| Punching ball height: | 27 cm |
| Punching ball diameter: | 21 cm |
| Total height: | approx. 154 cm |
| Product weight (incl. packaging): | 5.5 kg |
| Packaging dimensions (LxWxH) approx.: | 48 cm x 26 cm x 48 cm |

3 PARTS LIST

| No. | Name | Qty. |
|-----|-----------------|------|
| 1 | RIGHT SUPPORT | 1 |
| 2 | LEFT SUPPORT | 1 |
| 3 | REAR SUPPORT | 1 |
| 4 | JOINT TUBE | 1 |
| 5 | JOINT PLATE | 1 |
| 6 | ADJUSTABLE FOOT | 2 |
| 7 | RUBBER PAD | 1 |
| 8 | ROUND PLUG-16 | 20 |
| 9 | ROUND PLUG-50 | 6 |
| 10 | BOLT M8*16 | 2 |
| 11 | BOLT M10*70 | 6 |
| 12 | WASHER 8 | 2 |
| 13 | ARC WASHER 10 | 12 |
| 14 | LOCK NUT M10 | 6 |

Medicine ball stand Pro

4 SCOPE OF DELIVERY

| NUMBER | DESCRIPTION | | QUANTITY |
|--------|-----------------|---|----------|
| 1 | RIGHT SUPPORT |  | 1 |
| 2 | LEFT SUPPORT |  | 1 |
| 3 | REAR SUPPORT |  | 1 |
| 4 | JOINT TUBE |  | 1 |
| 5 | JOINT PLATE |  | 1 |
| 6 | ADJUSTABLE FOOT |  | 2 |
| 7 | RUBBER PAD |  | 1 |
| 10 | BOLT M8*16 |  | 2 |
| 11 | BOLT M10*70 |  | 6 |
| 12 | WASHER 8 |  | 2 |
| 13 | ARC WASHER 10 |  | 12 |
| 14 | LOCK NUT M10 |  | 6 |

5 ASSEMBLY

1. Assemble the joint tube (4) to the right and left support (1&2) with four bolts (11), eight washers (13) and four lock nuts (14).
2. Assemble the joint plate (5) to the right and left support (1&2) with two bolts (10) and two washers (12).
3. Attach the rubber pad (7) to the rear support (3).
4. Assemble the rear support (3) to the joint tube (4) with two bolts (11), four arc washers (13) and two lock nuts (14).
5. Assemble the adjustable feet (6) to the right and left support (1&2).

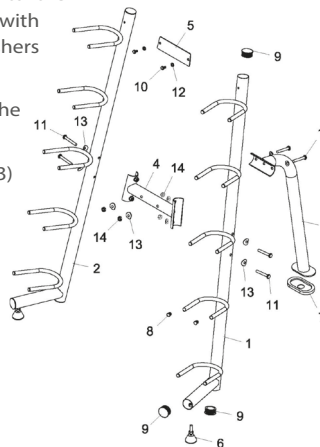

6 CARE, MAINTENANCE AND STORAGE

⚠ WARNING

The storage location should be chosen so that improper use by third parties or children can be prevented.

1. Clean the device with a dry soft cloth.
2. Store the device in the supplied carton in a dry environment.

7 WARRANTY INFORMATION

Training equipment from Taurus® is subject to strict quality control. However, if a fitness equipment purchased from us does not work perfectly, we take it very seriously and ask you to contact our customer service as indicated. We are happy to help you by phone via our service hotline.

Warranty period

The warranty periods, shown on our web shop, begin on delivery of the fitness equipment. The respective warranty periods for your equipment can be found on its product website.

Please refer to the website of your Taurus® device for the exact warranty conditions.

Contact

DE

Technical Support

☎ +49 4621 4210-900

✉ technik@sport-tiedje.de

Service

☎ 0800 20 20 277

(freecall)

✉ info@sport-tiedje.de

UK

Technical Support

☎ +44 141 876 3986

✉ support@powerhousefitness.co.uk

Service

☎ +44 141 876 3972

FR

Technical Support & Service

☎ +33 (0) 172 770033

+49 4621 4210-933

✉ service-france@fitshop.fr

DK

Technical Support & Service

☎ 80 90 16 50

+49 4621 4210-945

✉ info@fitshop.dk

INT

Technical Support & Service

☎ +49 4621 4210-944

✉ service-int@sport-tiedje.de

BE

Technical Support & Service

☎ 02 732 46 77

+49 4621 42 10-932

✉ info@fitshop.be

NL

Technical Support & Service

☎ +31 172 619961

✉ info@fitshop.nl

AT

Technical Support & Service

☎ 0800 20 20 277

(freecall)

+49 4621 42 10-0

✉ info@sport-tiedje.at

CH

Technical Support & Service

☎ 0800 202 027

+49 4621 42 10-0

✉ info@sport-tiedje.ch

PL

Technical Support & Service

☎ 22 307 43 21

+49 4621 42 10-948

✉ info@fitshop.pl