

TAURUS®

Assembly and Operating Instructions

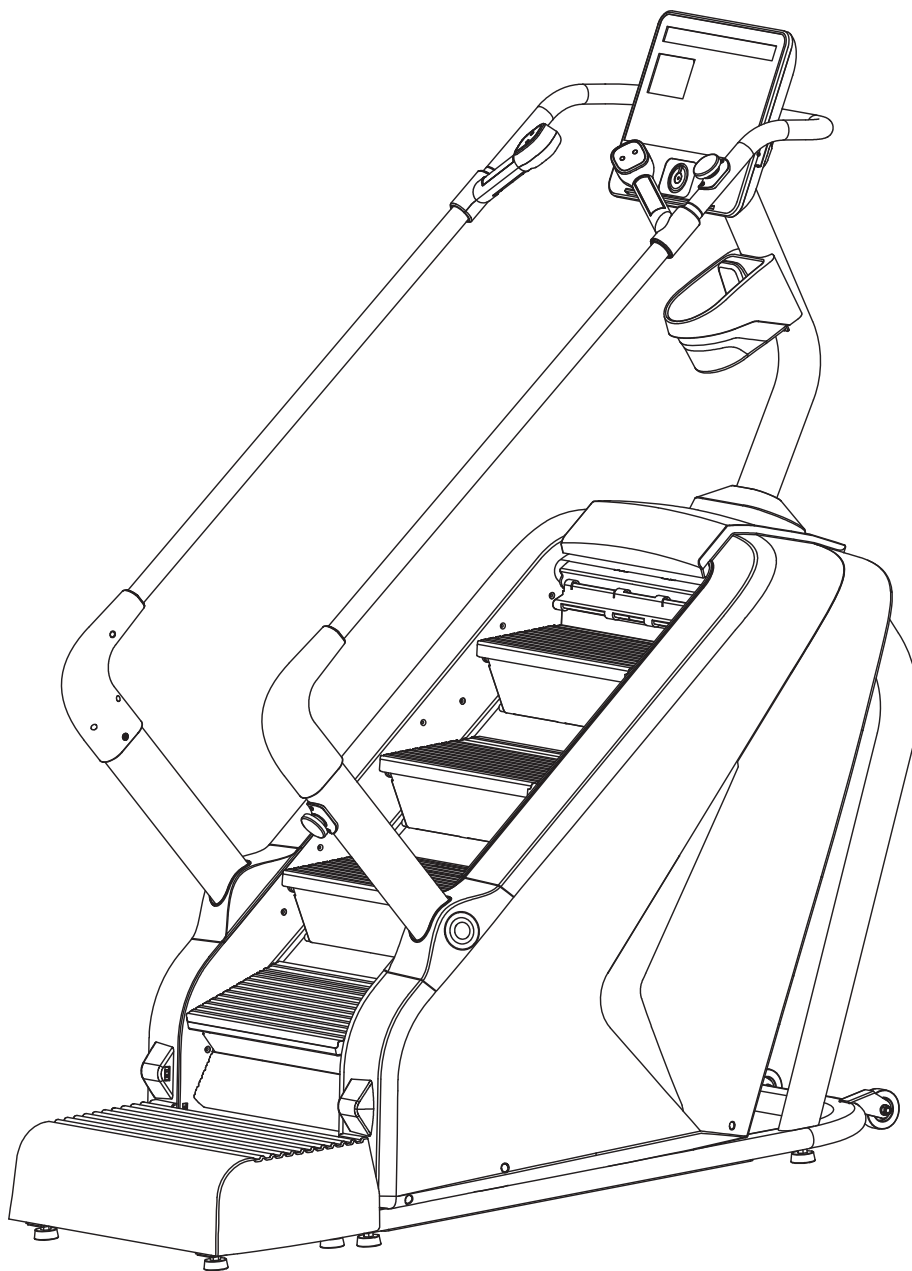

max. 180 kg



~ 60 Min.



185 kg

L 176 | W 80 | H 211

FSTFST105.01.01

Art.-No. TF-ST105

Taurus Stair Trainer ST10.5

Content

1	GENERAL INFORMATION	8
1.1	Technical Data	8
1.2	Personal Safety	9
1.3	Electrical Safety	10
1.4	Set-Up Place	11
2	ASSEMBLY	12
2.1	General Instructions	12
2.2	Scope of Delivery	12
2.3	Assembly	14
3	OPERATING INSTRUCTIONS	22
3.1	Console Display	22
3.2	Button Functions	24
3.3	Turning On the Equipment and Initial Settings	28
3.4	Training Programmes	29
3.4.1	Quick Start (MANUAL)	29
3.4.2	Countdown Programmes (HEIGHT, CALORIES, TIME)	30
3.4.3	Pre-set Programmes (PROG.)	31
3.4.4	User-defined Programmes (CUSTOM)	33
3.5	Body Mass Index (FAT)	34
3.6	Bluetooth	34
4	STORAGE AND TRANSPORT	35
4.1	General Instructions	35
4.2	Transportation Wheels	35
5	TROUBLESHOOTING, CARE AND MAINTENANCE	36
5.1	General Instructions	36
5.2	Faults and Fault Diagnosis	36
5.3	Error Codes and Troubleshooting	37
5.4	Maintenance and Inspection Calendar	38
6	DISPOSAL	38
7	RECOMMENDED ACCESSORIES	39

8	ORDERING SPARE PARTS	40
8.1	Serial Number and Model Name	40
8.2	Parts List	41
8.3	Exploded Drawing	43
9	WARRANTY	44
10	CONTACT	46

Dear customer,

Thank you for choosing a high-quality equipment of the brand TAURUS®. Taurus offers sports and fitness equipment for the sophisticated home sport and the equipment of fitness studios and business customers. With Taurus fitness equipment, the focus is on what sport is all about: maximum performance! Therefore, the equipment is developed in close consultation with athletes and sports scientists. Because athletes know best what makes perfect fitness equipment.

Further information can be found at www.fitshop.com

Intended Use

The equipment may only be used for its intended purpose.

This fitness equipment is suitable for home use, semi-professional use and commercial or professional use. The semi-professional sector includes, for example, institutional facilities such as hospitals, schools, hotels and associations. Professional use refers to commercial use, e.g. in a fitness studio.

Legal Notice

Fitshop GmbH
Europe's No. 1 for home fitness

International Headquarters
Flensburger Straße 55
24837 Schleswig
Germany

Management:
Christian Grau
Sebastian Campmann
Dr. Bernhard Schenkel
No. HRB 1000 SL
Local Court Flensburg
European VAT Number: DE813211547

Disclaimer

© TAURUS is a registered brand of the company Fitshop GmbH. All rights reserved. Any use of this trademark without the explicit written permission of Fitshop is prohibited.

Product and manual are subject to change. Technical data can be changed without advance notice.

FITSHOP

Europe's No.1 for Home Fitness

ABOUT THIS MANUAL

Please carefully read the entire manual before installation and first use. The manual will help you to quickly set up the system and explains how to safely use it. Make sure that all persons exercising with the equipment (especially children and persons with physical, sensory, mental or motor disabilities) are informed about this manual and its contents in advance. In case of doubt, responsible persons must supervise the use of the equipment.

Due to ongoing changes and software optimisations, the manual may have to be updated. If you notice any discrepancies during assembly or use, please refer to the manual uploaded to the webshop. The latest manual is always available there.



This equipment has been manufactured according to the latest safety knowledge. As far as possible, potential safety hazards which could cause injury have been eliminated. Make sure to carefully follow the instructions and that all parts are securely in place. If required, read through the instructions again to correct any mistakes.

Training devices must be classified according to accuracy and use. Accuracy classes are only applicable to devices that display training data.

Accuracy classes

Class A: high accuracy.

Class B: medium accuracy.

Class C: low accuracy.

The use classes explain the intended use of the training device.

Use classes

Class S (studio): professional and/or commercial use.

These training devices are intended for the use in training rooms of facilities such as sports clubs, school facilities, hotels, clubs and studios whose access and supervision is specifically regulated by the owner (person with legal responsibility).

Class H (home use): use at home.

These stationary training devices are intended for the use in private homes where access to the training device is regulated by the owner (person with legal responsibility).

Please pay close attention to the safety and maintenance instructions given here. The contract partner cannot be held liable for damage to health, accidents or damage to the equipment when it is not used in accordance with these instructions.

The following safety instructions may appear in this manual:

► **ATTENTION**

This notice indicates potentially hazardous situations which, if not avoided, may result in property damage.

⚠ **CAUTION**

This notice indicates potentially hazardous situations which, if not avoided, may result in slight or minor injuries!

⚠ **WARNING**

This notice indicates potentially hazardous situations which, if not avoided, may result in death or serious injuries!

⚠ **DANGER**

This notice indicates potentially hazardous situations which, if not avoided, will result in death or serious injuries!

ⓘ **NOTICE**

This notice indicates further useful information.

Retain these instructions in a safe place for future reference, maintenance or when ordering replacement parts.

1.1 Technical Data

LED Display

- + Training time in minutes
- + Speed in levels
- + Distance/height in metres
- + Calories in kcal
- + Pulse in beats per minute (when using the hand pulse sensors or a compatible chest strap)
- + Steps
- + Pace in steps per minute

Pre-set programmes:	36
Target programmes:	3
Customized programmes:	3
Quick start:	1

Weight and Dimensions

Packaging dimensions (L x W x H) approx.:	145 cm x 84 cm x 131 cm
Set-up dimensions (L x W x H) approx.:	176 cm x 79.5 cm x 211 cm

Article weight (gross, incl. packaging) approx.:	221 kg
Article weight (net, excl. packaging) approx.:	185 kg

Maximum user weight:	180 kg
----------------------	--------

Pedal height:	23 cm
Height of highest step:	100 cm

Use class:	S
------------	---

1.2 Personal Safety

DANGER

- + Before you start using the equipment, you should consult your physician that this type of exercise is suitable for you from a health perspective. Particularly affected are persons who: have a hereditary disposition to high blood pressure or heart disease, are over the age of 45, smoke, have high cholesterol values, are overweight and/or have not exercised regularly in the past year. If you are under medical treatment that affects your heart rate, medical advice is absolutely essential.
- + Note that excessive training can seriously endanger your health. Please also note that heart rate monitoring systems can be inaccurate. If you notice any signs of weakness, nausea, dizziness, pain, shortness of breath, or other abnormal symptoms, stop exercising immediately and seek advice from your doctor if necessary.
- + The owner must communicate all warnings and instructions to the user.

WARNING

- + This equipment may not be used by children under the age of 14.
- + Children should not be allowed unsupervised access to the equipment.
- + Persons with disabilities must have a medical license and must be under strict observation when using the equipment.
- + The equipment is strictly for use by one person at a time.
- + If your equipment provides a safety key, the clip of the safety key must be attached to your clothing before starting your training. In the event of a fall, the EMERGENCY STOP of the equipment can be initiated.
- + If an emergency occurs and training has to be stopped abruptly, pull out the safety key, grab both handles, jump onto the side rails and wait until the treadmill has come to a complete stop.
- + Keep your hands, feet and other body parts, hair, clothing, jewellery and other objects well clear of moving parts.
- + During use, wear suitable sports clothing rather than loose or baggy clothing. When wearing sports shoes, make sure they have suitable soles, preferably made of rubber or other non-slip materials. Shoes with heels, leather soles, studs or spikes are unsuitable. Never exercise barefoot.

CAUTION

- + If your equipment needs to be connected to the power supply with a mains cable, make sure that the cable is not a potential tripping hazard.
- + Make sure that nobody is within the range of motion of the equipment during training so as not to endanger you or other persons.
- + Be aware that if adjustment devices are left protruding, they may impede the user's movement.

► **ATTENTION**

- + Do not insert any objects of any kind into the openings of the device.
- + To protect the equipment from use by unauthorised third parties, always remove the power cable (if existing) when not in use and store it in a safe place that is inaccessible to unauthorised persons (e.g. children).

1.3 Electrical Safety

 **DANGER**

- + In order to reduce the risk of an electric shock, always unplug the equipment from the mains socket immediately after your workout, before assembly or dismantling, and before maintenance or cleaning. Do not pull on the cable.

 **WARNING**

- + Do not leave the equipment unattended while the mains cable is plugged into the mains socket. During your absence, the mains cable must be removed from the mains socket to prevent improper use by third parties or children.
- + If the mains cable or plug is damaged or defective, contact your contract partner. Until repair, the equipment must not be used.

► **ATTENTION**

- + The equipment requires a mains connection of 220-230 V with 50 Hz mains voltage.
- + The equipment may only be connected directly to an earthed socket using the supplied mains cable. Extension cables must conform to VDE guidelines. Always completely unwind the mains cable.
- + The socket must be protected by a fuse with a minimum fuse rating of "16 A, slow blow".
- + Do not make any changes to the mains cable or the mains plug.
- + Keep the mains cable away from water, heat, oil and sharp edges. Do not route the mains cable underneath the equipment or under a carpet or rug, and do not place any objects on top of it.
- + If your purchased item is equipped with a TFT console, software updates must be carried out regularly. Follow the instructions on the console to perform the update(s).
- + The software systems on gym equipment with TFT consoles are set up only for the pre-installed apps. Do not install any additional apps.

 **NOTICE**

- + The pre-installed apps on TFT consoles are produced and provided by external manufacturers. Fitshop does not take any responsibility for the availability, functionality or contents of these apps.

1.4 Set-Up Place



WARNING

- + Do not place the equipment in main corridors or escape routes.



CAUTION

- + Make sure that there is a safety area behind the treadmill with a length of at least 2 m and a width at least equal to the width of the treadmill.
- + The training room should be well ventilated during training and not be exposed to any draughts.
- + Choose the place in which to set up the equipment such that there is enough free space/clearance to the front, the rear and to the sides of the equipment.
- + The free area in the direction from which the exercise equipment is accessed must be at least 0.6 m larger than the exercise area.
- + The set-up and mounting surface of the equipment should be flat, loadable and solid.

ATTENTION

- + The device may only be used in one building, in sufficiently tempered and dry rooms (ambient temperatures between 10°C and 35°C). The equipment should not be used outdoors or in rooms with high humidity (over 70%) like swimming pools.
- + A floor protective mat/equipment underlay can help to protect high-quality floor coverings (parquet, laminate, cork, carpets) from dents and sweat and can help to level out slight unevenness.
- + For Class S equipment, the exercise equipment may only be used in areas where access, supervision and control are specifically regulated by the owner.

Recommended free zone (all measurements shown in mm):

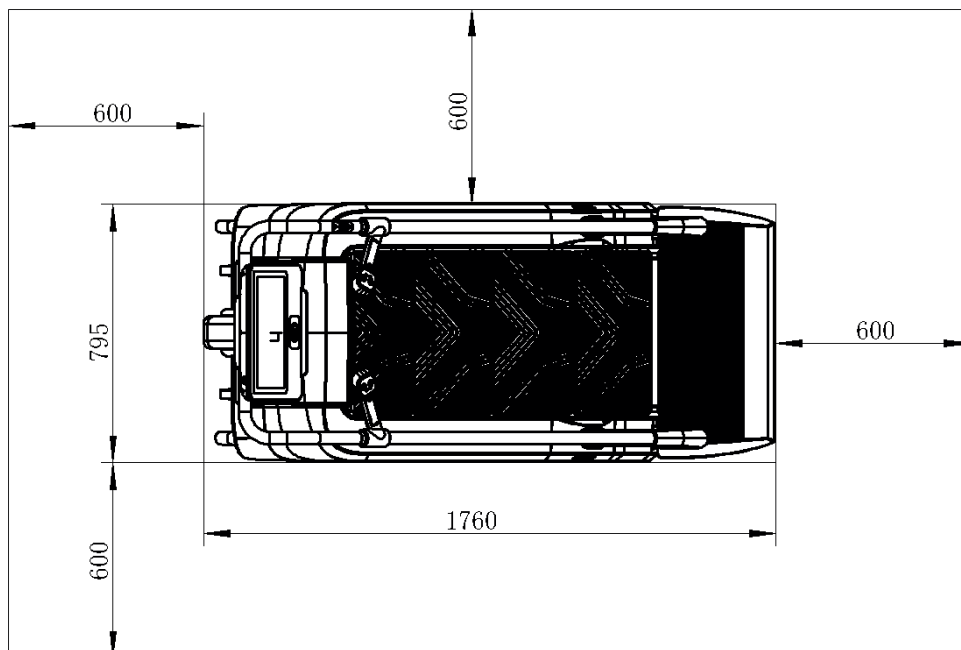

2.1 General Instructions



DANGER

- + Do not leave any tools, packaging materials such as foils or small parts lying around, as otherwise there is a danger of suffocation for children. Keep children away from the equipment during assembly.
- + Pay attention to the instructions attached to the equipment in order to reduce the risk of injuries.



CAUTION

- + Ensure to have sufficient room for movement in each direction during assembly.
- + The assembly of the equipment must be carried out by at least two adults. If in doubt, seek the help of a third technically skilled person.



ATTENTION

- + To prevent damage to the equipment and the floor, assemble the equipment on a mat or packaging board.



NOTICE

- + In order to make the assembly as simple as possible, some screws and nuts to be used can already be pre-assembled.
- + Ideally, assemble the equipment at its later set-up place.

2.2 Scope of Delivery

The scope of delivery consist of the following parts. At the beginning, check whether all parts and tools belonging to the device are included in the scope of delivery and whether damage has occurred. In the event of complaints, the contractual partner must be contacted directly.



CAUTION

If parts of the scope of delivery are missing or damaged, the assembly must not be carried out.

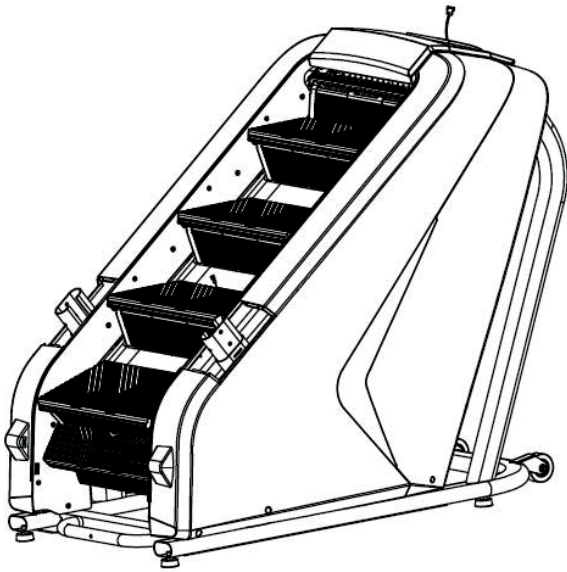

1: Main frame



5: Console Support Column

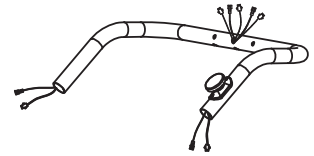

4: Rear Handrail

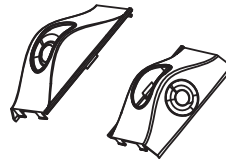

41L/R: Left and Right Decorative Cover



47: Console

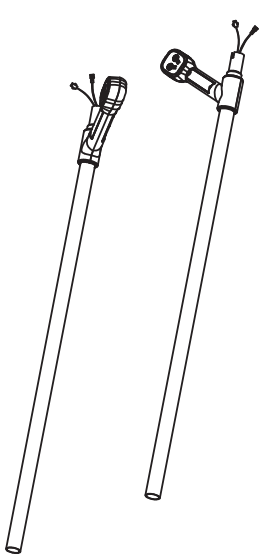

2L: Left Support Column

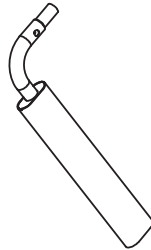

44L/R: Left and Right Exterior Decorative Cover

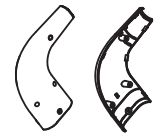

45L/R: Left and Right Interior Decorative Cover

3L/R: Left and Right Handrail

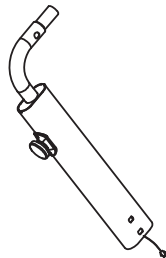

2R: Right Support Column



40: Pedal



58: Decorative Cover



48: Rear Decorative Cover



49: Bottle Holder

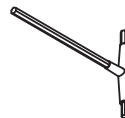

T-Type Allen Wrench

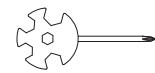

Cross Wrench



Allen Wrench (S=5 and S=6)

2.3 Assembly

Before assembly, take a close look at the individual assembly steps shown and carry out the assembly in the order given.

① NOTICE

- + First loosely screw all parts together and check that they fit properly. Tighten the screws using the tool only when you are instructed to do so.
- + If you have difficulty recognising the graphics, we recommend that you open and/or download the PDF instructions stored in the webshop on your end device (e.g. smartphone, tablet or PC). There you have the option of zooming in closer. Please note that the Adobe Acrobat Reader programme must be installed on your end device in order to open the file.

Step 1: Opening the Package and Assembly of the Pedal

1. Carefully open the package.
2. Take out all parts and place the main frame (1) on a flat ground.
3. Attach part A of the pedal (40) to part B of the main frame (1).

▶ ATTENTION

Make sure the two parts are centered.

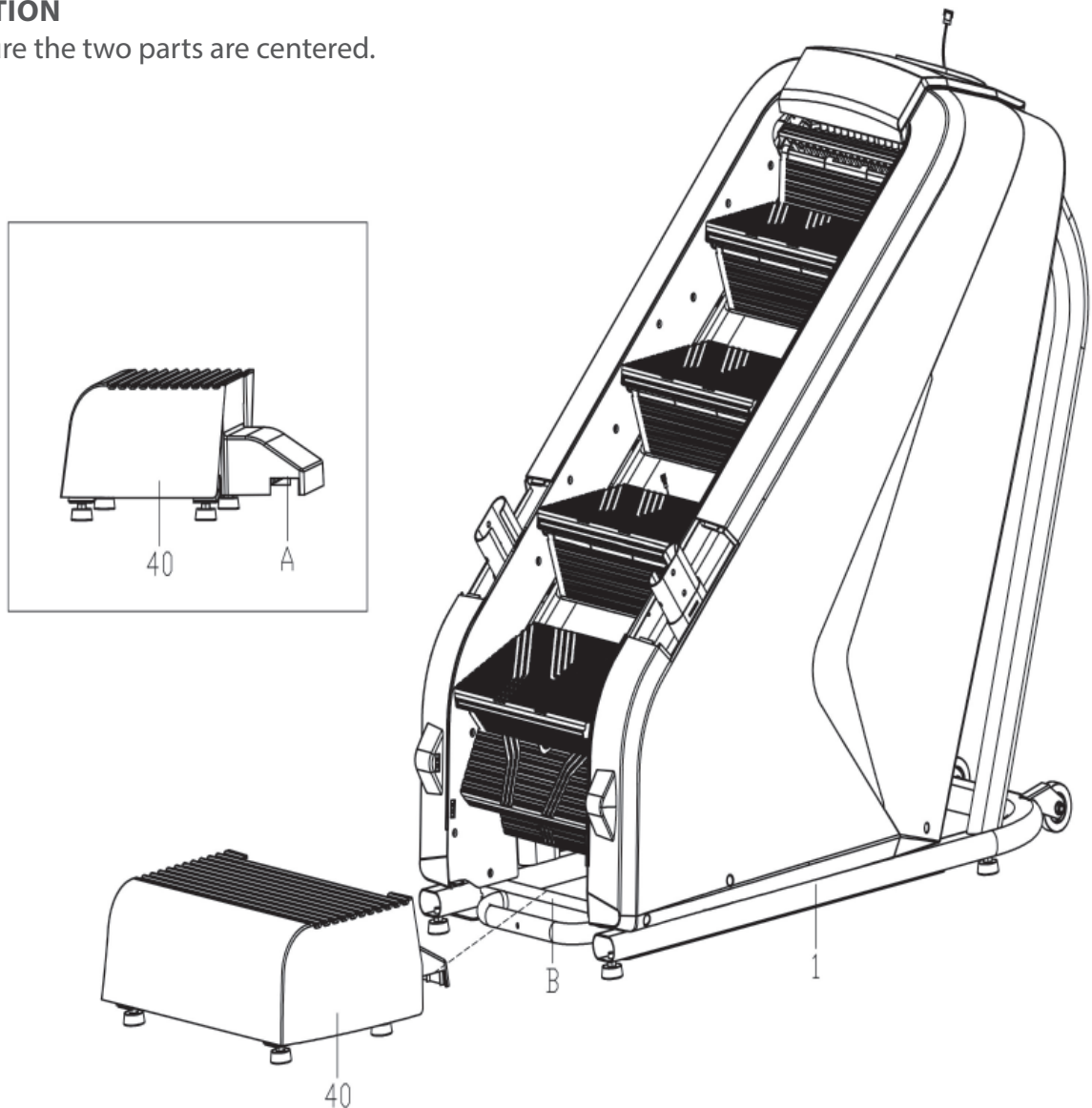

Step 2: Assembly of the Support Column and Decorative Cover

► **ATTENTION**

Make sure not to pinch the cables during the following steps.

1. Connect the console extension wire (104) to the lower wire (105).

ⓘ **NOTICE**

Do not fully tighten the screws yet in the following step.

2. Attach the support column (5) to the main frame (1) with four screws (68) and four washers (95).
3. Attach the decorative cover (58) to the support column (5) so it lays flat on the main frame (1).

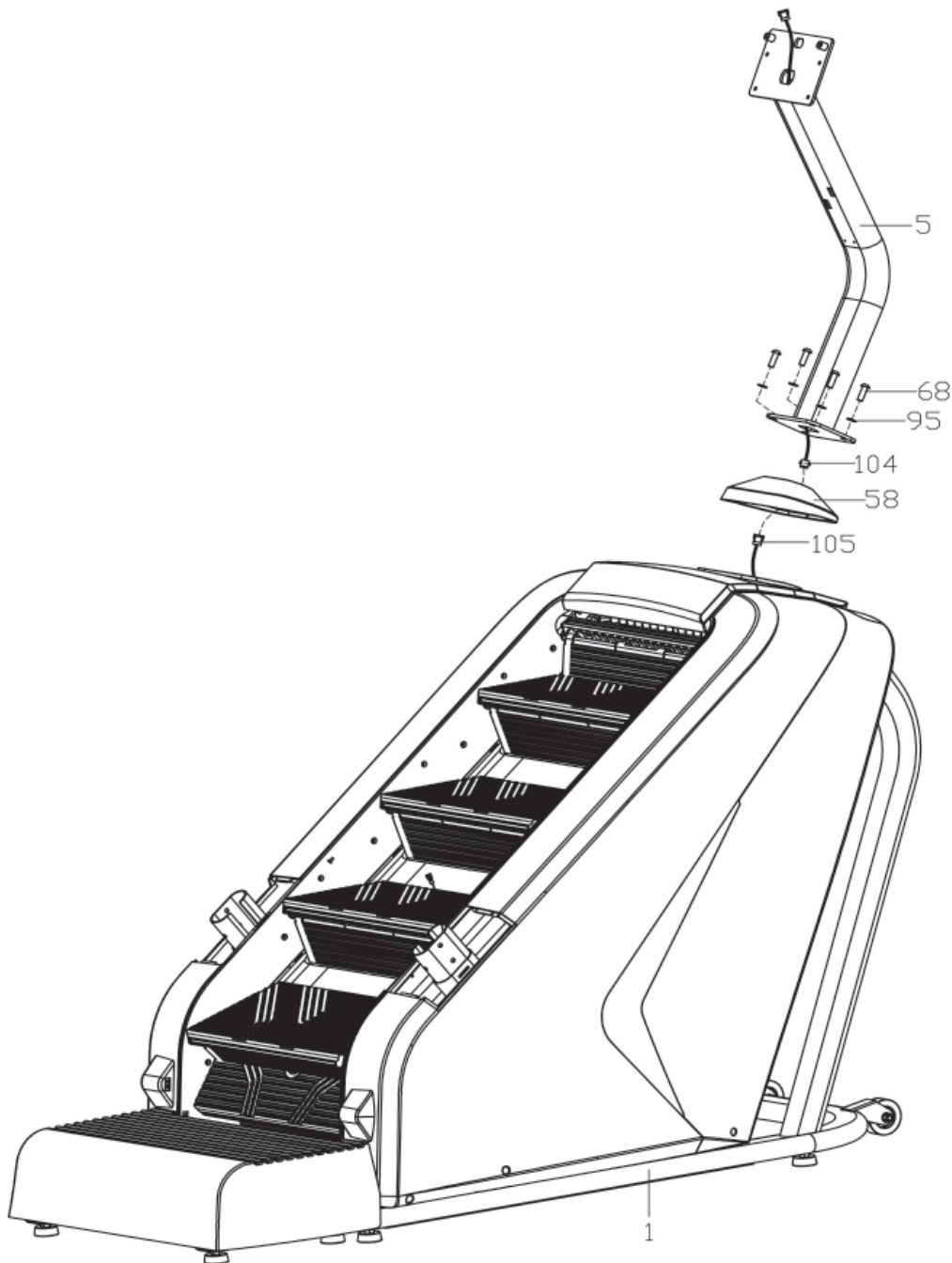

Step 3: Assembly of the Support Columns, Handrails and Decorative Covers

1. Slide the left and right decorative covers (41L & 41R) onto the left and right support columns (2L & 2R).

► **ATTENTION**

Make sure not to pinch the cables during the following steps.

2. Carefully pass the switch upper wire 1 (106) through the right decorative cover (41R).
3. Connect the switch upper wire 1 (106) to the lower wire 1 (107).

ⓘ **NOTICE**

Do not fully tighten the screws yet in the following steps.

4. Attach the left and right support columns (2L & 2R) to the main frame (1) with three screws (69) and three washers (95) each.
5. Attach the left and right handrails (3L & 3R) to the left and right support columns (2L & 2R) with two screws (73) and two washers (96) each.

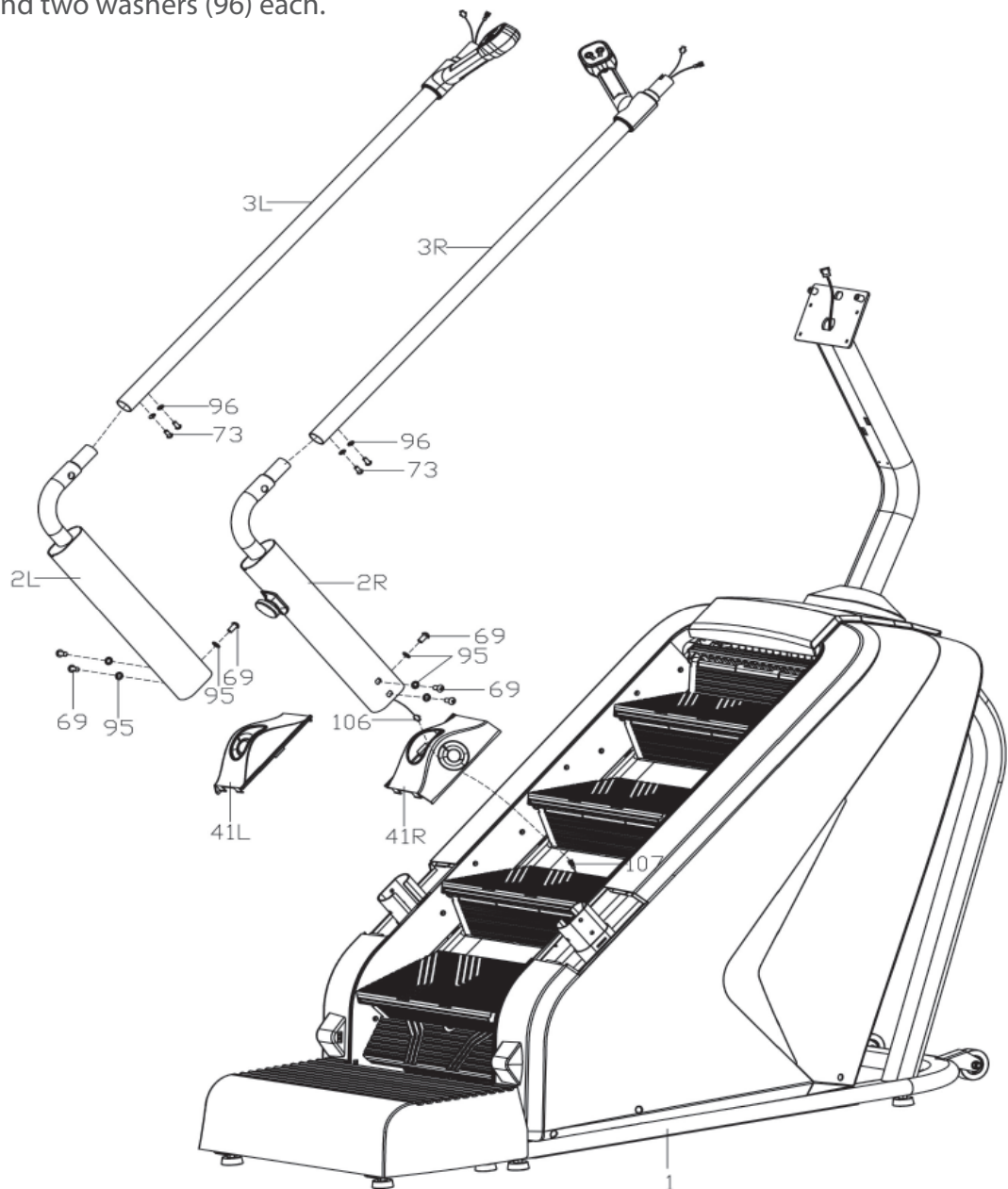

Step 4: Assembly of the Rear Handrail and Decorative Covers

1. Connect the pulse extension wire 1 (111) to the pulse extension wire 2 (112).
2. Connect the key board extension wire 1 (115) to the key board extension wire 2 (116).
3. Repeat the steps on the other side.

► **ATTENTION**

Make sure not to pinch the cables during the following steps.

4. Carefully insert the rear handrail (4) into the left and right handrails (3L & 3R).
5. Attach the rear handrail (4) to the left and right handrails (3L & 3R) with four screws (73) and four washers (96).
6. Thread the pulse extension wire 2 (112), the key board extension wire 2 (116) and the switch upper wire 2 (108) of the rear handrail (4) through the L hole of the support column (5).
7. Attach the rear handrail (4) to the support column (5) with two screws (72).
8. Fasten the left and right decorative covers (41L & 41R) to the main frame (1).
9. Attach the left exterior and interior decorative covers (44L & 45L) to the left support column (2L) with three screws (82) and one screw (79).
10. Attach the right exterior and interior decorative covers (44R & 45R) to the right support column (2R) with three screws (82) and one screw (79).
11. Now tighten all screws from this and previous steps.

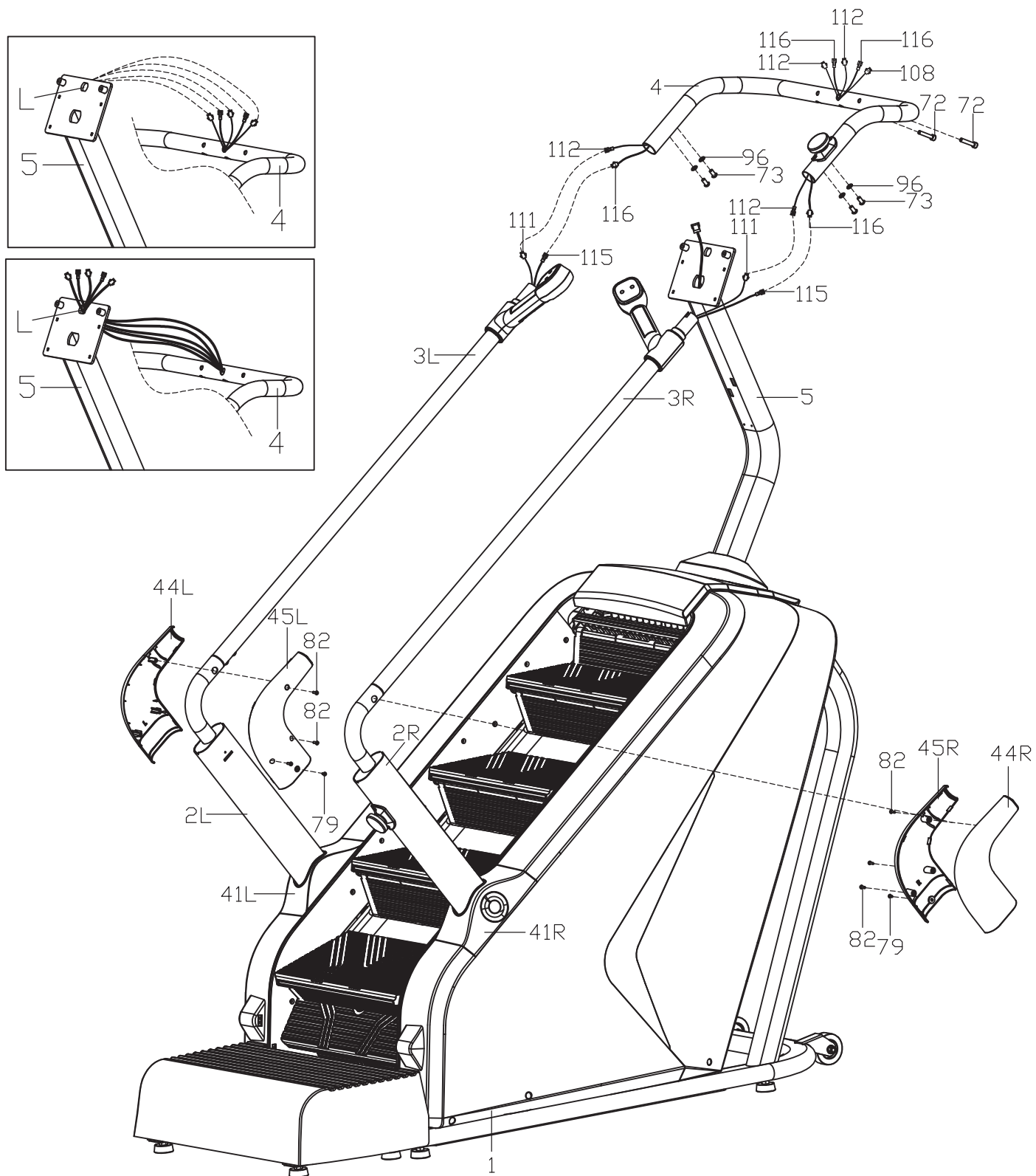

Step 5: Assembly of the Console and Bottle Holder

1. Connect the wires of the console (47) with their respective components on the rear handrail (4) and support column (5).

► **ATTENTION**

Make sure not to pinch the cables during the following steps.

2. Attach the console (47) to the support column (5) with four screws (78).
3. Attach the decorative cover (48) to the rear side of the console (47) with four screws (82).
4. Slide the bottle holder (49) onto the support column (5) and attach with two screws (78).
5. Check that all screws are properly tightened and retighten if needed.

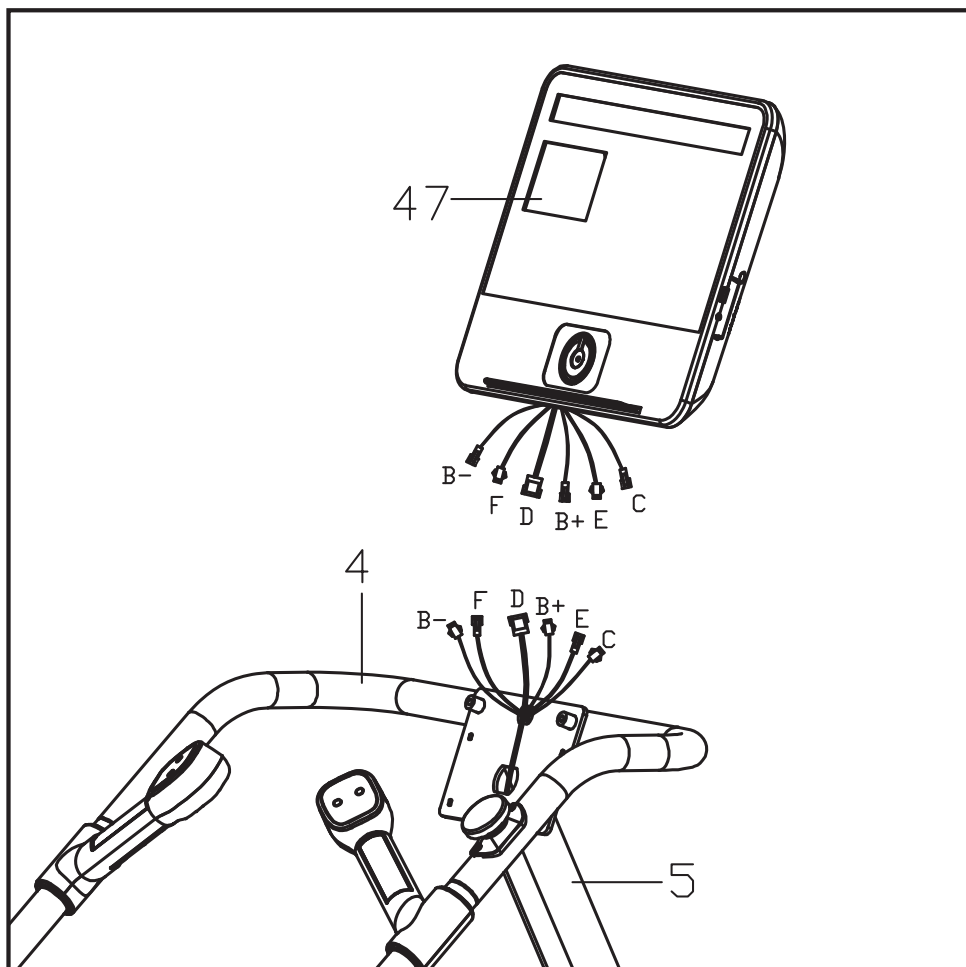

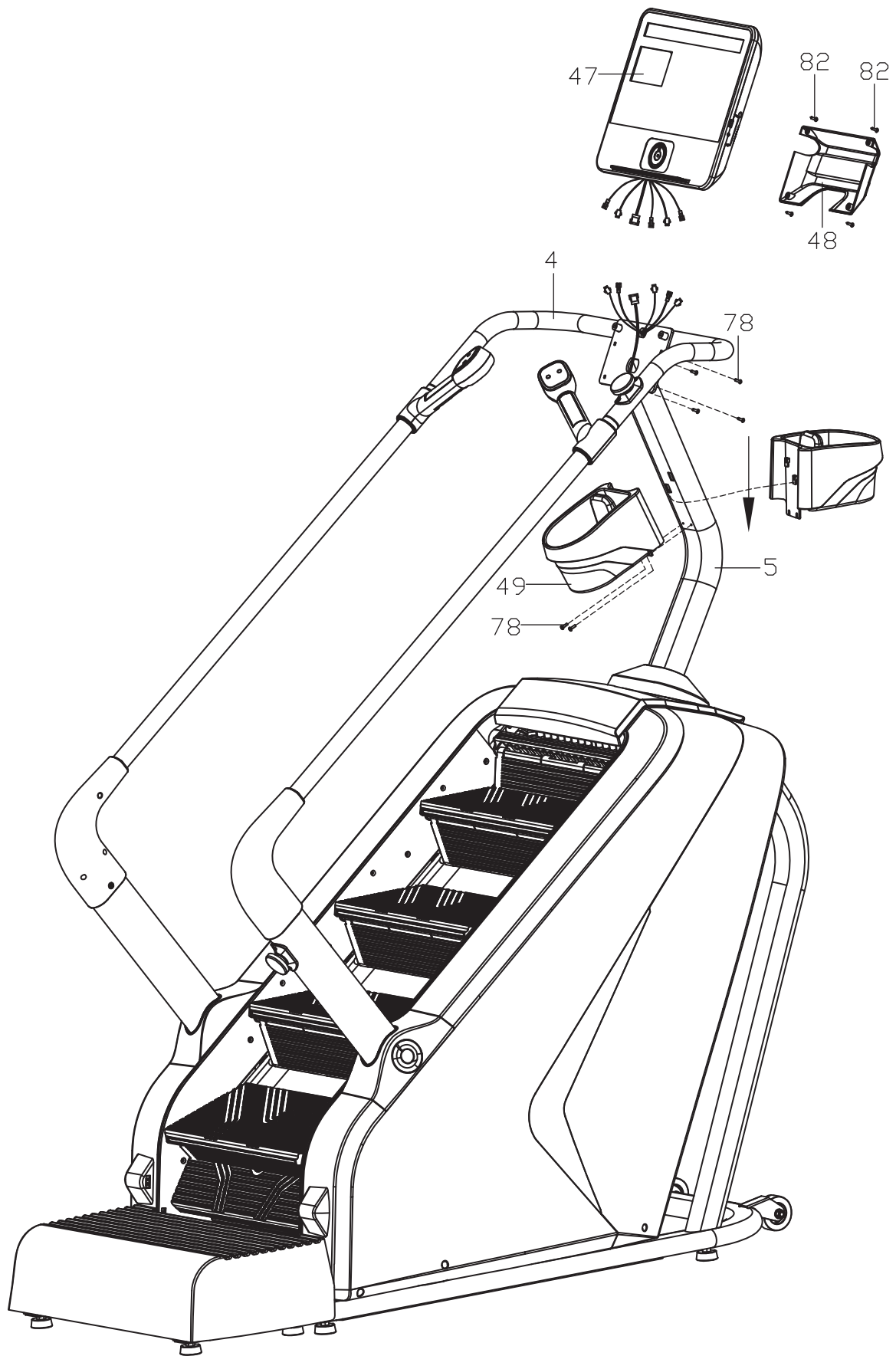

Step 6: Alignment of the Feet

If the floor is uneven, you can stabilize the stair trainer by turning the two setting screws under the main frame.

1. Lift the stair trainer on the desired side and rotate the setting screws under the main frame.
2. Rotate the screws clockwise in order to raise the surface.
3. Rotate them counterclockwise in order to lower the surface.

Step 7: Connecting the Equipment to the Mains Supply

► ATTENTION

The equipment must not be connected to a multiple socket, otherwise it cannot be guaranteed that the equipment will be supplied with sufficient power. Technical errors can result.

Plug the power plug into a wall outlet that complies with the instructions in the chapter on electrical safety.

Correctly Getting On and Off

1. To step onto the treadmill, grip the handrails with both hands and step onto the treadmill one foot at a time.
2. To get off, grip the handrails with both hands and step off the treadmill one foot at a time.

3 OPERATING INSTRUCTIONS



NOTICE

- + Familiarise yourself with all the functions and setting options of the device before starting training. Have the proper use of this product explained to you by a specialist.
- + Always start your training with low intensity and increase evenly and gently. End your training with a cool-down phase. If you are unsure, please consult your physician.
- + Please bear in mind that the noise emission under load is higher than without load.

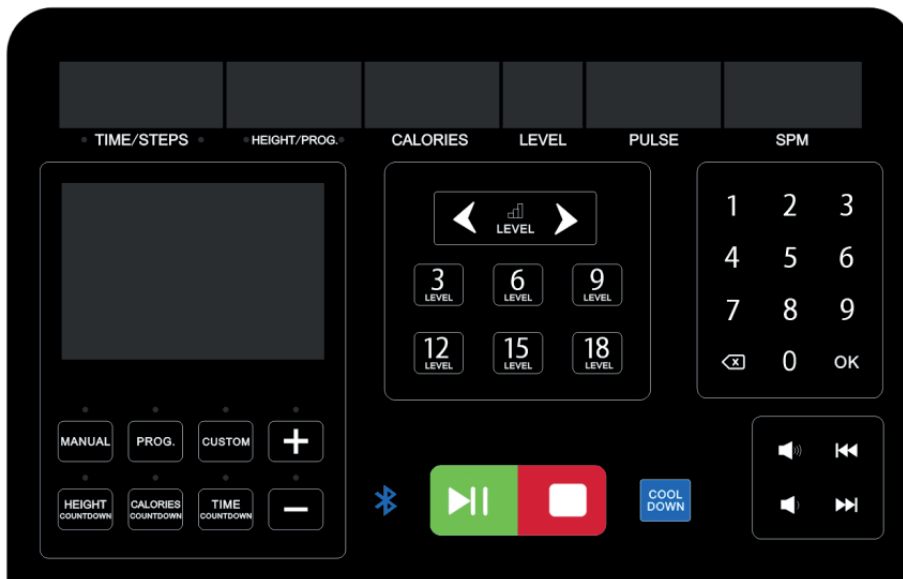
3.1 Console Display





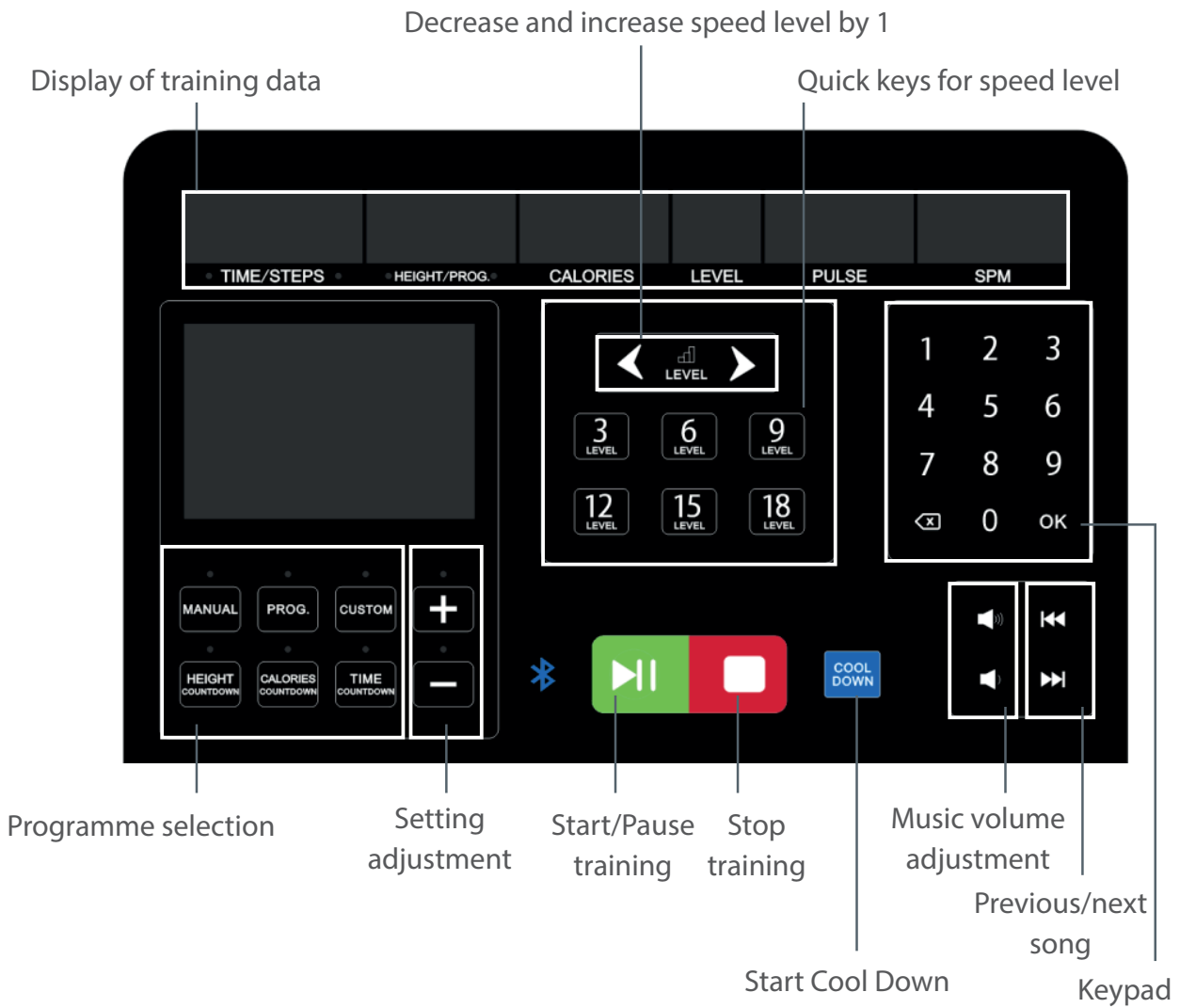

Time	<ul style="list-style-type: none"> + Display of the training time in minutes + Display range: 0:00-99:59 + Setting range: 5:00-99:59 + Default setting value: 15:00
Steps	<ul style="list-style-type: none"> + Display of the accumulated steps + Display range: 0-9999
Height	<ul style="list-style-type: none"> + Display of the accumulated height i metres + Display range: 0.0-999 m + Setting range: 5.0-999 m + Default setting value: 10.0 m
Prog.	<ul style="list-style-type: none"> + Display of the programme number in settings mode

<p>Calories</p>	<ul style="list-style-type: none"> + Display of calorie consumption in kcal + Display range: 0-999 + Setting range: 10.0-999 + Default setting value: 50.0 <p> NOTICE These data serve as a rough guide for comparing training sessions. They must not be used for medical purposes.</p>
<p>Level</p>	<ul style="list-style-type: none"> + Display of the current speed in level + Display range: 1-25 + Setting range: 1-25 + Default setting value: 1
<p>Pulse</p>	<ul style="list-style-type: none"> + Display of heart rate in beats per minute (BPM) + Display range: 50-200 <p> WARNING Your training equipment is not a medical device. The heart rate measurement of this equipment may be inaccurate. Various factors can affect the accuracy of the heart rate measurement. The heart rate measurement serves only as a training aid.</p> <p> NOTICE To display a pulse, you must grasp the hand pulse sensors or wear a compatible chest strap.</p>
<p>SPM</p>	<ul style="list-style-type: none"> + Display of the current pace in steps per minute (SPM) + Display range: 0-999



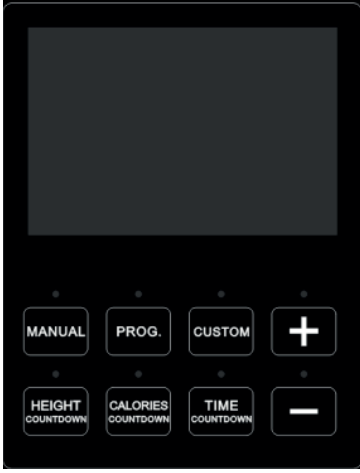

3.2 Button Functions

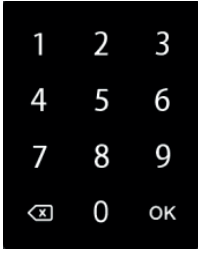

	START/PAUSE	+ Press to start and pause training
	STOP	+ Press to stop training
	+ / -	+ Press + to increase setting value by 1 + Press - to decrease setting value by 1 + Press and hold for fast increase/decrease
	VOLUME (+)	+ Press to increase music volume
	VOLUME (-)	+ Press to decrease music volume

	PREVIOUS SONG	<ul style="list-style-type: none"> + Press to skip to the previous song
	NEXT SONG	<ul style="list-style-type: none"> + Press to skip to the next song
	COOL DOWN	<ul style="list-style-type: none"> + Press during training to start cool down + A countdown of 30 or 45 seconds starts + When speed is set between 1 and 15, the machine stops within 30 seconds + When speed is set between 16 and 25, the machine stops within 45 seconds
 <p>PROGRAMME SELECTION</p>		<ul style="list-style-type: none"> + Select between programmes: Manual, Prog., Custom, Height Countdown, Calories Countdown, Time Countdown + Press on respective button to select a programme + Press + to increase setting value + Press - to decrease setting value
 <p>LEVEL ADJUSTMENT</p>		<ul style="list-style-type: none"> + Speed level adjustment + Press on the arrows to increase/decrease speed level by 1 + Press on the quick keys (3, 6, 9, 12, 15, 18) to adjust the speed to the according level (e.g. if you press 9, it will automatically set level 9) + For safety reasons, a speed level of maximum 18 can be selected via the quick keys. For levels above and up to 25, you must use the keypad or the arrows on the screen or on the handles.
 <p>KEYPAD</p>		<ul style="list-style-type: none"> + Speed and setting adjustment + Press keys to quickly set settings + Press "X" to clear settings + Press "OK" to confirm settings

Four buttons for the most important functions have been integrated on the handles for easier operation during training. The buttons for “start/pause” and “stop” are located on the left handle. The buttons for speed increase and decrease are located on the right handle. The machine is also equipped with two red emergency stop switches that are located near the right handle and on the right support column at the bottom of the machine.

	<p>START/PAUSE</p>	<ul style="list-style-type: none"> + Press to start training + Press to pause training
	<p>STOP</p>	<ul style="list-style-type: none"> + Press to stop training
	<p>SPEED (UP)</p>	<ul style="list-style-type: none"> + Press to increase the speed + Each press increases the speed by 1 level + Setting range: 1-25
	<p>SPEED (DOWN)</p>	<ul style="list-style-type: none"> + Press to decrease the speed + Each press decreases the speed by 1 level + Setting range: 1-25
	<p>EMERGENCY STOP SWITCH</p>	<ul style="list-style-type: none"> + Turn clockwise to unlock the equipment + Press down to lock the equipment + Press down for emergency stop

NOTICE

Please note that not all smartphones are compatible for wireless charging.

Wireless charging function for smartphones

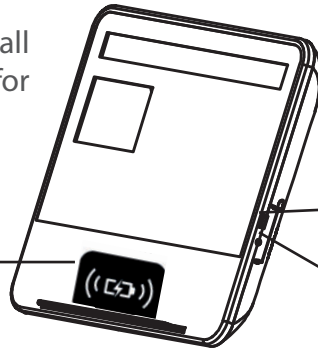

USB

USB port to read audio and video data



Audio output for headphones



Emergency stop switch

Infrared sensing area

Emergency stop switch

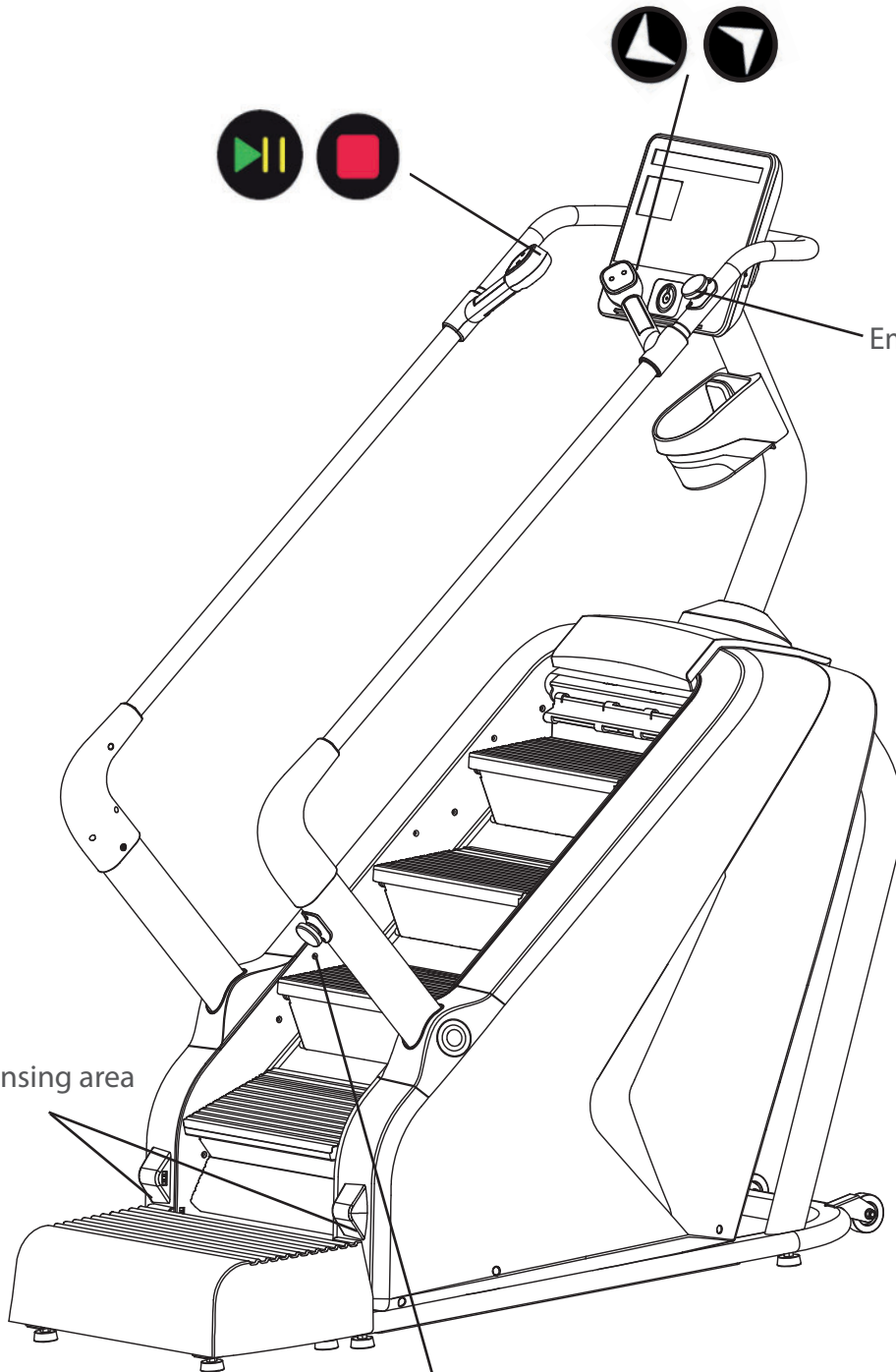

3.3 Turning On the Equipment and Initial Settings

1. Insert the power plug into a wall outlet.
2. Turn on the power switch.
3. Unscrew the two emergency stop switches.
4. Check that the infrared sensing area is free of obstructions.



WARNING

The infrared sensing area must always be free of obstructions when you stand on the equipment.

Infrared Sensing Area

If any object enters the infrared sensing area during operation, the machine will immediately stop, an error message occurs in the display and an alarm sounds. Once the object is removed, the alarm automatically stops. Press the stop button to clear the error message, then press the start button to resume the workout.

3.4 Training Programmes

The console offers a wide variety of different training options and programmes. These include a quick start function for immediate training, countdown programmes, pre-set programmes and user defined programmes.

3.4.1 Quick Start (MANUAL)

The quick start function is the ideal choice if you want to start your training immediately and without setting any specific training data. A workout with a constant speed level begins. The speed does not change automatically, but can be set and adjusted individually.

1. To start the quick start function, press Start in standby mode. Alternatively you can press the respective button (manual).

A countdown 3-2-1 begins.

The steps start moving and the workout begins at speed level 1.

All values count upwards.

2. To adjust the speed, press the speed buttons and confirm with OK or use the quick keys.
3. To pause the workout, press Pause.

The machine slows down to a stop.

4. To continue the workout, press Start.

A countdown 3-2-1 begins before the machine starts moving. For safety reasons, the machine starts at the lowest speed level before automatically returning to the set speed level before the workout was paused.

5. To end the workout, press Stop.

The machine slows down to a stop.

3.4.2 Countdown Programmes (HEIGHT, CALORIES, TIME)

There are three so-called target or countdown programmes in which you can set a target value for either height, calories or time. The programme will start a countdown from the set target value and ends automatically when you have reached your goal.

1. To select your programme, press on the respective button (height, calories or time countdown) and confirm with OK.

The default setting value blinks.

2. Set the desired target value and confirm with OK.
3. To start the workout, press Start.

A countdown 3-2-1 begins.

The steps start moving and the workout starts. The set target value will count down to zero whilst the remaining training data will count up from zero.

4. To adjust the speed, press the speed buttons and confirm with OK or use the quick keys.
5. To pause the workout, press Pause.

The machine slows down to a stop.

6. To continue the workout, press Start.

A countdown 3-2-1 begins before the machine starts moving. For safety reasons, the machine starts at the lowest speed level before automatically returning to the set speed level before the workout was paused.

7. To end the workout before the set target value is reached, press Stop.

The machine slows down to a stop.

3.4.3 Pre-set Programmes (PROG.)

There are 36 pre-set programmes (P01 - P36) to choose from. Contrary to the quick start function, these programmes have pre-set speed levels that vary within the set training time. Each programme consists of 20 segments. The duration of each segment depends on the training time. To calculate the duration of each segment, the training time must be divided by 20. It is not possible to manually switch to the next segment. The programme automatically ends when the training time has elapsed.

1. To select the pre-set programmes, press Prog. and confirm with OK.
2. Continuously press Prog. until you have reached the desired programme (P01 - P36).
3. Confirm the selected programme with OK.
4. Set the desired training time and confirm with OK.
5. To start the workout, press Start.

A countdown 3-2-1 begins.

The steps start moving and the workout starts. The set training time will count down to zero whilst the remaining training data will count up from zero.

ⓘ NOTICE

If you adjust the speed level, it will only be applied to the current segment.

6. To adjust the speed for the current segment, press the speed buttons and confirm with OK or use the quick keys.
7. To pause the workout, press Pause.

The machine slows down to a stop.

8. To continue the workout, press Start.

A countdown 3-2-1 begins before the machine starts moving. For safety reasons, the machine starts at the lowest speed level before automatically returning to the set speed level before the workout was paused.

9. To end the workout before the set training time has elapsed, press Stop.

The machine slows down to a stop.

The drawing below shows the profiles of each of the pre-set programmes. With this drawing you can see which speed level is pre-set for each of the 20 segments within the 36 pre-set programmes.

P1 - P36: Pre-Set programmes

S1 - S20: Segment 1 to 20

	S1	S2	S3	S4	S5	S6	S7	S8	S9	S10	S11	S12	S13	S14	S15	S16	S17	S18	S19	S20
P1	4	5	5	6	6	7	7	7	7	7	7	7	7	7	7	6	6	5	5	1
P2	4	5	5	6	7	7	10	7	10	10	10	7	10	10	7	7	6	5	5	1
P3	4	5	5	6	7	7	10	10	7	10	10	10	10	7	7	7	6	5	5	1
P4	4	5	5	6	6	9	9	9	9	9	9	12	9	9	9	6	6	5	5	1
P5	4	5	5	6	7	9	9	9	9	12	9	9	9	9	9	7	6	5	5	1
P6	4	5	5	7	7	9	9	12	12	12	12	9	9	9	9	9	7	5	5	1
P7	4	5	6	8	8	11	11	11	11	11	11	11	11	11	11	11	8	6	6	2
P8	4	5	5	7	7	10	10	10	10	12	12	12	12	12	12	12	12	12	11	4
P9	4	5	5	8	8	11	11	11	9	11	11	11	11	11	11	11	8	5	5	2
P10	4	5	5	7	7	9	5	7	7	9	5	7	7	9	5	7	7	9	7	3
P11	4	6	6	8	8	11	6	8	8	11	6	8	8	11	6	8	8	11	6	1
P12	4	6	6	9	12	12	6	9	12	12	6	9	12	12	6	9	12	12	9	4
P13	4	9	4	9	4	9	4	9	4	9	4	9	4	9	4	9	4	9	4	9
P14	4	5	5	8	11	11	5	8	11	11	5	8	11	11	5	8	11	11	8	3
P15	4	6	9	9	9	6	9	9	9	6	9	9	9	6	9	9	9	6	4	2
P16	4	6	6	11	6	11	6	11	6	11	6	11	6	11	6	11	6	11	6	9
P17	4	4	4	6	8	8	11	11	11	4	6	8	8	11	11	11	8	4	4	2
P18	5	8	5	8	8	5	8	8	5	8	8	5	8	8	5	8	8	4	4	2
P19	4	9	4	9	4	9	4	9	4	9	4	9	4	9	4	9	4	9	4	2
P20	4	12	4	12	4	12	4	12	4	12	4	12	4	12	4	12	4	12	4	4
P21	4	8	4	8	11	4	8	11	4	8	11	4	8	11	4	8	11	4	8	2
P22	6	8	11	8	4	11	8	4	11	8	4	11	8	4	11	8	4	4	6	2
P23	6	8	11	8	8	4	11	8	8	4	11	8	8	4	11	8	8	4	4	2
P24	6	8	11	8	6	11	8	6	11	8	6	11	8	6	11	8	6	4	6	2
P25	4	6	5	6	5	7	6	4	7	4	8	4	9	4	10	5	9	5	11	3
P26	4	7	6	8	6	8	6	4	6	5	5	8	7	9	7	9	7	5	7	2
P27	4	7	6	7	6	7	6	4	5	5	5	8	7	8	7	8	7	5	6	2
P28	4	8	9	6	6	9	6	4	6	5	5	9	10	7	7	10	7	5	7	2
P29	4	6	8	10	9	10	8	4	5	5	5	7	9	11	10	11	9	5	6	2
P30	4	6	7	7	8	7	8	5	5	5	5	7	8	8	9	8	9	6	6	2
P31	5	8	9	7	10	7	11	8	6	4	6	9	10	8	11	8	11	9	6	3
P32	4	7	8	6	9	7	8	7	5	5	5	8	9	7	10	8	9	8	6	3
P33	4	10	8	6	7	11	9	7	6	6	5	11	9	7	8	11	10	8	7	3
P34	4	5	7	5	5	7	5	8	5	6	5	6	8	6	6	8	6	9	6	3
P35	4	7	10	11	8	11	7	5	4	5	5	8	11	11	9	11	8	6	5	2
P36	4	7	7	6	6	8	6	4	5	7	5	8	8	7	7	9	7	5	6	4

3.4.4 User-defined Programmes (CUSTOM)

The user-defined programmes allow users to customize their own profile programme. The concept is similar to the pre-set programmes, except that users can individually define the speed level from 1 to 25 for each segment in the programme. There are a total of three customizable programmes (U01-U03).

1. To select the user-defined programmes, press Custom and confirm with OK.
2. Continuously press Custom until you have reached the desired programme (U01-U03).
3. Confirm the programme with OK.
4. Set the desired speed level of each segment and confirm each entry with OK.
5. Repeat setting and confirming until all 20 segments are set.
6. Set the training time.
7. To start the workout, press Start.

A countdown 3-2-1 begins.

The steps start moving and the workout starts. The set training time will count down to zero whilst the remaining training data will count up from zero.

① NOTICE

If you adjust the speed level, it will only be applied to the current segment.

8. To adjust the speed for the current segment, press the speed buttons and confirm with OK or use the quick keys.
9. To pause the workout, press Pause.

The machine slows down to a stop.

10. To continue the workout, press Start.

A countdown 3-2-1 begins before the machine starts moving. For safety reasons, the machine starts at the lowest speed level before automatically returning to the set speed level before the workout was paused.

11. To end the workout before the set training time has elapsed, press Stop.

The machine slows down to a stop.

3.5 Body Mass Index (FAT)

The console is equipped with an in-built Body Mass Index (in short: BMI) calculator. BMI can be used to measure a person's height and weight in relation to one another.

 **WARNING**

- + This data is for reference only and must not be considered as medical data.
- + The BMI calculation does not distinguish between fat or muscle mass.

1. In standby, continuously press Prog. until "FAT" is displayed.
2. To select the BMI function (FAT), press OK.
3. Set each parameter F-1 (gender: 01 male, 02 female), F-2 (age), F-3 (height) and F-4 (weight) and confirm each parameter with OK.

The console enters F-5.

4. Grasp the hand pulse sensors with both hands for at least 2-3 seconds.

Your Body Mass Index is displayed.

F-1	Gender	01 (male)	02 (female)
F-2	Age	10-----99	
F-3	Height	100-200 (cm)	
F-4	Weight	20-150 (kg)	
F-5	FAT	≤ 19	Underweight
	FAT	$=(20---25)$	Normal weight
	FAT	$=(26---29)$	Overweight
	FAT	≥ 30	Obesity

3.6 Bluetooth

The console is equipped with a Bluetooth interface that allows you to connect your smartphone in order to play music.

The Bluetooth name of the console is SYMK.

1. Make sure Bluetooth is activated on your smartphone.
2. Search for the Bluetooth device "SYMK" in the Bluetooth settings of your smartphone.
3. Tap on "SYMK" to connect the smartphone to the console.

If the connection is successful, the console beeps briefly.

4.1 General Instructions

WARNING

- + The storage location should be chosen so that improper use by third parties or children can be prevented.
- + If your equipment does not have transportation wheels, the equipment must be disassembled before transportation.

▶ ATTENTION

- + Make sure that the equipment is protected from moisture, dust and dirt in the selected storage location. The storage location should be dry and well ventilated and have a constant ambient temperature between 10°C and 35°C.

4.2 Transportation Wheels

▶ ATTENTION

If you want to transport your equipment over particularly sensitive and soft floor coverings, such as parquet, planks or laminate, lay out the transport route with cardboard or similar to avoid possible floor damage.

1. Stand behind the equipment and lift it until the weight is transferred to the transportation wheels. After that, you easily can move the equipment to a new position. For long transport distances the equipment should be disassembled and safely packed.
2. Select the new location by following the instructions in the section 1.4 of this manual.

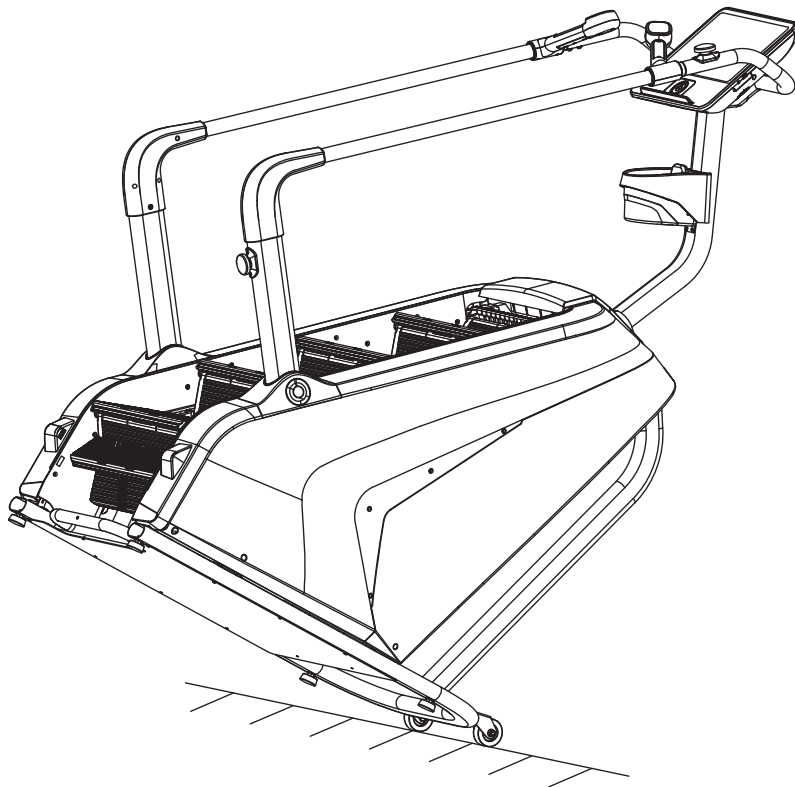

5.1 General Instructions



WARNING

- + Do not make any improper changes to the equipment.



CAUTION

- + Damaged or worn components may affect your safety and the life of the equipment. Therefore, immediately replace damaged or worn components. In such a case, contact the contract partner. The equipment must not be used until it has been repaired. If necessary, use only original spare parts.

► ATTENTION

- + In addition to the instructions and recommendations for maintenance and care given here, additional service and/or repair work may be necessary; this must only be carried out by authorised service technicians.

5.2 Faults and Fault Diagnosis

The equipment undergoes regular quality controls during production. Nevertheless, faults or malfunctions may occur. Frequently, individual parts are responsible for these disturbances, an exchange is usually sufficient. Please refer to the following overview for the most common errors and how to correct them. If the equipment still does not function properly, contact your contract partner.

Fault	Cause	Solution
Display is blank/not working	<ul style="list-style-type: none"> + Interrupted power connection + Loose cable connections 	<ul style="list-style-type: none"> + Power switch to on + Check cable connections
Equipment wobbles	Equipment is not level	Align the feet
No pulse display	<ul style="list-style-type: none"> + Sources of interference in the room + unsuitable chest strap + Wrong position of chest strap + Chest strap defective or battery empty + Pulse display defective 	<ul style="list-style-type: none"> + Eliminate sources of interference (e.g. mobile phone, WLAN, lawn mower and vacuum cleaner robot, etc. ...) + Use a suitable chest strap (see RECOMMENDED ACCESSORIES). + Reposition chest strap and/or moisten electrodes + Changing batteries + Check if pulse display by hand pulse possible

5.3 Error Codes and Troubleshooting

The electronics of the equipment continuously carries out tests. In case of deviations, an error code appears on the display and normal operation is stopped for your safety.

- + E80: Communication failure
- + E02: Communication failure
- + E08: Lower control infrared failure
- + E48: No speed sensing signal

Please contact the contract partner for technical support.

5.4 Maintenance and Inspection Calendar

To avoid damage from body sweat, the equipment must be cleaned with a damp towel (no solvents!) after each training session.

The following routine tasks must be performed at the specified intervals:

Part	Weekly	Monthly	Quarterly
Display console	C	I	
Steps	C	I	
Frame	C	I	I
Covers and hand rails	C	I	
Screws and cable connections			I
Lubricate chains*			C/I
Legend: C = clean; I = inspect			

*Clean and lightly lubricate with silicone spray or silicone oil on a lint-free cloth.



WARNING

Always unplug the power cord before performing the maintenance steps.

6 DISPOSAL

At the end of its operational life, this equipment cannot be disposed of in normal household waste. Instead, it must be disposed of via an electricals recycling centre. Further information can be obtained from your local authority's recycling service.



The materials can be recycled as per their symbols. Through the reuse, recycling of materials or other forms of recovery of old equipment, you make an important contribution to the protection of the environment.

7 RECOMMENDED ACCESSORIES

To make your training experience even more efficient and pleasant, we recommend that you add suiting accessories to your fitness equipment. For stair trainers this could for example be a **floor mat**, which makes your fitness equipment stand more securely and also protects the floor from sweat or **silicone spray** to keep moving parts in good shape and lubricate the chains.

If you have purchased a fitness machine with pulse training and want to train your heart rate, we strongly recommend that you use a compatible **chest strap**, as this ensures optimum transmission of the heart rate.

Our range of accessories offers the highest quality and makes training even better. If you would like to find out more about compatible accessories, please go to the detail page of the product in our webshop (the easiest way is to enter the article number in the search field above) and go to the recommended accessories on this page. Of course, you can also contact our customer service: by telephone, e-mail, in one of our branches or via our social media channels. We will be happy to advise you!



chest strap



floor mat



silicone spray



chest strap contact gel

8.1 Serial Number and Model Name

In order to provide you with the best possible service, please have the model name, article number, serial number, exploded drawing and parts list ready. The corresponding contact options can be found in chapter 10 of this operating manual.

NOTICE

The serial number of your equipment is unique. It's located on a white sticker. The exact position of this sticker is shown in the following illustration.

Enter the serial number in the appropriate field.

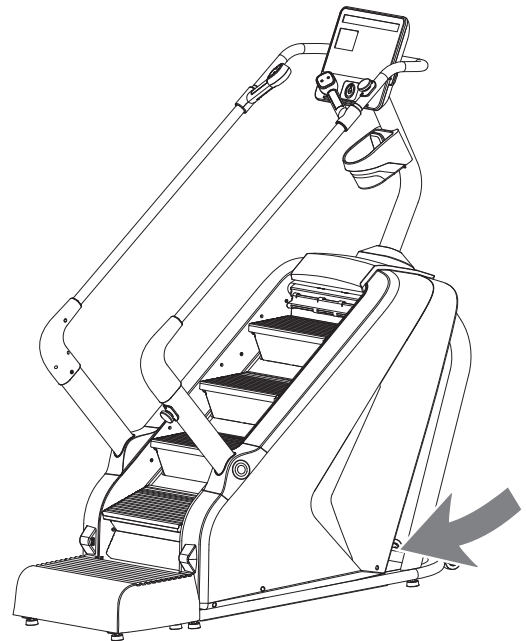

Serial number:

Brand / Category:

Taurus / stair trainer

Model Name:

Stair Trainer ST10.5

Article Number:

TF-ST105

8.2 Parts List

No.	Name	Qty.	No.	Name	Qty.
1	Main frame	1	32	KP005 pedestal bearing	2
2L/R	Support columns	1 p.r.	33	brake combination	1
3L/R	Handrails	1p.r.	34L/R	Protective cover	1p.r
4	Rear handrail	1	35L/R	Inner protective cover	1p.r
5	Console support column	1	36L/R	Decorative strips	1p.r
6	Rear pedal	1	37	Upper protective cover	1
7	Front roller	1	38	Upper protective cover 2	1
8	Rear gear	2	39	Rear cover	1
9	Sensor fix tube	1	40	Pedal	1
10	Light sensor support	1	41L/R	Decorative cover	1p.r
11	PCB baffle	1	42L/R	Upper cover	1p.r
12	Fixing plug	6	43L/R	Lower cover	1p.r
13	Stair support 1	8	44L/R	Exterior decorative cover	1p.r
14	Stair support 2	8	45L/R	Interior decorative cover	1p.r
15	Infrared shield	2	46	Wireless charge module	1
16	Cover fixing	4	47	Console	1
17	Pulley shaft sleeve	1	48	Rear decorative cover	1
18	Emergency stop disk sleeve	1	49	Bottle Holder	1
19	Rear roller shaft	1	50	Emergency stop switch	2
20	Guide	2	51	Switch base 1	1
21	Guide2	2	52	Switch base 2	1
22	Support sleeve 1	8	53	Step spacer 1	16
23	Support sleeve 2	2	54	Step spacer 2	16
24	Bearing connecting shaft	16	55	Wear washer	40
25	Step connecting shaft	8	56	Pedal 1	8
26	Chain	2	57	Pedal 2	8
27	Emergency stop plate	1	58	Decorative cover	1
28	Belt pulley	1	59	Bottom baffle	1
29	Foot pad	8	60	Middle baffle	1
30	Bearing 608Z	32	61	Belt	1
31	Bearing 6004	4	62	Anti slip pad	1

63	EVA silencing pad	16	93	Outer snap ring Φ 8	32
64	Roller	2	94	E-type snap ring Φ 7	24
65	Allen bolt M10 * 40	4	95	Internal serrated washer Φ 10*1.2	12
66	Allen bolt M10 * 170	2			
67	Outer hexagon bolt M10 * 45	2	96	Internal serrated washer Φ 8*1.2	8
68	Allen bolt M10 * 30	4	97	Standard spring washer Φ 10	4
69	Allen bolt M10 * 20	6	98	standard flat washer Φ 10	4
70	Allen bolt M8 * 105	10	99	Flat washer Φ 8	32
71	Allen bolt M8 * 75	3	100	Flat washer Φ 6	4
72	Allen bolt M8 * 40	2	101	Controller	1
73	Large flat head bolt M8 * 15	8	102	Power cord	1
74	Flat end tightening M4 * 5	3	103	Console upper wire	1
75	Allen bolt M6 * 25	4	104	Console extension wire	1
76	Flat end tightening M5 * 10	3	105	Console lower wire	1
77	Phillips screw w/cushion head ST4 *12	16	106	Switch upper wire 1	1
78	Phillips screw w/ washer head M4 * 15	24	107	Switch lower wire 1	1
79	Phillips screw w/ washer head M4 * 8	2	108	Switch upper wire 2	1
80	Phillips screw w/countersunk head M4*10	9	109	Switch lower wire 2	1
81	Phillips screw ST4 0*16	2	110	Pulse upper wire	2
82	Phillips screw ST4 0*16	90	111	Pulse extension wire 1	2
83	Phillips screw ST4 0*10	36	112	Pulse extension wire 2	2
84	Phillips screw M3 * 20	2	113	Pulse lower wire	2
85	Phillips screw m3 * 15	4	114	Key board Upper wire	2
86	Phillips screw ST2 9*9.5	23	115	Key board extension wire 1	2
87	Phillips screw ST2 2*8	8	116	Key board extension wire 2	2
88	Nylon nut M10	2	117	Key board lower wire	2
89	Nylon nut M8	10	118	Infrared sensor	2
90	Nut M8	11	119	Distance sensor	1
91	Nylon NUT M6	4	120	Light sensor	1
92	Outer snap ring Φ 20	4	121	Speaker	2
			122	USB / headset interface	1
			123	Hole plug	2

8.3 Exploded Drawing

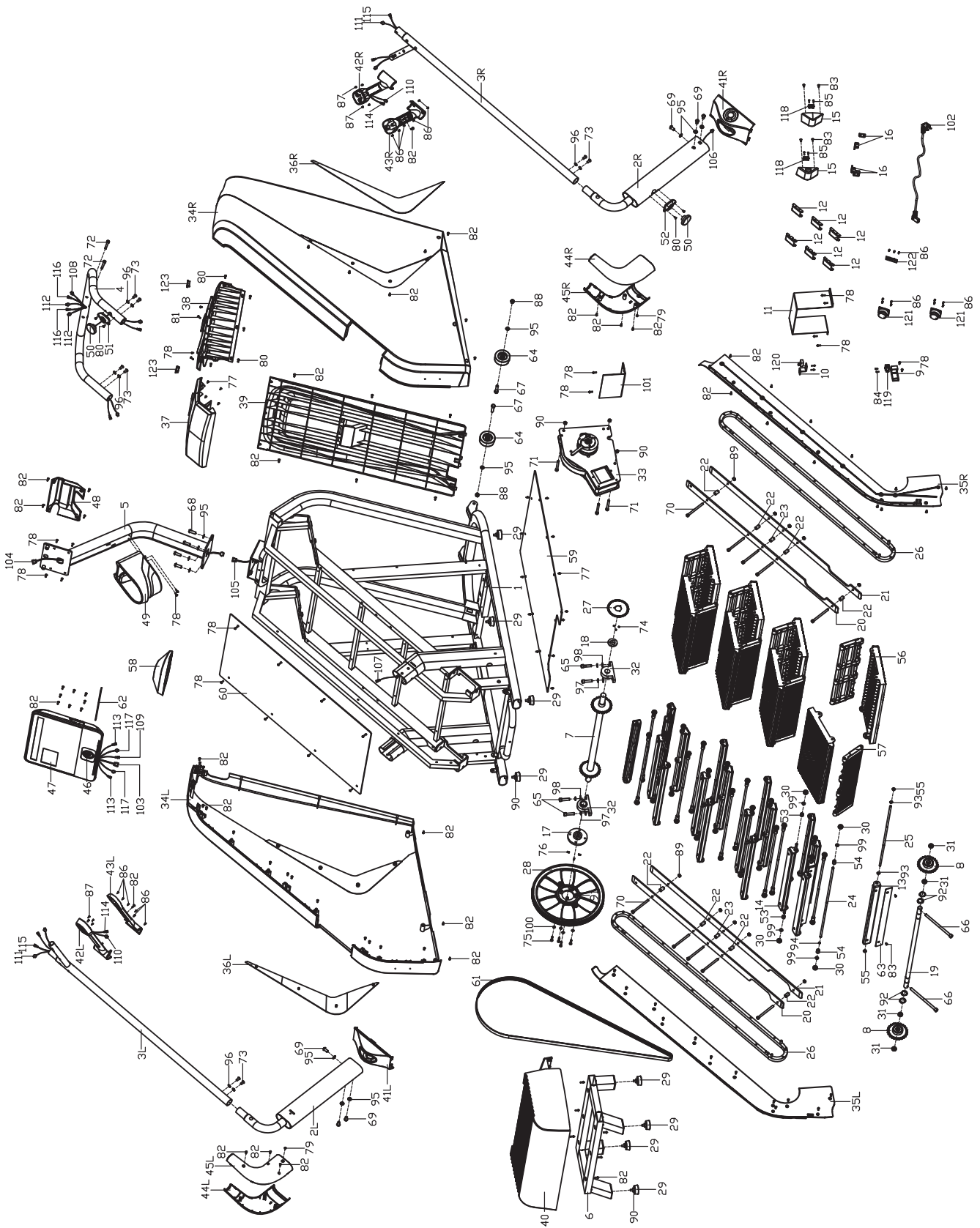

Products from TAURUS® are subject to strict quality control. However, if a fitness equipment purchased from us does not work perfectly, we take it very seriously and ask you to contact our customer service as indicated. We are happy to help you by phone via our service hotline.

Error Descriptions

Your fitness equipment is developed for long-term, high-quality training. However, should a problem arise, please first read the operating instructions. For further assistance, please contact your contract partner or call our service hotline. To ensure your problem is solved as quickly as possible, please describe the defect as exactly as possible.

In addition to the statutory warranty, we provide a warranty for every fitness equipment purchased from us according to the following provisions.

Your statutory rights are not affected.

Warrantee

The warrantee is the first/original buyer and/or any person who received a newly purchased product as a gift from the original buyer.

Warranty period

The warranty periods, shown on our web shop, begin on delivery of the fitness equipment. The respective warranty periods for your equipment can be found on its product website.

Repair Costs

According to our choice, there will either be a repair, a replacement of individual damaged parts or a complete replacement. Spare parts, that have to be mounted while assembling the equipment, have to be replaced by the warrantee personally and are not a part of repair. After the expiration of the warranty period, the responsibility for parts costs, repair costs, installation costs and delivery costs lies with the warranty holder.

The terms of use are defined as follows:

- + Home use: solely for private use in private households up to 3 hours per day
- + Semi-professional use: up to 6 hours per day (e. g. rehabilitation centres, hotels, clubs, company gyms)
- + Professional use: more than 6 hours per day (e. g. commercial gyms)

Warranty Service

Within the warranty period, equipment which develops faults as a result of material or manufacturing defects, will be repaired or replaced at our discretion. Ownership of equipment or parts of equipment which have been replaced is transferred to us. The warranty period is not extended nor does a new warranty period begin following repair or replacement under the warranty.

Warranty Conditions

For the warranty to be valid, the following steps must be taken:

Please contact our customer service by email or phone. If the product under warranty has to be sent in for repair, the seller bears costs. After expiry of the warranty, the buyer bears the costs of transport and insurance. If the fault is covered by our warranty, you will receive a new or repaired equipment in return.

Warranty claims are invalid in case of damage resulting from:

- + misuse or improper handling
- + environmental influences (moisture, heat, electrical surge, dust, etc.)
- + failure to follow the current safety measures for the equipment
- + failure to follow the operating instructions
- + use of force (e. g. hitting, kicking, falling)
- + interventions which were not carried out by one of our authorized service centres
- + unauthorised repair attempts

Proof of Purchase and Serial Number

Please make sure that you are able to provide the appropriate receipt when claiming on your warranty. So that we can clearly identify the model of your equipment, and for the purposes of our quality control, you will need to give the serial number of your equipment, when contacting the service team. Where possible please have your serial number and your customer number ready when you call our service hotline. It will help us to deal with your request swiftly.







































If you cannot find the serial number on your fitness equipment, our service team is at your disposal to offer further information.

Service outside of the Warranty Period

We are also happy to issue an individual cost estimate if there is a problem with your fitness equipment after the warranty has expired, or in cases which do not fall under the terms of the warranty, e. g. normal wear and tear. Please contact our customer service team to find a quick and cost-effective solution to your problem. In such a case you will be responsible for the delivery costs.

Communication

Many problems can be solved just by speaking to us as your specialist supplier. We know how important it is to you as a user of the fitness equipment to have problems solved quickly and simply, so you can enjoy working out with minimal interruption. For that reason, we also want to resolve your queries quickly and in a straightforward manner. Thus, please always keep your customer number and the serial number of the faulty equipment handy.

DE	DK	UK
<p>TECHNIK</p> <p> +49 4621 4210-900</p> <p> +49 4621 4210-698</p> <p> technik@fitshop.de</p> <p> Öffnungszeiten entnehmen Sie unserer Homepage.</p> <p>SERVICE</p> <p> 0800 20 20277 (kostenlos)</p> <p> 04621 4210 - 0</p> <p> info@fitshop.de</p> <p> Öffnungszeiten entnehmen Sie unserer Homepage: https://stg.fit/statita</p>	<p>TEKNIK OG SERVICE</p> <p> 80 90 16 50</p> <p>+49 4621 4210-945</p> <p> info@fitshop.dk</p> <p> Åbningstider kan findes på hjemmesiden: https://stg.fit/statit7</p> <p>FR</p> <p>TECHNIQUE & SERVICE</p> <p> +33 (0) 189 530984</p> <p>+49 4621 42 10 933</p> <p> info@fitshop.fr</p> <p> Vous trouverez les heures d'ouverture sur notre site Internet: https://stg.fit/statit4</p>	<p>CUSTOMER SUPPORT</p> <p> 00800 2020 2772</p> <p>+494621 4210 944</p> <p> info@fitshop.co.uk</p> <p> You can find the opening hours on our homepage: https://stg.fit/statitc</p> <p>BE</p> <p>TECHNIQUE & SERVICE</p> <p> 02 732 46 77</p> <p>+49 4621 4210 933</p> <p> info@fitshop.be</p> <p> Vous trouverez les heures d'ouverture sur notre site Internet: https://stg.fit/statit8</p>
ES	NL	INT
<p>TECNOLOGÍA Y SERVICIOS</p> <p> 911 238 029</p> <p> info@fitshop.es</p> <p> Consulta nuestro horario de apertura en la página web: https://stg.fit/statit5</p>	<p>TECHNISCHE DIENST & SERVICE</p> <p> +31 172 619961</p> <p> service@fitshop.nl</p> <p> De openingstijden vindt u op onze homepage: https://stg.fit/statit3</p>	<p>TECHNICAL SUPPORT & SERVICE</p> <p> +49 4621 4210-944</p> <p> service-int@fitshop.de</p> <p> You can find the opening hours on our homepage: https://stg.fit/statita</p>
PL	AT	CH
<p>DZIAŁ TECHNICZNY I SERWIS</p> <p> 22 307 43 21</p> <p>+49 4621 42 10-948</p> <p> info@fitshop.pl</p> <p> Godziny otwarcia można znaleźć na stronie głównej: https://stg.fit/statit6</p>	<p>TECHNIK & SERVICE</p> <p> 0800 20 20277 (Freecall)</p> <p>+49 4621 42 10-0</p> <p> info@fitshop.at</p> <p> Öffnungszeiten entnehmen Sie unserer Homepage: https://stg.fit/statitb</p>	<p>TECHNIK & SERVICE</p> <p> 0800 202 027</p> <p>+49 4621 42 10-0</p> <p> info@fitshop.ch</p> <p> Öffnungszeiten entnehmen Sie unserer Homepage: https://stg.fit/statit9</p>

Please find a detailed overview including address and opening hours for all stores of the Fitshop Group in Germany and abroad on the following website:

www.fitshop.com/en/stores

WE LIVE FITNESS

WEBSHOP AND SOCIAL MEDIA

Fitshop is Europe's largest specialist store for home fitness equipment with currently over 70 stores and one of the world's most renowned online mail order companies for fitness equipment. Private customers order via the 25 web shops in the respective national language or have their desired equipment assembled on site. In addition, the company supplies fitness studios, hotels, sports clubs, companies and physio practices with professional equipment for endurance and strength training.

Fitshop offers a wide range of fitness equipment from renowned manufacturers, high-quality in-house developments and comprehensive services, such as a build-up service and sports scientific advice before and after the purchase. The company employs numerous sports scientists, fitness trainers and competitive athletes.

Visit us also on our social media platforms or our blog!



www.fitshop.co.uk
www.fitshop.de/blog



www.facebook.com/fitshop.co.uk



www.instagram.com/fitshop_uk



www.youtube.com/@fitshop_uk

TAURUS



BODYCRAFT



DUKEFITNESS

DARWIN

Notes

Notes

Notes

TAURUS®

Taurus Stair Trainer ST10.5