

TAURUS®

Assembly and Operating Instructions

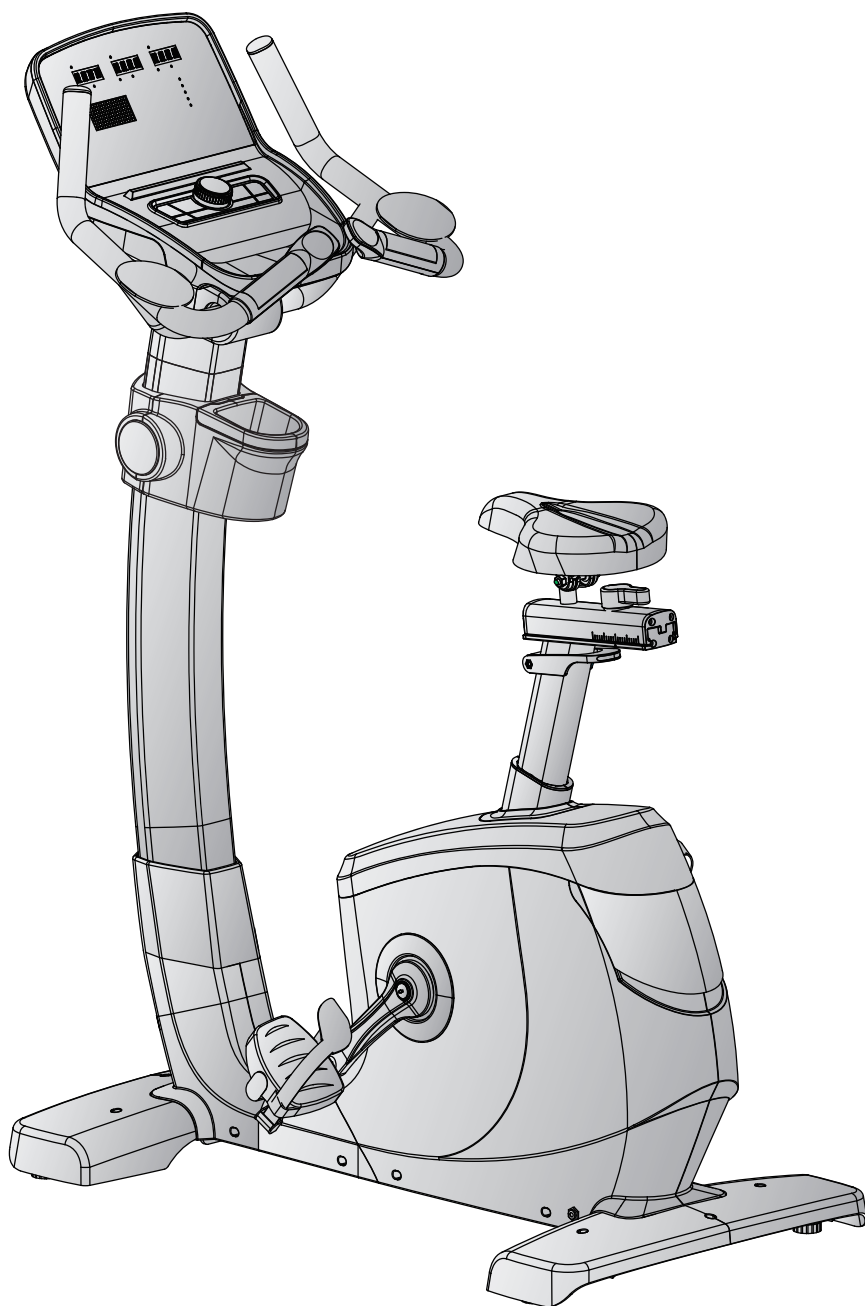

max. 180 kg



~ 90 Min.



58 kg

L 122 | W 61 | H 154

FSTFUB105.02.02

Art.No. TF-UB105-2

Upright Bike UB10.5 Pro

Content

1	GENERAL INFORMATION	8
1.1	Technical Data	8
1.2	Personal Safety	9
1.3	Electrical Safety	10
1.4	Set-Up Place	11
2	ASSEMBLY	12
2.1	General Instructions	12
2.2	Scope of Delivery	13
2.3	Assembly	14
3	OPERATING INSTRUCTIONS	22
3.1	Console display	22
3.2	Button functions	23
3.3	Powering on the equipment	24
3.4	Standby mode	24
3.5	MANUAL (Manual programmes)	25
3.5.1	Quick-Start programme	25
3.5.2	Target programmes	25
3.6	PROGRAM (Profile programmes)	26
3.7	USER (User defined programme)	28
3.8	H.R.C. (Heart rate controlled programmes)	29
3.9	WATT (Watt programme)	30
3.10	RECOVERY (Recovery function)	30
3.11	BODY FAT (Body fat analysis)	31
3.12	Wireless Connection and Fitness Apps	32
4	STORAGE AND TRANSPORT	33
4.1	General Instructions	33
4.2	Transportation Wheels	33
5	TROUBLESHOOTING, CARE AND MAINTENANCE	34
5.1	General Instructions	34
5.2	Faults and Fault Diagnosis	34
5.3	Maintenance and Inspection Calendar	35
6	DISPOSAL	35
7	RECOMMENDED ACCESSORIES	36

8	ORDERING SPARE PARTS	37
8.1	Serial Number and Model Name	37
8.2	Parts List	38
8.3	Exploded Drawing	42
9	WARRANTY	43
10	CONTACT	45

Dear customer,

Thank you for choosing quality training equipment from the TAURUS® brand. Taurus offers sports and fitness equipment for home users with high demands on quality, functionality and longevity. Also, Taurus is a well-known and experienced brand for equipping professional rooms for fitness studios and business customers. The focus of Taurus fitness equipment is on what matters most in sports: maximum performance! Therefore, the devices are developed in close consultation with athletes and sports scientists. Because athletes know best what makes perfect fitness equipment.

Further information can be found at www.fitshop.com.

Intended Use

The equipment may only be used for its intended purpose.

This fitness equipment is suitable for home use, semi-professional use and commercial or professional use. The semi-professional sector includes, for example, institutional facilities such as hospitals, schools, hotels and associations. Professional use refers to commercial use, e.g. in a fitness studio.

Legal Notice

Fitshop GmbH
Europe's No. 1 for home fitness

International Headquarters
Flensburger Straße 55
24837 Schleswig
Germany

Management:
Christian Grau
Sebastian Campmann
Dr. Bernhard Schenkel
No. HRB 1000 SL
Local Court Flensburg
European VAT Number: DE813211547

Disclaimer

© TAURUS is a registered brand of the company Fitshop GmbH. All rights reserved. Any use of this trademark without the explicit written permission of Fitshop is prohibited.

Product and manual are subject to change. Technical data can be changed without advance notice.

FITSHOP

Europe's No.1 for Home Fitness

ABOUT THIS MANUAL

Please carefully read the entire manual before installation and first use. The manual will help you to quickly set up the system and explains how to safely use it. Make sure that all persons exercising with the equipment (especially children and persons with physical, sensory, mental or motor disabilities) are informed about this manual and its contents in advance. In case of doubt, responsible persons must supervise the use of the equipment.

Due to ongoing changes and software optimisations, the manual may have to be updated. If you notice any discrepancies during assembly or use, please refer to the manual uploaded to the webshop. The latest manual is always available there.



This equipment has been manufactured according to the latest safety knowledge. As far as possible, potential safety hazards which could cause injury have been eliminated. Make sure to carefully follow the instructions and that all parts are securely in place. If required, read through the instructions again to correct any mistakes.

Training devices must be classified according to accuracy and use. Accuracy classes are only applicable to devices that display training data.

Accuracy classes

Class A: high accuracy.

Class B: medium accuracy.

Class C: low accuracy.

The use classes explain the intended use of the training device.

Use classes

Class S (studio): professional and/or commercial use.

These training devices are intended for the use in training rooms of facilities such as sports clubs, school facilities, hotels, clubs and studios whose access and supervision is specifically regulated by the owner (person with legal responsibility).

Class H (home use): use at home.

These stationary training devices are intended for the use in private homes where access to the training device is regulated by the owner (person with legal responsibility).

Please pay close attention to the safety and maintenance instructions given here. The contract partner cannot be held liable for damage to health, accidents or damage to the equipment when it is not used in accordance with these instructions.

The following safety instructions may appear in this manual:

► **ATTENTION**

This notice indicates potentially hazardous situations which, if not avoided, may result in property damage.

⚠ **CAUTION**

This notice indicates potentially hazardous situations which, if not avoided, may result in slight or minor injuries!

⚠ **WARNING**

This notice indicates potentially hazardous situations which, if not avoided, may result in death or serious injuries!

⚠ **DANGER**

This notice indicates potentially hazardous situations which, if not avoided, will result in death or serious injuries!

ⓘ **NOTICE**

This notice indicates further useful information.

Retain these instructions in a safe place for future reference, maintenance or when ordering replacement parts.

1.1 Technical Data

LCD Display:

- + Training duration in min.
- + Speed in km/h
- + Training distance in km
- + Calories in kcal
- + Heart rate (using the hand pulse sensors or a chest strap)
- + RPM
- + Watts

Brake system:	Electro-magnetic induction brake
Resistance levels:	32
Flywheel mass:	10 kg

Wattage	
Adjustable range in the watt programme:	10-350 W
Min. and max. Watt at 60 RPM:	20-300 W
Min. and max. Watt at 100 RPM:	73-569 W

User memory:	4
Programmes in total:	23
Quick Start programmes:	1
Target programmes:	4
Pre-set programmes:	12
User defined programmes:	1 (per user)
Heart rate programmes:	4
Watt programmes:	1
Recovery test:	1
Fitness test:	1

Weight and Dimensions:

Package dimensions (LxWxH):	123 cm x 36 cm x 78 cm
Set-up dimensions (LxWxH):	122 cm x 61 cm x 154 cm
Article weight (gross, incl. packaging):	69 kg
Artikelgewicht (net, without packaging):	58 kg

Maximum user weight:	180 kg
----------------------	--------

Use class:	S
------------	---

1.2 Personal Safety

DANGER

- + Before you start using the equipment, you should consult your physician that this type of exercise is suitable for you from a health perspective. Particularly affected are persons who: have a hereditary disposition to high blood pressure or heart disease, are over the age of 45, smoke, have high cholesterol values, are overweight and/or have not exercised regularly in the past year. If you are under medical treatment that affects your heart rate, medical advice is absolutely essential.
- + Note that excessive training can seriously endanger your health. Please also note that heart rate monitoring systems can be inaccurate. If you notice any signs of weakness, nausea, dizziness, pain, shortness of breath, or other abnormal symptoms, stop exercising immediately and seek advice from your doctor if necessary.
- + The owner must communicate all warnings and instructions to the user.

WARNING

- + This equipment may not be used by children under the age of 14.
- + Children should not be allowed unsupervised access to the equipment.
- + Persons with disabilities must have a medical license and must be under strict observation when using the equipment.
- + The equipment is strictly for use by one person at a time.
- + If your equipment provides a safety key, the clip of the safety key must be attached to your clothing before starting your training. In the event of a fall, the EMERGENCY STOP of the equipment can be initiated.
- + There is a risk of injury from spinning pedals and/or an exposed flywheel in the absence of a freewheel. Never get on or off the equipment when the pedals or the flywheel are still moving. Always make sure that the pedals and the flywheel have come to a complete stop.
- + Support yourself with at least one hand on the handlebar when getting on and off the equipment. Only dismount from the equipment when the pedals have come to a complete stop.
- + Keep your hands, feet and other body parts, hair, clothing, jewellery and other objects well clear of moving parts.
- + During use, wear suitable sports clothing rather than loose or baggy clothing. When wearing sports shoes, make sure they have suitable soles, preferably made of rubber or other non-slip materials. Shoes with heels, leather soles, studs or spikes are unsuitable. Never exercise barefoot.

CAUTION

- + If your equipment needs to be connected to the power supply with a mains cable, make sure that the cable is not a potential tripping hazard.
- + Make sure that nobody is within the range of motion of the equipment during training so as not to endanger you or other persons.
- + Always tighten the pedal strap before you start training to prevent your feet from slipping.

 **CAUTION**

- + Be aware that if adjustment devices are left protruding, they may impede the user's movement.

 **ATTENTION**

- + Do not insert any objects of any kind into the openings of the device.
- + To protect the equipment from use by unauthorised third parties, always remove the power cable when not in use and store it in a safe place that is inaccessible to unauthorised persons (e.g. children).
- + Class B and C crank training equipment is not suitable for high accuracy purposes.

1.3 Electrical Safety

 **DANGER**

- + In order to reduce the risk of an electric shock, always unplug the equipment from the mains socket immediately after your workout, before assembly or dismantling, and before maintenance or cleaning. Do not pull on the cable.

 **WARNING**

- + Do not leave the equipment unattended while the mains cable is plugged into the mains socket. During your absence, the mains cable must be removed from the mains socket to prevent improper use by third parties or children.
- + If the mains cable or plug is damaged or defective, contact your contract partner. Until repair, the equipment must not be used.

 **ATTENTION**

- + The equipment requires a mains connection of 220-230 V with 50 Hz mains voltage.
- + The equipment may only be connected directly to an earthed socket using the supplied mains cable. Extension cables must conform to VDE guidelines. Always completely unwind the mains cable.
- + The socket must be protected by a fuse with a minimum fuse rating of "16 A, slow blow".
- + Do not make any changes to the mains cable or the mains plug.
- + Keep the mains cable away from water, heat, oil and sharp edges. Do not route the mains cable underneath the equipment or under a carpet or rug, and do not place any objects on top of it.
- + If your purchased item is equipped with a TFT console, software updates must be carried out regularly. Follow the instructions on the console to perform the update(s).
- + The software systems on gym equipment with TFT consoles are set up only for the pre-installed apps. Do not install any additional apps.

 **NOTICE**

- + The pre-installed apps on TFT consoles are produced and provided by external manufacturers. Fitshop does not take any responsibility for the availability, functionality or contents of these apps.

1.4 Set-Up Place

WARNING

- + Do not place the equipment in main corridors or escape routes.

CAUTION

- + Choose a location in which to place the equipment such that there is enough free space/clearance to the front, the rear and to the sides of the equipment.
- + The training room should be well ventilated during training and not be exposed to any draughts.
- + Choose the place in which to set up the equipment such that there is enough free space/clearance to the front, the rear and to the sides of the equipment.
- + The free area in the direction from which the exercise equipment is accessed must be at least 0.6 m larger than the exercise area.
- + The set-up and mounting surface of the equipment should be flat, loadable and solid.

ATTENTION

- + The device may only be used in one building, in sufficiently tempered and dry rooms (ambient temperatures between 10°C and 35°C). The equipment should not be used outdoors or in rooms with high humidity (over 70%) like swimming pools.
- + A floor protective mat/equipment underlay can help to protect high-quality floor coverings (parquet, laminate, cork, carpets) from dents and sweat and can help to level out slight unevenness.
- + For Class S equipment, the exercise equipment may only be used in areas where access, supervision and control are specifically regulated by the owner.

2.1 General Instructions



DANGER

- + Do not leave any tools, packaging materials such as foils or small parts lying around, as otherwise there is a danger of suffocation for children. Keep children away from the equipment during assembly.



WARNING

- + Pay attention to the instructions attached to the equipment in order to reduce the risk of injuries.



CAUTION

- + Ensure to have sufficient room for movement in each direction during assembly.
- + The assembly of the equipment must be carried out by at least two adults. If in doubt, seek the help of a third technically skilled person.



ATTENTION

- + To prevent damage to the equipment and the floor, assemble the equipment on a mat or packaging board.



NOTICE

- + In order to make the assembly as simple as possible, some screws and nuts to be used can already be pre-assembled.
- + Ideally, assemble the equipment at its later set-up place.

2.2 Scope of Delivery

The scope of delivery consist of the following parts. At the beginning, check whether all parts and tools belonging to the device are included in the scope of delivery and whether damage has occurred. In the event of complaints, the contractual partner must be contacted directly.

CAUTION

If parts of the scope of delivery are missing or damaged, the assembly must not be carried out.

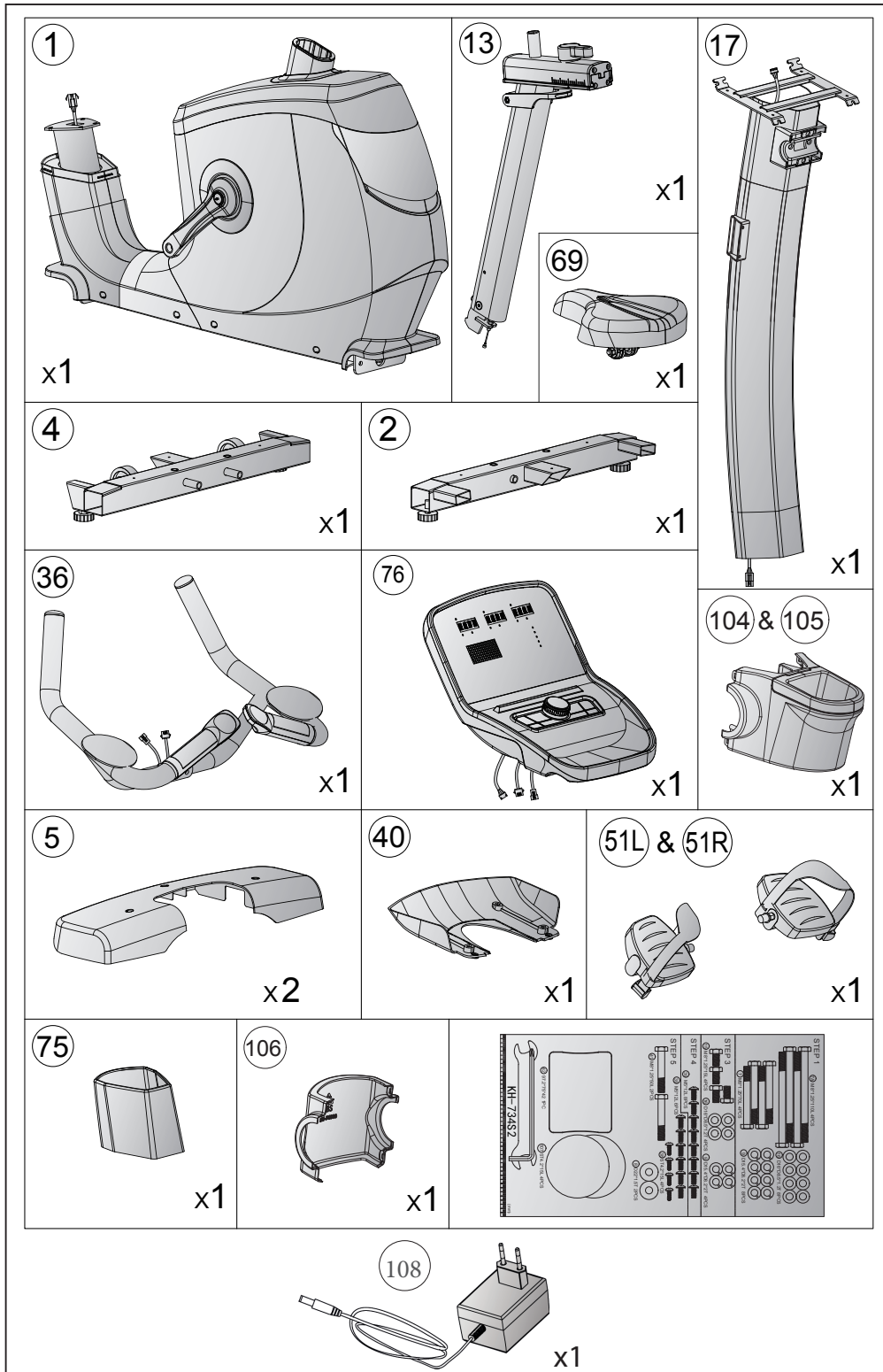

2.3 Assembly

Before assembly, take a close look at the individual assembly steps shown and carry out the assembly in the order given.

NOTICE

- + First loosely screw all parts together and check that they fit properly. Tighten the screws using the tool only when you are instructed to do so.
- + If you have difficulty recognising the graphics, we recommend that you open and/or download the PDF instructions stored in the webshop on your end device (e.g. smartphone, tablet or PC). There you have the option of zooming in closer. Please note that the Adobe Acrobat Reader programme must be installed on your end device in order to open the file.

Step 1: Mounting the front and rear stabiliser

CAUTION

For this assembly step, the device must be lifted on one side. For this purpose, consult the help of another person. For additional stabilisation, you can use the polystyrene from the packaging material and place it under the device.

1. Remove and dispose the front attachment of the unit together with the two screws (see fig. 1-1). These are not required for assembly.
2. Lift the front frame and mount the front stabiliser (4) to the main frame (1) with four washers (16), four spring washers (9), two screws (7A), two screws (7) (see fig. 1-2) and hand-tighten the screws.
3. Remove and dispose the rear attachment of the unit together with the two screws (see fig. 1-3). These are not required for assembly.
4. Lift the rear frame and mount the rear stabiliser (2) to the main frame (1) with four washers (16), four spring washers (9), two screws (7A), two screws (7) (see fig. 1-4) and hand-tighten the screws.

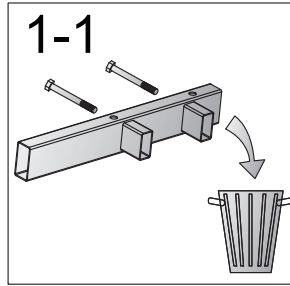
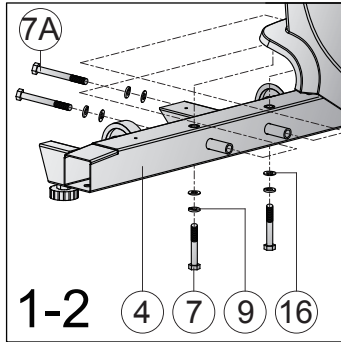

7		M8x1.25x70L	x4
7A		M8x1.25x110L	x4
9		D15.4xD8.2x2T	x8
16		D16xD8.5x1.2T	x8

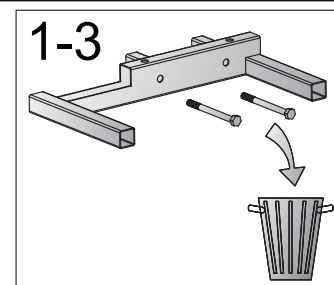
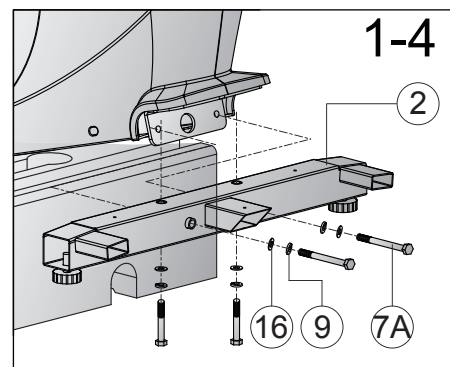
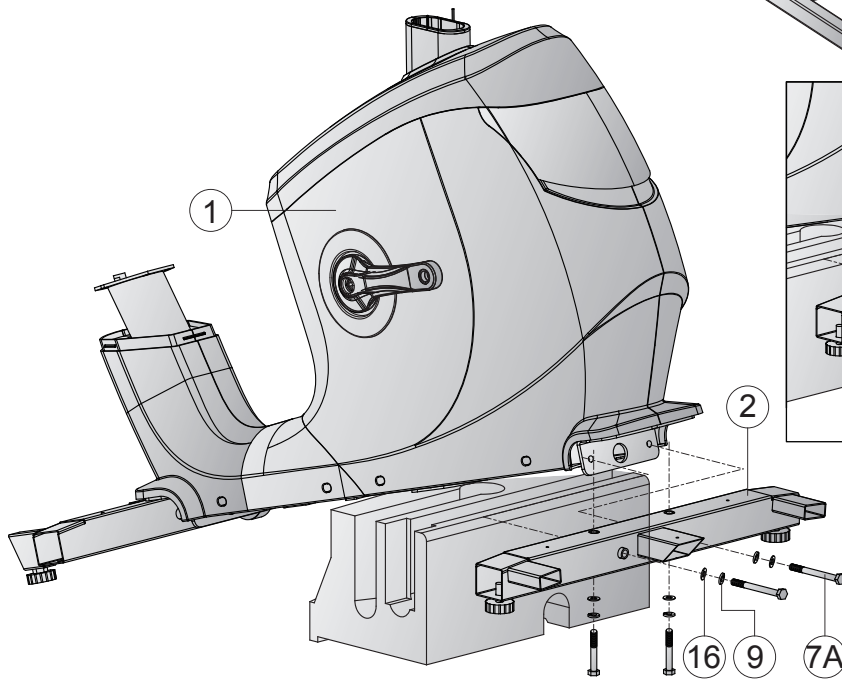
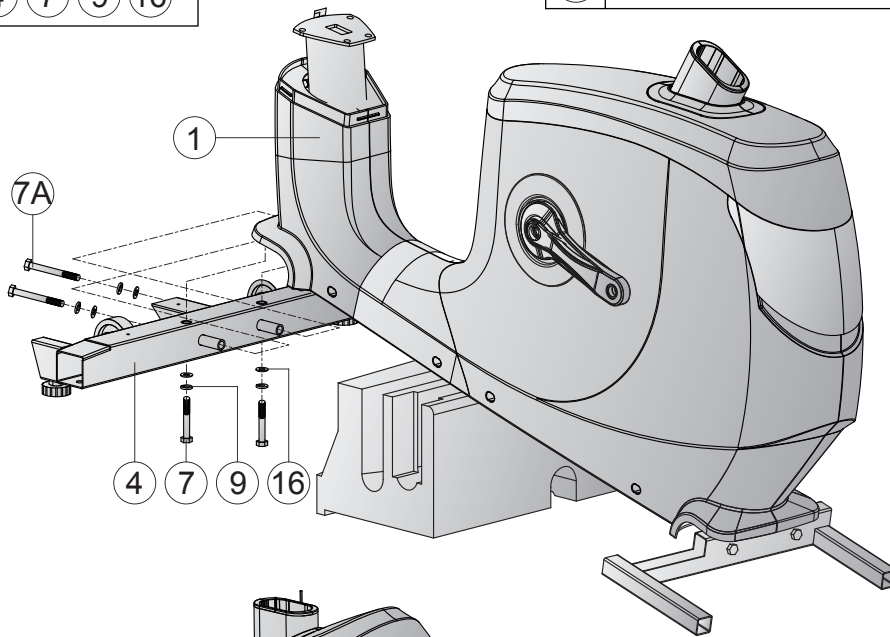

Step 2: Mounting the saddle

1. Mount the saddle to the seat post (13) and hand-tighten the nuts with the tool (see figs. 2-1 and 2-2).
2. Pull the lock on the seat post (13) towards the saddle and insert the seat post (13) into the main frame (1) (see fig. 2-3).

ⓘ NOTICE

If the seat position does not meet your requirements after assembly has been completed, the height of the seat and its lateral alignment can be adjusted as shown in figs. 2-3 and 2-4.

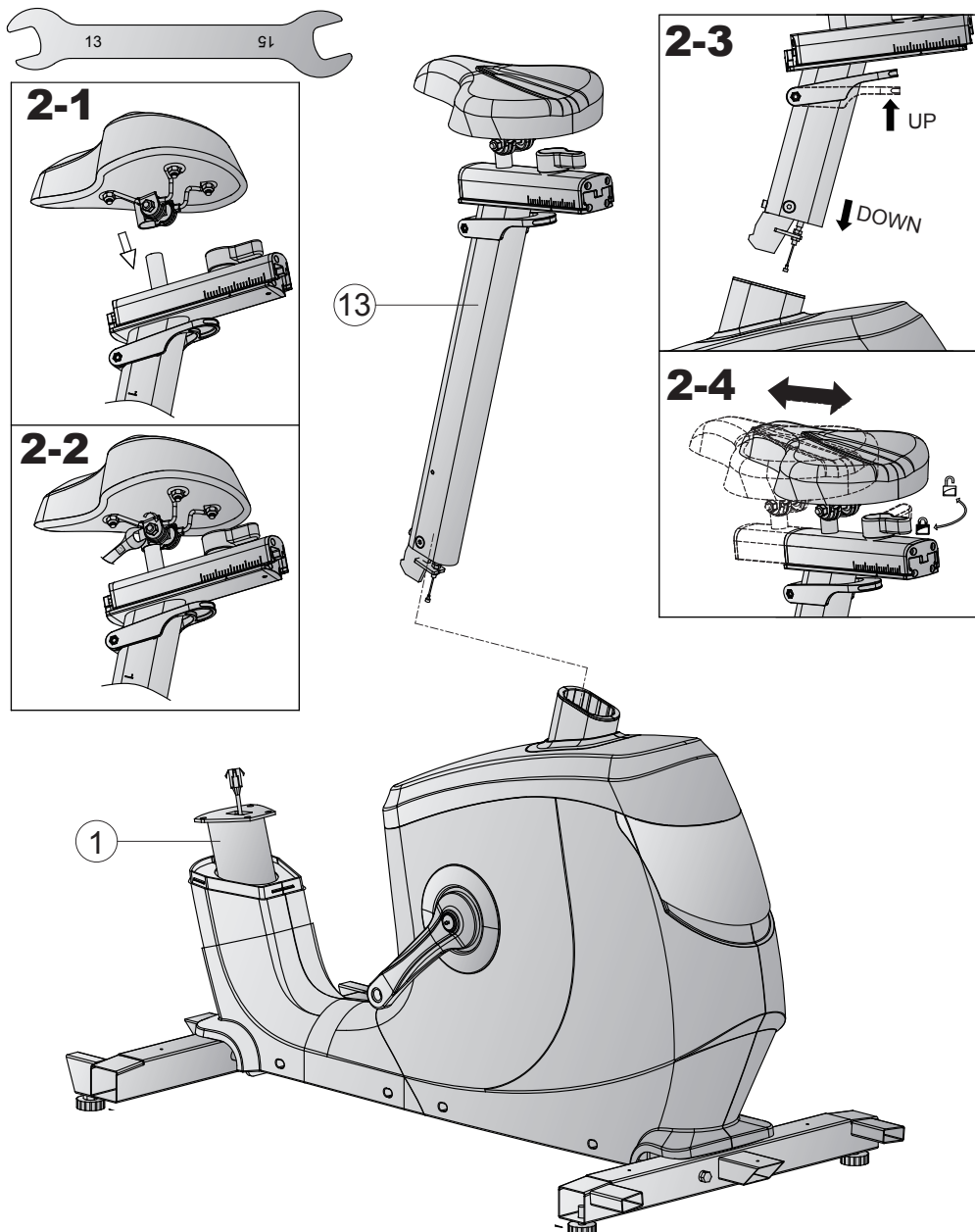

Step 3: Mounting the front post

1. Slide the cover (75) on the front post (17) upwards (see fig. 3-1).
2. Connect the two console cables (64 & 65) together (see fig. 3-2).

► **ATTENTION**

Make sure not to clamp the cables during the next step.

3. Place the front post (17) on the main frame (1) and mount the front post (17) with four washers (16), four spring washers (9) and four screws (15).
4. Slide the cover (75) down and let snap the cover into place.

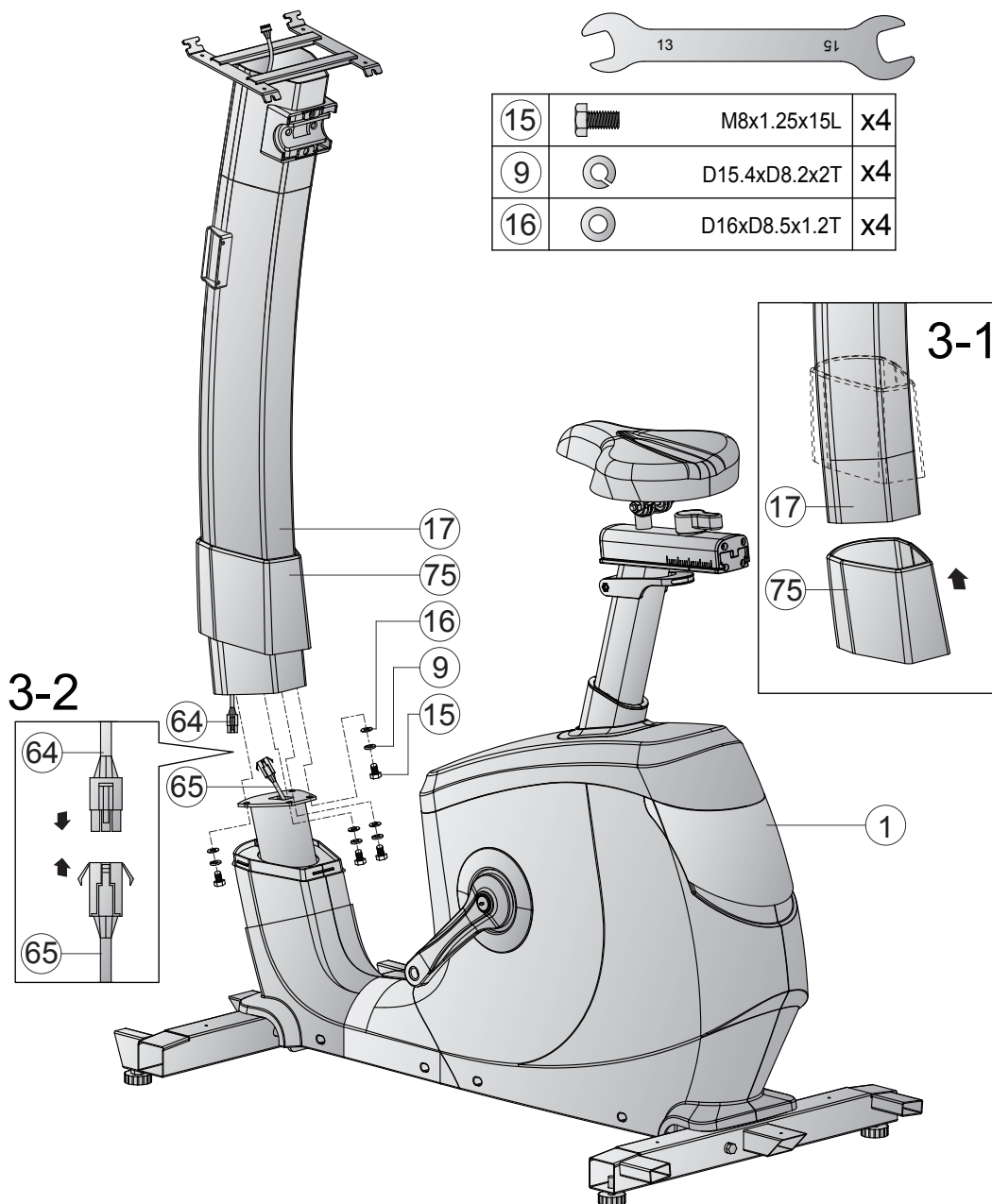

Step 4: Mounting the console

1. Connect the console cable (64) to the console cable (76) shown in figure 4-1.
2. Pass the remaining console cables from the console (76) through the front post opening (17) (see fig. 4-2).
3. Mount the console (76) on the front post (17) with four screws (39) (see fig. 4-3) and hand-tighten the screws.
4. Mount the console cover (40) below the console (76) on the front post (17) using four screws (39) (see fig. 4-4) and hand-tighten the screws.

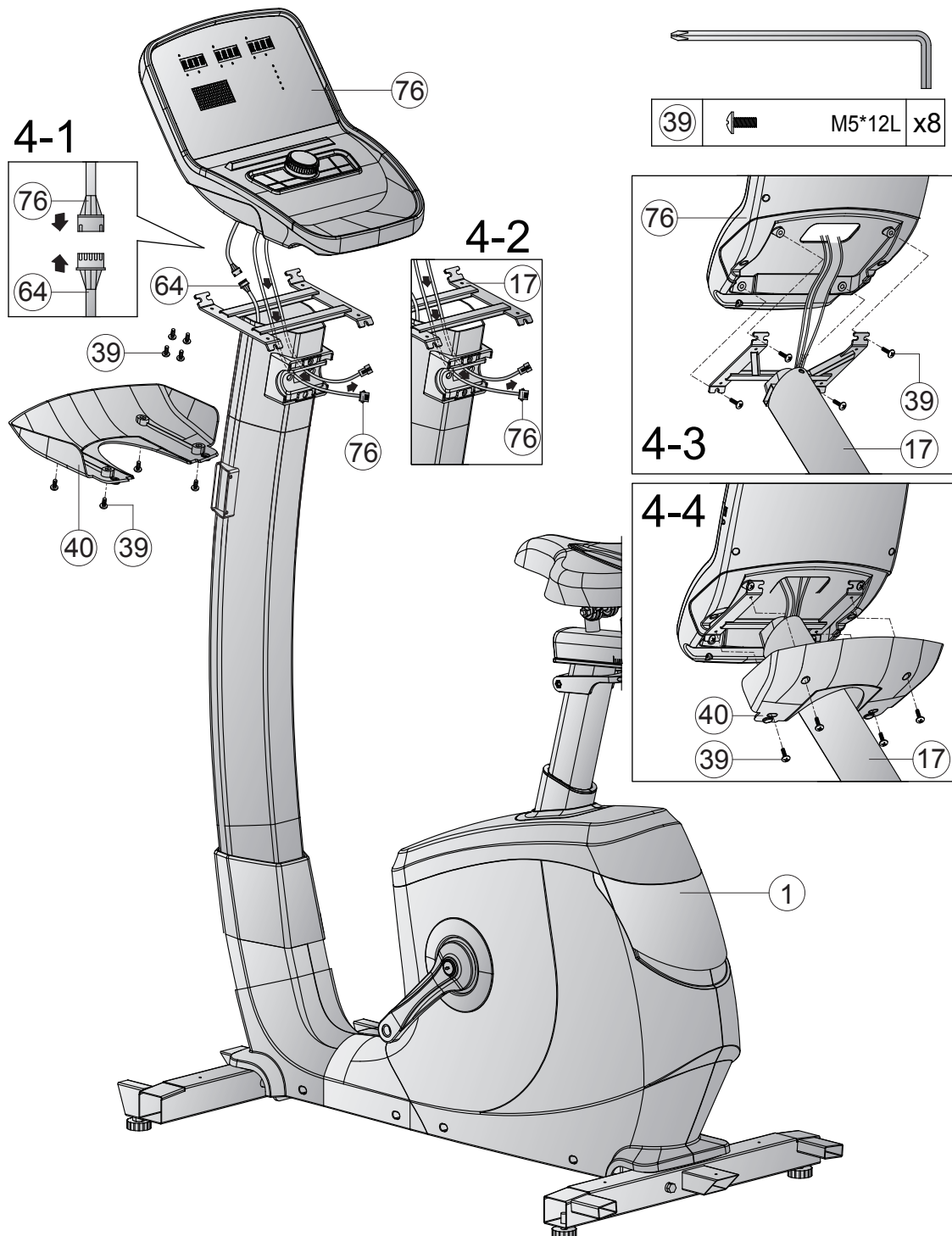

Step 5: Mounting the handles and bottle holder

1. Connect the cables from the console (76) to the cables for the speed buttons (37L & 37R).
2. Mount the handlebar (36) to the front post (17) using two curved washers (8) and two screws (41) and hand-tighten the screws.
3. Place the cover for the handlebar (42) on the screw connection.
4. Mount the rear bottle bracket (105) to the front post (17) using four screws (38) (see fig. 5-1).
5. Place the two end caps (107) into the rear bottle bracket (105) (see fig. 5-2).
6. Snap the front bottle bracket (106) into the rear bottle bracket (105) (see fig. 5-3).

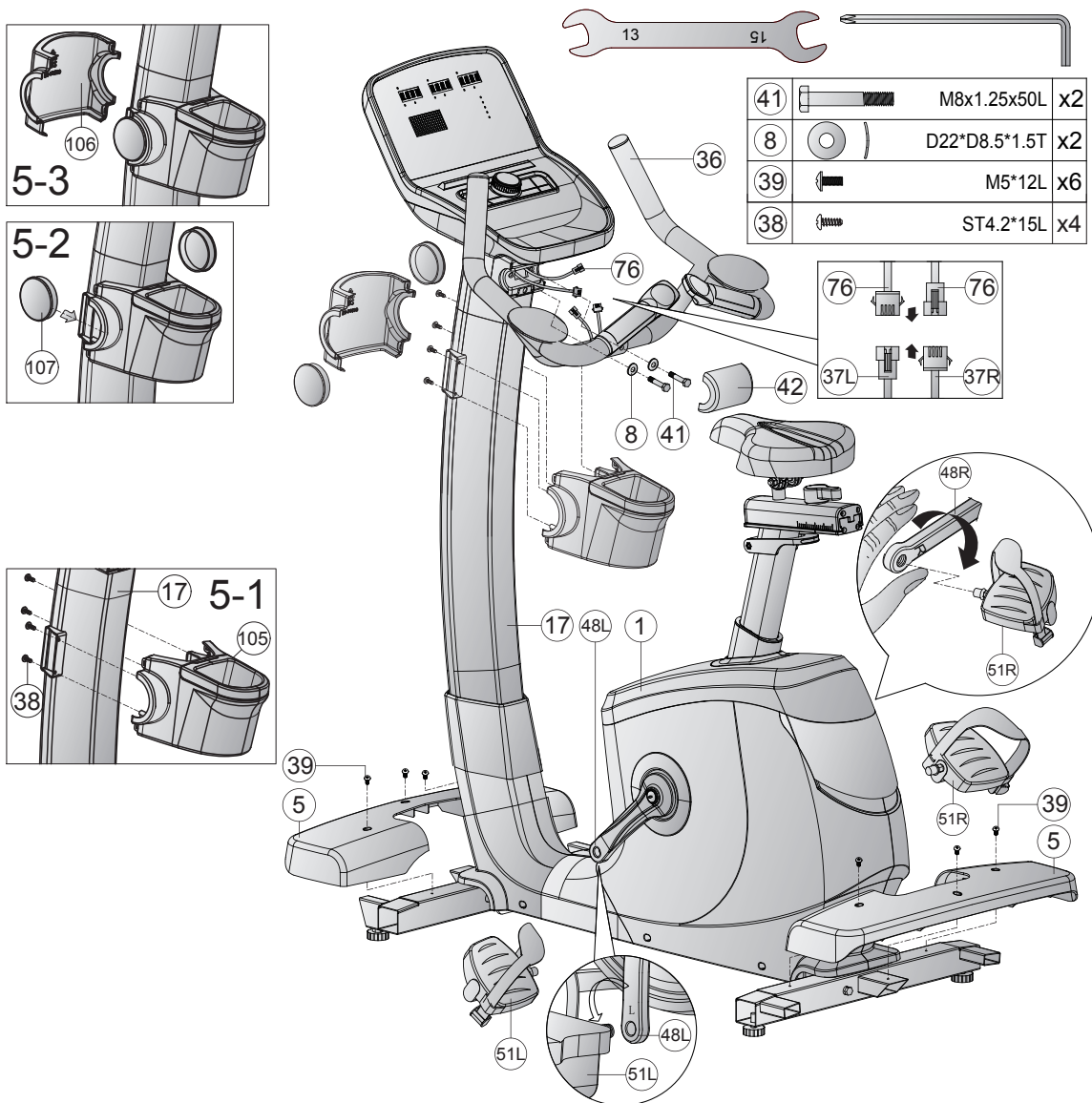

Step 6: Mounting the pedals and foot covers

1. Turn the left pedal (51L) counterclockwise on the left crank (48L) on the main frame (1).
2. Turn the right pedal (51R) clockwise on the right crank (48R) on the main frame (1).



CAUTION

Make sure to screw in the pedals completely.

3. Place the rear and front covers (5) on the rear and front stabilizers (2 & 4) and mount each cover (5) with three screws (39).

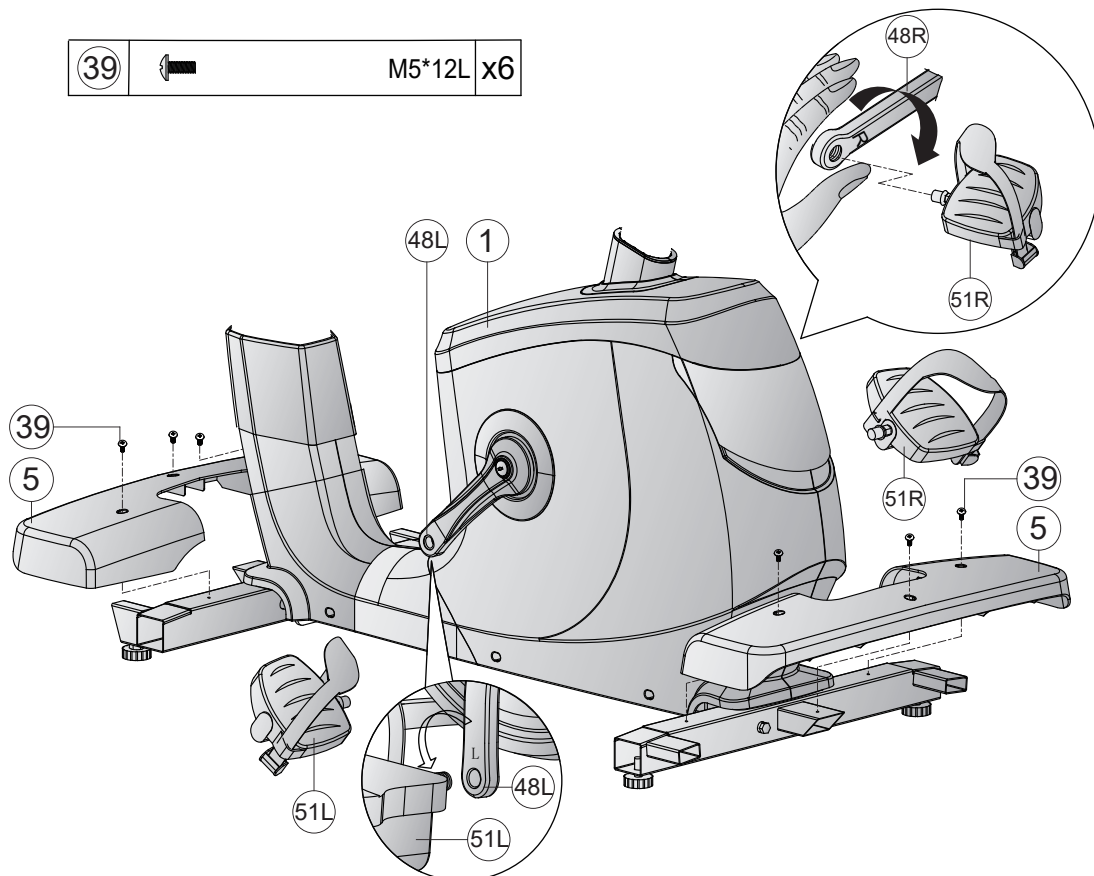

Step 7: Alignment of the feet

If the floor is uneven, you can stabilise the equipment by turning the adjustable screws under the main frame.

1. Lift the equipment on the desired side and rotate the adjustable screws under the main frame.
2. Rotate the screws clockwise in order to unscrew them, therefore raising the equipment.
3. Rotate the screws counterclockwise in order to lower the equipment.

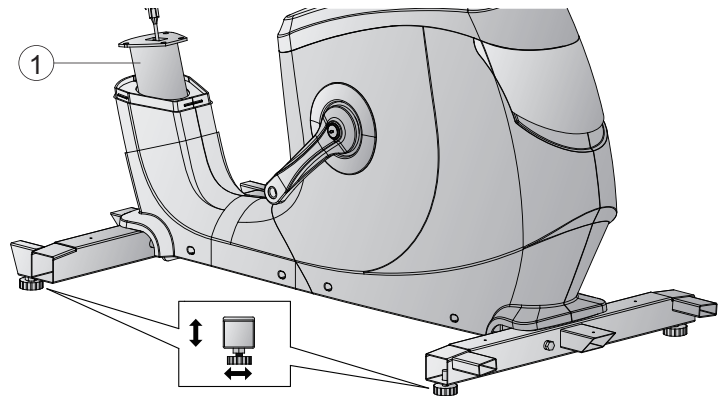

Step 8: Connecting the equipment to the mains supply

▶ ATTENTION

The equipment must not be connected to a power board, otherwise it cannot be guaranteed that the equipment will be supplied with sufficient power. Technical errors can result.

ⓘ NOTICE

The mains plug should only be used if the battery charge is insufficient.

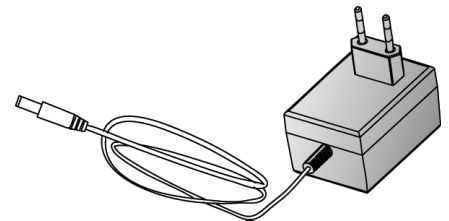

Connect the adaptor (108) to the unit and then plug the adaptor (108) into a wall socket that complies with the specifications in the chapter on electrical safety.

The adaptor included in the package is used to charge the battery, which is installed inside the console.

Please notice the following precautions, otherwise the performance of the battery may decrease:

1. If the battery is fully discharged, it must be recharged for 8 to 10 hours.
2. If the battery is partially discharged, it must be charged for 1 to 4 hours.
3. If you do not plan to use the device for a longer period of time, charge the battery completely before storing the device.
4. The fully charged battery must be recharged after one month of storage.

Correctly Getting On and Off

1. To get on, grip the handles with both hands and first step onto the left pedal with your left foot or onto the right pedal with your right foot and then place your foot onto the other pedal.
2. To get off, grip the handles with both hands and place one foot next to the equipment and then the other foot.

3 OPERATING INSTRUCTIONS

NOTICE

- + Familiarise yourself with all the functions and setting options of the device before starting training. Have the proper use of this product explained to you by a specialist.
- + Always start your training with low intensity and increase evenly and gently. End your training with a cool-down phase. If you are unsure, please consult your physician.

3.1 Console display

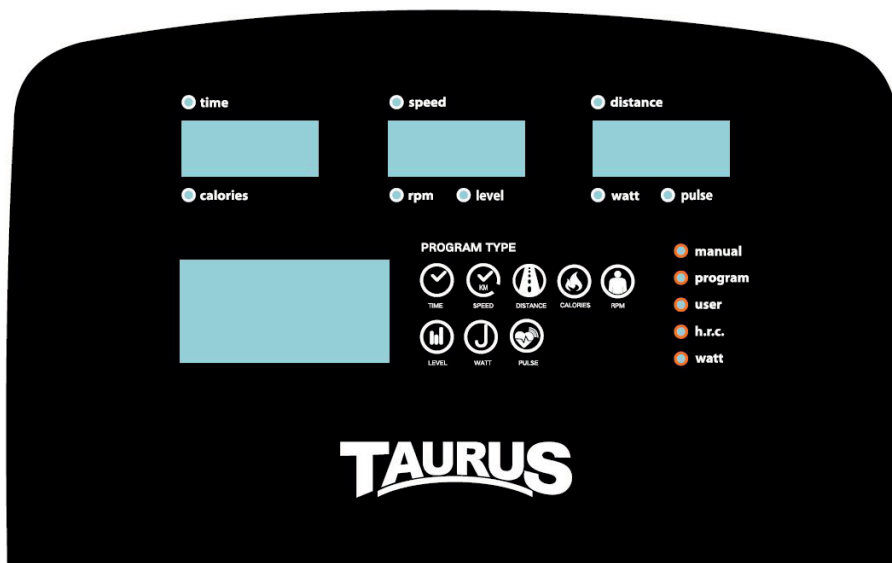

DISPLAY	DESCRIPTION
TIME	+ Display of the elapsed training time (0:00 - 99:59) + Set a target time with the rotary knob (0:00 - 99:00) in 1 min. increments-
SPEED	Display of the current speed (max. 99.9)
DISTANCE	+ Display of the distance covered (0.00-99.99) + Set a target distance with the rotary knob (0.00-99.0) in 1km increments
CALORIES	+ Display of the calories burned (0-9999) + Set a target calorie value with the rotary knob (0-9999) in 10 Cal. increments-
RPM	Display of the current revolutions per minute (RPM) (0-999)
LEVEL	Display of the current resistance level
WATTS	Display of the Watt value (0 -999)
PULSE	+ Display of your heart rate (0-230) + Set a heart rate target with the rotary knob (0-30-230) in singular increments

3.2 Button functions

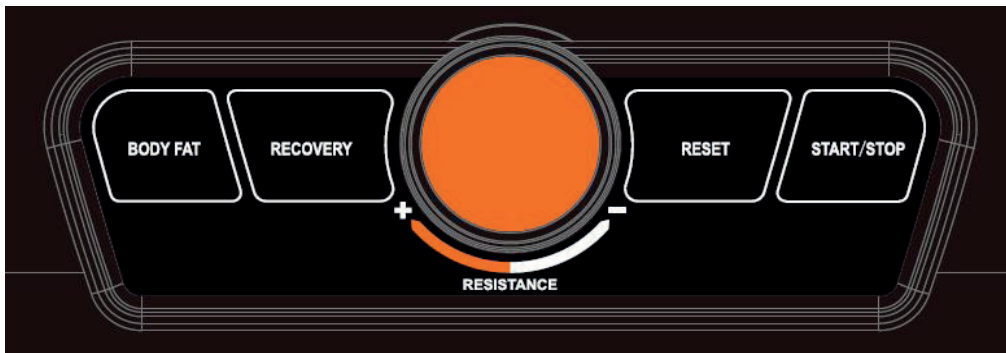

BUTTON	DESCRIPTION
Rotary knob	<ul style="list-style-type: none">+ Increasing the setting value or resistance level+ Decreasing the setting value or resistance level+ Setting confirmation
BODY FAT	Body fat test
RECOVERY	Heart rate test on your recovery condition
RESET	Returns you to the previous training mode while making settings or selecting an option. To reset the console, press and hold the button for 2 seconds
START/STOP	Start and stop your training

3.3 Powering on the equipment

The console starts automatically as soon as the exercise bike is plugged into the mains supply. Various components will light up.

1. Choose a user profile (U1 - U4).
2. Enter in your gender (SEX), age (AGE), height (HEIGHT) and weight (WEIGHT).

You will proceed onto the main menu.

In the main menu you can choose from the different programmes.

- + MANUAL (Quick-Start and target programmes)
- + PROGRAM (Profile programmes)
- + USER PROGRAM (user defined programme)
- + H.R.C (Heart rate controlled programmes)
- + WATT (Watt programme)

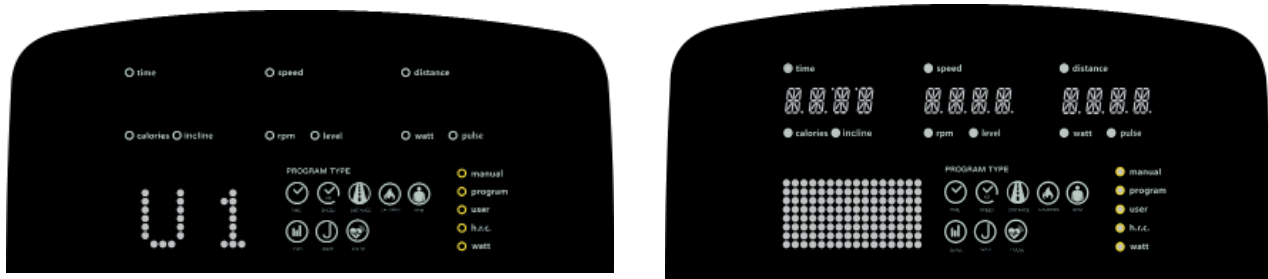

3.4 Standby mode

The console goes into standby mode after four minutes without inputs or movement. The console will exit standby mode as soon as it registers movement.

3.5 MANUAL (Manual programmes)

Under MANUAL you can choose between the Quick-Start programme and one of the target programmes. For target programmes, settings for time (TIME), distance (DISTANCE), calories (CALORIES) or heart rate (PULSE) are possible.

3.5.1 Quick-Start programme

1. In the main menu, select MANUAL and confirm your choice with a single push of the rotary knob.
2. To start the Quick-Start programme, just press the START/STOP button.

Various values will start counting upwards.

3. To pause the programme, press the START/STOP button again.
4. To end the programme, press the RESET button.



3.5.2 Target programmes

You have two choices for target programmes. The target programme can have a singular or multiple targets set.

Training with a singular target value

1. In the main menu select MANUAL and confirm your choice with a single push of the rotary knob.
2. Select your target value for time, calories, distance or heart rate with the rotary knob and confirm your choice with a single push of the rotary knob.



WARNING

This Crosstrainer is not medical equipment. The heart rate measurement of the Crosstrainer can be unprecise. Different factors can influence the heart rate reading. The heart rate readings are only meant as a guide for training.

3. To start the programme, press the START/STOP button.

NOTICE

During training it is possible to change the resistance level with the rotary knob.

The target value counts down and the other values count upwards.

4. To pause the programme, press the START/STOP button again.
5. To end the programme, press the RESET button.

Training with multiple target values

1. In the main menu select MANUAL and confirm your choice with a single push of the rotary knob.
2. Select your target value for time, calories, distance and/or heart rate with the rotary knob and confirm your choice with a single push of the rotary knob.



WARNING

This crosstrainer is not medical equipment. The heart rate measurement of the crosstrainer can be unprecise. Different factors can influence the heart rate reading. The heart rate readings are only meant as a guide for training.

3. To start the programme, press the START/STOP button.

NOTICE

During training it is possible to change the resistance level with the rotary knob.

The target values count down and the other values count upwards.

4. To pause the programme, press the START/STOP button again.
5. To end the programme, press the RESET button.

3.6 PROGRAM (Profile programmes)

There are a total of 12 profile programmes available to choose from.

1. In the main menu select PROGRAM and confirm your choice with a single push of the rotary knob.
2. Using the rotary knob select one of the profile programmes and confirm your choice with a single push of the rotary knob.
3. Using the rotary knob select the training time and confirm the setting with a single push of the rotary knob.



4. To start the programme, press the START/STOP button.

NOTICE

During training it is possible to change the resistance level with the rotary knob.

5. To pause the programme, press the START/STOP button again.

NOTICE

While the programme is paused it is possible to change the training time.

6. To end the programme, press the RESET button.

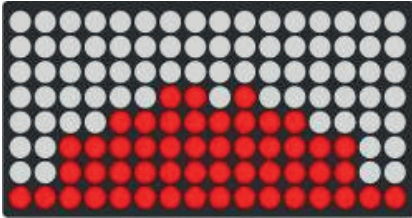

P1

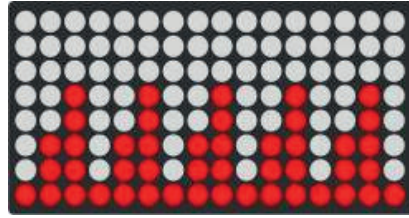

P2

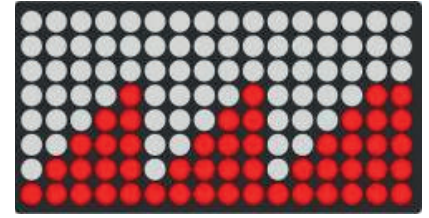

P3

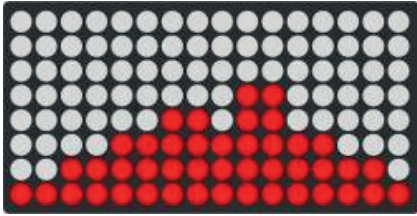

P4



P5



P6

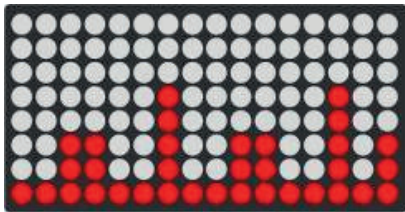

P7

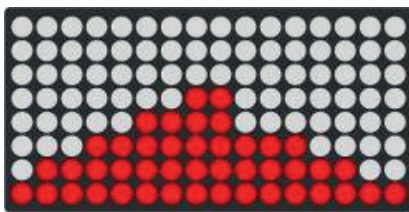

P8

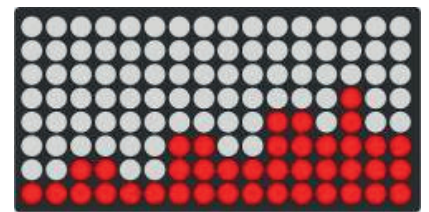

P9

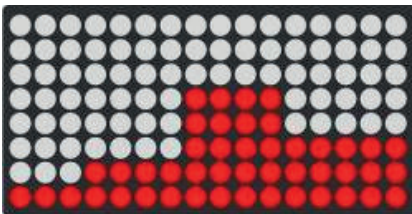

P10

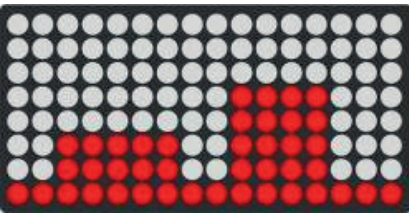

P11

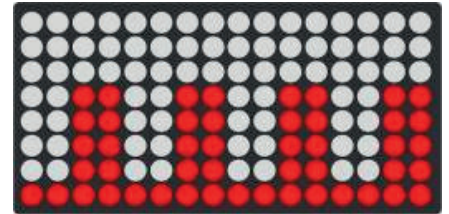

P12

3.7 USER (User defined programme)

There are 16 segments available in user defined programmes.

1. In the main menu select USER and confirm your choice with a single push of the rotary knob.
2. Select the resistance level of each segment and confirm each value with a single push of the rotary knob.
3. To end setting the resistance levels, press and hold the rotary knob for 2 seconds.



The last set level is shown on the display.

You now have the option to set training time with the rotary knob.

4. Using the rotary knob, select the training time and confirm the setting with a single push of the rotary knob or press the START/STOP button to directly start your training.

NOTICE

During training it is possible to change the resistance level with the rotary knob.

5. To pause the programme, press the START/STOP button again.
6. To end the programme, press the RESET button.

3.8 H.R.C. (Heart rate controlled programmes)

WARNING

This crosstrainer is not medical equipment. The heart rate measurement of the crosstrainer can be unprecise. Different factors can influence the heart rate reading. The heart rate readings are only meant as a guide for training.

There are three heart rate programmes available to choose from. You can choose from one of the three pre-set target heart rate programmes (55%, 75% or 90% of your maximum heart rate) or choose TARGET and manually set a target heart rate value. Your maximum heart rate is calculated by the console and is dependant on your age set. We recommend using a chest heart rate sensor (chest strap) for this programme.



1. In the main menu select H.R.C. and confirm your choice with a single push of the rotary knob.
2. Using the rotary knob select one of the pre-set target heart rate programmes or TARGET and confirm your choice with a single push of the rotary knob.
3. If you have selected TARGET, use the rotary knob select a target heart rate and confirm your setting with a single push of the rotary knob.

NOTICE

The pre-set TARGET value is 100.

- 3.1. Optionally you can also set a time and confirm this with a single push of the rotary knob.
4. To start the programme, press the START/STOP button and hold the hand pulse sensors in your hands or alternatively you can use an optional chest strap.

Your current heart rate will be displayed during training.

NOTICE

If no heart rate is detected, the display will show:



5. To pause the programme, press the START/STOP button again.
6. To end the programme, press the RESET button.

3.9 WATT (Watt programme)

1. In the main menu select WATT and confirm your choice with a single push of the rotary knob.
2. Using the rotary knob, select a Watt value and confirm your setting with a single push of the rotary knob.



NOTICE

The pre-set value is 120.

3. Using the rotary knob select the training time and confirm the setting with a single push of the rotary knob or press the START/STOP button to directly start your training.

NOTICE

The resistance level changes automatically to the set Watt value.

4. To pause the programme, press the START/STOP button again.
5. To end the programme, press the RESET button.

3.10 RECOVERY (Recovery function)

Use the recovery function after a training session to measure your recovery heart rate.

To start the recovery function, press the RECOVERY button and hold the hand pulse sensors or alternatively use an optional chest strap.

The display shows a countdown that runs from 00:60 to 00:00.



NOTICE

If you wish to prematurely end the recovery function, press the RECOVERY button again.

Based on the final pulse readings, once the countdown ends you'll receive a fitness grade from F1 to F6.

F1	Very good
F2	Good
F3	Average
F4	Adequate
F5	Bad
F6	Very bad

3.11 BODY FAT (Body fat analysis)

1. Choose your user profile (U1-U4).
2. To start the body fat analysis, in the main menu press the BODY FAT button and hold on to the hand pulse sensors.

NOTICE

Should you not properly grip the hand pulse sensors, the display will show the error code E-1.

NOTICE

If you wish to prematurely end the body fat analysis and return to the previous program, press the BODY FAT button again.

After successfully ending the test you'll be shown your body fat ratio (FAT%) and your BMI.

NOTICE

Should your body fat ratio be outside of the 5% - 50%, the display will show the error code E-4.



3.12 Wireless Connection and Fitness Apps

This console is equipped with a wireless connection interface. Please take note that your mobile device needs to be compatible with the wireless connection interface of the treadmill.

To use training apps you will have to activate the wireless connection function on your mobile device (tablet or smart phone) and start the fitness app. Select your fitness equipment. Please follow the instructions given in the app. You will find the name of your fitness equipment on a small sticker on the back of the console.

You will find the fitness apps in the app stores of Google or Apple. There you will find the apps "Kinomap" or "Zwift". Please note that these apps are produced by an external manufacturer. Fitshop does not take any responsibility regarding the availability, functionality or contents of these programmes.

IMPORTANT NOTE

The pre-installed apps are produced and provided by external manufacturers. Changes and availability within these apps might occur. Fitshop does not take any responsibility and can not be held liable for the availability, functionality or contents of these apps. To make sure the pre-installed apps are working correctly, they must be updated regularly. If needed, the respective app will notify you to do so. To update the app, you need a google account. A google email is sufficient. Just follow the instructions on the screen to perform the update.

Please note: The system is set up only for the pre-installed apps. Do not install any additional apps as their proper functionality can not be guaranteed. The installation of other apps might cause technical issues.

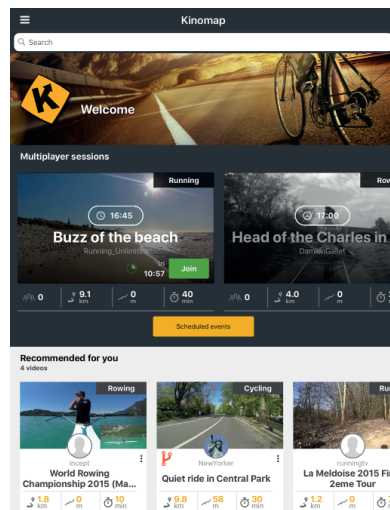
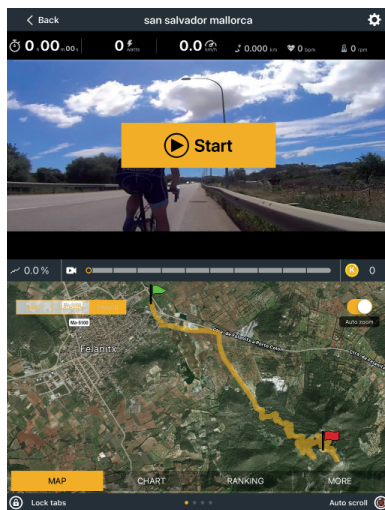
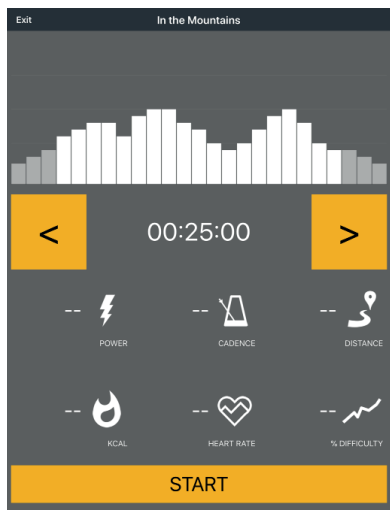

Example: Kinomap

4.1 General Instructions

WARNING

- + The storage location should be chosen so that improper use by third parties or children can be prevented.
- + If your equipment does not have transportation wheels, the equipment must be disassembled before transportation.

▶ ATTENTION

- + Make sure that the equipment is protected from moisture, dust and dirt in the selected storage location. The storage location should be dry and well ventilated and have a constant ambient temperature between 10°C and 35°C.

4.2 Transportation Wheels

▶ ATTENTION

If you want to transport your equipment over particularly sensitive and soft floor coverings, such as parquet, planks or laminate, lay out the transport route with cardboard or similar to avoid possible floor damage.

1. Stand behind the equipment and lift it until the weight is transferred to the transportation wheels. After that, you easily can move the equipment to a new position. For long transport distances the equipment should be disassembled and safely packed.
2. Select the new location by following the instructions in the section 1.4 of this manual.

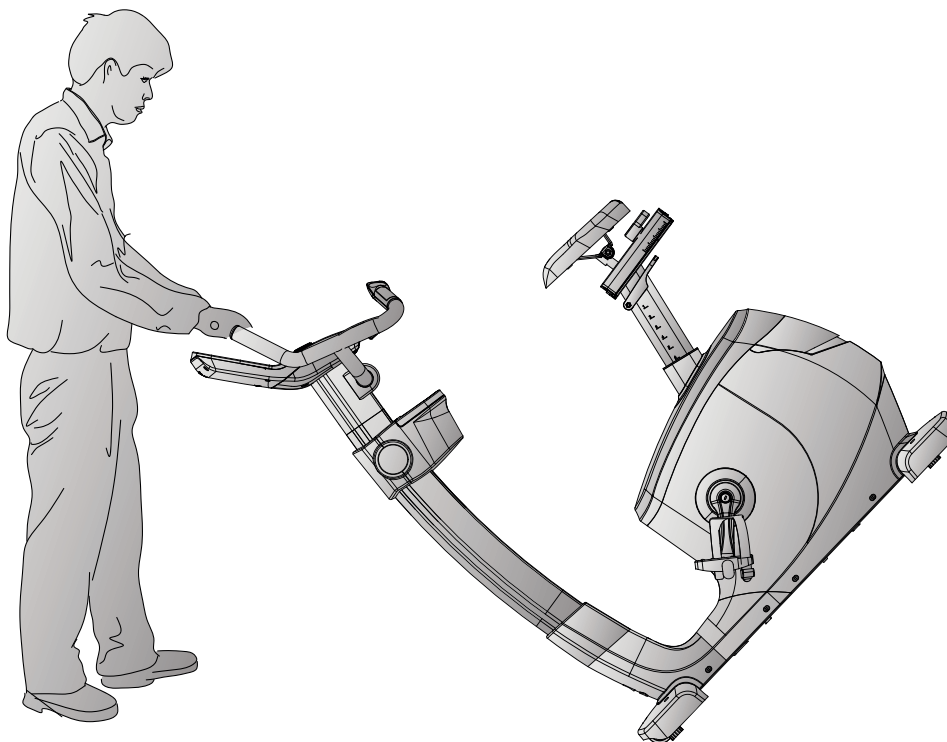

5.1 General Instructions



WARNING

- + Do not make any improper changes to the equipment.



CAUTION

- + Damaged or worn components may affect your safety and the life of the equipment. Therefore, immediately replace damaged or worn components. In such a case, contact the contract partner. The equipment must not be used until it has been repaired. If necessary, use only original spare parts.

► ATTENTION

- + In addition to the instructions and recommendations for maintenance and care given here, additional service and/or repair work may be necessary; this must only be carried out by authorised service technicians.

5.2 Faults and Fault Diagnosis

The equipment undergoes regular quality controls during production. Nevertheless, faults or malfunctions may occur. Frequently, individual parts are responsible for these disturbances, an exchange is usually sufficient. Please refer to the following overview for the most common errors and how to correct them. If the equipment still does not function properly, contact your contract partner.

Fault	Cause	Solution
Cracking in the pedal area	Pedals loose	Tighten the pedals
Equipment wobbles	Equipment is not level	Align the feet
Handlebar/saddle wobbles	Loose screws	Tighten screws firmly
Display is blank/is not working	Batteries empty or loose cable connection	Replace batteries or check cable connections
No pulse display	<ul style="list-style-type: none"> + Sources of interference in the room + unsuitable chest strap + Wrong position of chest strap + Chest strap defective or battery empty + Pulse display defective 	<ul style="list-style-type: none"> + Eliminate sources of interference (e.g. mobile phone, WLAN, lawn mower and vacuum cleaner robot, etc. ...) + Use a suitable chest strap (see RECOMMENDED ACCESSORIES) + Reposition chest strap and/or moisten electrodes + Changing batteries + Check if pulse display by hand pulse possible

5.3 Maintenance and Inspection Calendar

To avoid damage from body sweat, the equipment must be cleaned with a damp towel (no solvents!) after each training session.

The following routine tasks must be performed at the specified intervals:

Part	Weekly	Monthly	Quarterly
Display console	C	I	
Lubrication of moving parts			I
Plastic covers	C	I	
Screws and cable connections		I	
Check pedals for tightness		I	
Legend: C = clean; I = inspect			

By scanning the QR code with the camera function or QR code scanner app of your smartphone/tablet, a video on general maintenance of an exercise bike opens on YouTube. The video serves to illustrate the maintenance points described in this manual.

Please note that the video may not be available in your language or with appropriate subtitles.

If you cannot scan QR codes, you can access all Fitshop videos on YouTube by first opening YouTube and entering "Fitshop" in the search field.



6 DISPOSAL

At the end of its operational life, this equipment cannot be disposed of in normal household waste. Instead, it must be disposed of via an electricals recycling centre. Further information can be obtained from your local authority's recycling service.



The materials can be recycled as per their symbols. Through the reuse, recycling of materials or other forms of recovery of old equipment, you make an important contribution to the protection of the environment.

7 RECOMMENDED ACCESSORIES

To make your training experience even more efficient and pleasant, we recommend that you add suiting accessories to your fitness equipment. For exercise bikes this could for example be a **floor mat**, which makes your fitness equipment stand more securely and also protects the floor from sweat or **silicone spray** to keep moving parts in good shape. For many exercise bikes it is possible to replace the **saddle** or **pedals**, as these are usually the same mounts used on bicycles.

If you have purchased a fitness machine with pulse training and want to train your heart rate, we strongly recommend that you use a compatible **chest strap**, as this ensures optimum transmission of the heart rate.



Our range of accessories offers the highest quality and makes training even better. If you would like to find out more about compatible accessories, please go to the detail page of the product in our webshop (the easiest way is to enter the article number in the search field above) and go to the recommended accessories on this page. Alternatively, you can use the QR code provided. Of course, you can also contact our customer service: by telephone, e-mail, in one of our branches or via our social media channels. We will be happy to advise you!



saddle cover



chest strap



chest strap contact gel



floor mat



saddle



silicone spray

8.1 Serial Number and Model Name

In order to provide you with the best possible service, please have the model name, article number, serial number, exploded drawing and parts list ready. The corresponding contact options can be found in chapter 10 of this operating manual.

NOTICE

The serial number of your equipment is unique. It's located on a white sticker. The exact position of this sticker is shown in the following illustration.

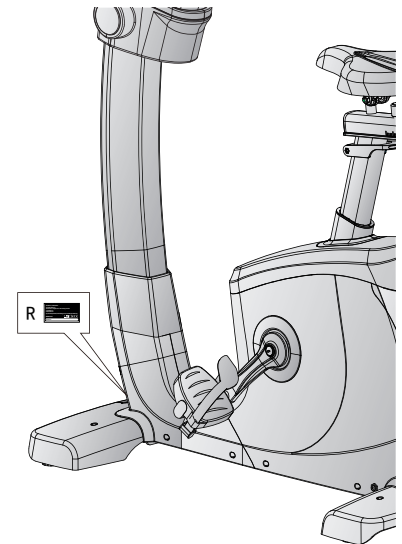

Enter the serial number in the appropriate field.

Serial number:

Brand / Category:

Model Name:

Article Number:

8.2 Parts List

No.	Name	Supplier Parts No.	Specification	Qty.
1	Main frame	734G1-3-1000-BA0		1
2	Rear stabilizer	734S0-3-2112-BA0		1
3	Adjustable round wheel	76100-6-2174-B0	D50*M10*1.5	4
4	Front stabilizer	734S0-3-2100-BA0		1
5	Front stabilizer cover	734S0-6-2186-B0	600*190.2*79.4	2
6	Allen bolt	50308-5-0040-F3	M8*1.25*40L	2
7	Bolt	50108-5-0070-F4	M8*1.25*70L	4
7A	Bolt	50108-5-0110-F5	M8*1.25*110L	4
8	Curved waster	55108-3-2215-FA	D22xD8.5x1.5T	2
9	Spring washer	55108-2-1520-FA	D15.4xD8.2x2T	12
10L	Front left decorative cover(black)	734G0-6-4523-B0	483.5*98.3*256.6	1
10R	Front right decorative cover(black)	734G0-6-4546-B0	483.5*101.7*256.6	1
11	Upper decorative cover	734S0-6-4520-B0	629.3*170.6*114	1
12	Rear cover	734S0-6-4514-B20	191.9*172.1*138.4	1
13	Seat post welding set	734S0-3-2200-A40		1
14	Inner tube	734S0-6-1071-B0	50*100*340L	2
15	Hext bolt	50108-5-0015-F0	M8*1.25*15L	4
16	Flat washer	55108-1-1612-FA	D16*D8.5*1.2T	12
17	Front post	734S2-3-2000-BA1		1
18	Adjustable handle	734S0-6-4084-B0	80*D43*31	1
19	End cap(1)	734S0-6-2286-B0	60*41.8*10T	2
20	End cap(2)	734S0-6-2287-B0	60*28.7*10T	2
21	Bearing	58006-6-1042-00	#6004-2RS(C0) (SKF)	2
22	Waved washer	55120-5-2705-DA	D27*D20.3*0.5T	1
23	Screw	54203-2-0030-F0	M3*0.5*30L	4
24	C ring	55519-1-2312-DA	D22.5*D18.5*1.2T	2
25	Cross screw	54203-2-0012-F0	M3*0.5*12L	2
26	Crank Axle	734S0-3-2903-00		1
27	Pulley wheel	58008-6-1037-D0	D260*25*3T	1
28	Anti-loosen nut	55206-1-2006-FA	M6*1.0*6T	5
29	Hex bolt	50106-5-0015-C0	M6x1.0x15L	4

30	Multi-groove belt	58004-6-1114-00	450 PJ8	1
31	Round magnet	174R4-6-2574-00	M02	1
32L	Upper cable for quick button(2)	734S0-6-2539-00	400L	1
32R	Upper cable for quick button(1)	734S0-6-2542-00	400L	1
33	Upper cover for handpulse	747S0-6-2517-B0	184.5*20.8*50	2
34	Lower cover for handpulse	747S0-6-2518-B0	184.5*35.2*50	2
35L	Membrane button(-)	734S0-6-2534-00	D39	1
35R	Membrane button (+)	734S0-6-2533-00	D39	1
36	Handlebar	734S0-3-2400-J1		1
37L	Lower cable for quick button(2)	747S0-6-2536-00	850L	1
37R	Lower cable for quick button(1)	747S0-6-2544-00	850L	1
38	Screw	52842-2-0015-F0	ST4.2*15L	32
39	Cross bolt	52605-2-0012-F0	M5*0.8*12L	16
40	Back cover for console	747S0-6-2529-B0	337.6*225.5*58.4	1
41	Bolt	50108-5-0050-F3	M8*1.25*50L	2
42	Rear protective cover for handlebar	734S0-6-3781-B0	97.2*75*42	1
43	Front protective cover for handlebar	734S0-6-3780-B0	100*77.1*42	1
44	Flat washer	55120-1-2615-NA	D26*D21*1.5T	1
45	Crank cover	734S0-6-4524-C0	D150*D41*14.2	2
46	Left chain cover	73402-6-4501-B0	728*98.3*519	1
47	Right chain cover	734S0-6-4502-B0	728*101.7*519	1
48L	Left crank	58007-6-1093-C0	170Lx9/16"-20BC	1
48R	Right crank	58007-6-1094-C0	170Lx9/16"-20BC	1
49	Anti-loosen nut	734S0-6-2775-N0	M10*1.25*9T	2
50	Bolt cover	734S0-6-2779-C0	D29*11.5L	2
51L&51R	Pedal	58029-6-1105-B0	JD-36A	1
52	Screw	54006-5-0015-D0	M6*1.0*15L	4
53	Spring washer	55106-2-1013-NA	D10.5*D6.1*1.3T	4
54	Flat washer	55106-1-1310-NA	D13*D6.5*1.0T	4
55	Self-generator system	734G0-3-3102-00	D242.7*84.5*13.5kg	1
56	Pin	71600-6-4586-60	D6*26.5*7.7	12
57	Connecting cable	738G0-6-3177-00	500L	1

58	Connecting cable(2)	747G0-6-3182-00	1000L	1
59	"Battery connecting cable "	818G0-6-2553-01	750L	1
60	Buffer	818G0-6-2594-B0	25*2T*80	2
61	Chargeable battery	818G0-6-2554-00	12V 2.6Ah	1
62	Fixing board(1)	818G0-6-1085-BA0	77*48*2.0T	1
63	Upper computer cable	747G0-6-2572-00	300L	1
64	Middle computer cable	734G0-6-2587-00	1000L	1
65	Lower computer cable	734G0-6-2573-00	1350L	1
67	Tension cable	734S1-6-2603-00	D1.5x465L	1
68	Controller	818G0-6-2597-00	GEM-C03	1
69	Saddle	58001-6-1352-B0	LS-A13	1
71L	Left gasket for chain cover	734S0-6-4548-B0	179.9*52.1*21.2	1
71R	Right gasket for chain cover	734S0-6-4549-B0	179.9*52.1*21.2	1
72	Adjustable tube for saddle	734S0-3-4000-A40		1
73	Sensor cable	805S0-6-2576-00	500L	1
74	Power delivery cable	807S1-6-2596-00	700L	1
75	Upper protective cover	734S0-6-4580-B0	170*147*125.5	1
76	Computer	734G1-6-2501-B0	SR-8627-31	1
77	C ring	55517-1-0010-00	S-17(1T)	1
78	Waved washer	55117-5-2203-DA	D17*D22*0.3T	3
79	Bearing	58006-6-1044-00	6203-2RS SKF	2
82	Flat washer	55108-1-2830-NA	D28*D8.5*3T	1
83	Plastic cover	803K0-6-1082-00	D3*30L	2
84	Spring	58003-6-1013-N1	D2.2*D14*55L	1
85	Fixing plate for idle wheel	734S0-3-1600-00		1
86	Plastic flat washer	55110-1-2404-BF	D10*D24*0.4T	2
87	Hex nut	55208-2-2006-NA	M8*1.25*6T	1
88	Nylon nut	55208-1-2008-FA	M8*1.25*8T	3
89	Adjustable rod	734S0-3-2225-N0		1
90	Allen bolt	51608-5-0016-F0	M8*1.25*16L	2
91	Spring	58003-6-1078-N0	D1.5*D14*50L	1
92	Bolt	53205-2-0040-N0	M5*0.8*40L	1
93	Fixing bar	734S0-6-2210-N0	D6*49L	1

94	Tighten gasket	734S0-6-4086-B0	D38*11T	1
95	Allen screw	54006-5-0045-F3	M6*1.0*45L	1
96	Pull handle	734S0-6-2274-B0	152.5*53*32.2	1
97	End cap for adjustable handle	734S0-6-4085-B0	74*D37*3T	1
98	Square neck bolt	50508-5-0050-D3	M8x1.25x50L	1
99	Buffer	55308-4-0020-G9	D10.5*20L	2
100	Block plate	734S0-6-4073-N0	31*31*6T	1
101	Moving wheel	26100-6-1087-B0	D65*24	2
102	Round head cross screw	50805-2-0010-F0	M5x0.8x10L	4
103	Inner hex fastening screw	54605-2-0012-D0	M5*0.8*12L	2
104	Water bottle holder	747S0-6-2074-B0	113*138.3*120.5	1
105	Water bottle holder(rear)(black)	749S0-6-2092-B0	203.1*189*157.4	1
106	Water bottle holder(front)(black)	749S0-6-2091-B0	189*154.2*67.9	1
107	Cap	55376-1-0016-B8	D76*16	4
108	Adaptor	831D2-6-2584-00	output 12V,2A	1
109	Earphone plug	747S0-6-4590-B0	10*9.5*5	1
	Allen spanner	58030-6-1031-N1	M6	1
	Open spanner	58030-6-1035-N1	155*30*5T	1

8.3 Exploded Drawing

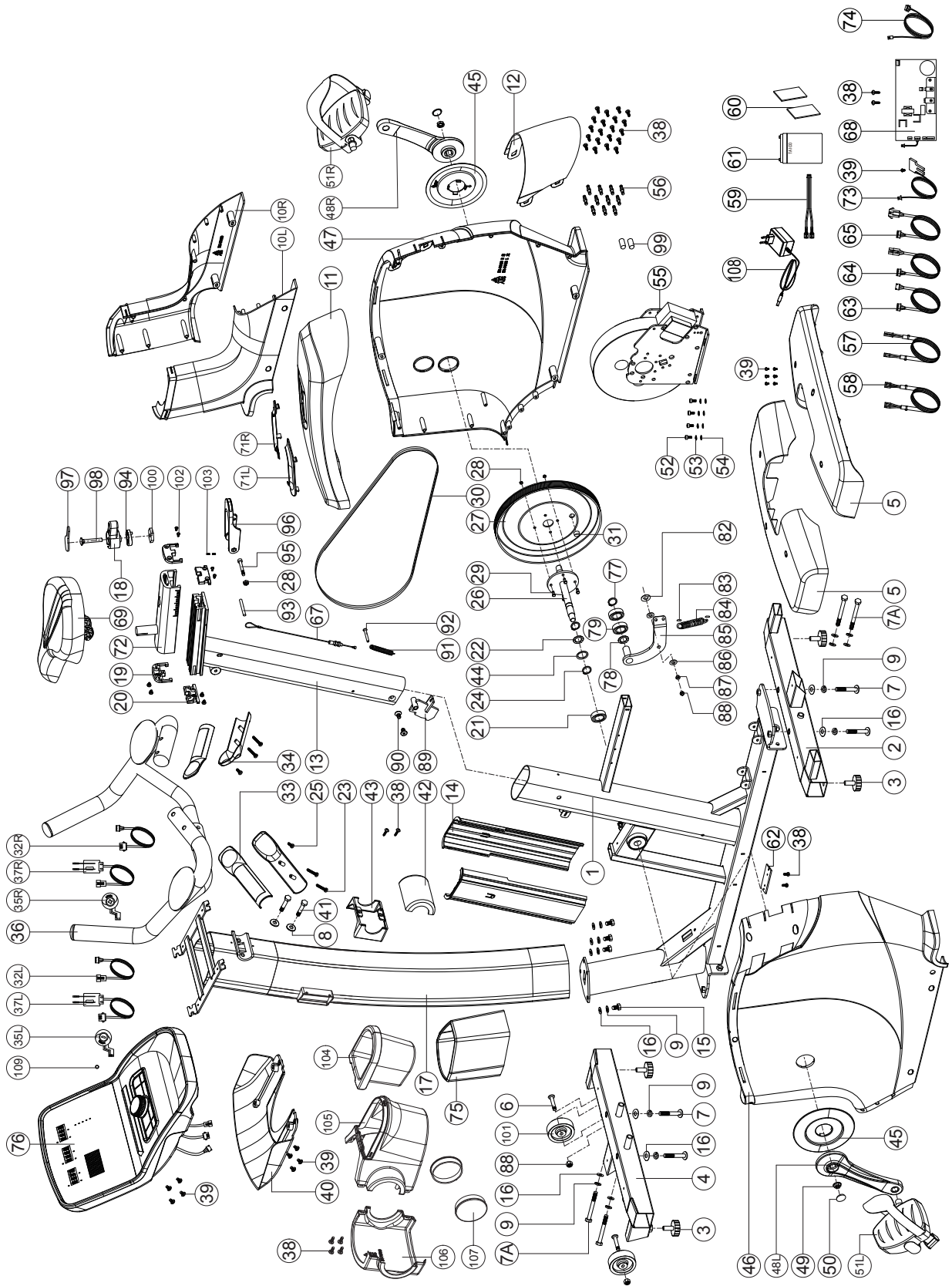

Products from TAURUS® are subject to strict quality control. However, if a fitness equipment purchased from us does not work perfectly, we take it very seriously and ask you to contact our customer service as indicated. We are happy to help you by phone via our service hotline.

Error Descriptions

Your fitness equipment is developed for long-term, high-quality training. However, should a problem arise, please first read the operating instructions. For further assistance, please contact your contract partner or call our service hotline. To ensure your problem is solved as quickly as possible, please describe the defect as exactly as possible.

In addition to the statutory warranty, we provide a warranty for every fitness equipment purchased from us according to the following provisions.

Your statutory rights are not affected.

Warranty

The warranty is the first/original buyer and/or any person who received a newly purchased product as a gift from the original buyer.

Warranty period

The warranty periods, shown on our web shop, begin on delivery of the fitness equipment. The respective warranty periods for your equipment can be found on its product website.

Repair Costs

According to our choice, there will either be a repair, a replacement of individual damaged parts or a complete replacement. Spare parts, that have to be mounted while assembling the equipment, have to be replaced by the warranty holder personally and are not a part of repair. After the expiration of the warranty period, the responsibility for parts costs, repair costs, installation costs and delivery costs lies with the warranty holder.

The terms of use are defined as follows:

- + Home use: solely for private use in private households up to 3 hours per day
- + Semi-professional use: up to 6 hours per day (e. g. rehabilitation centres, hotels, clubs, company gyms)
- + Professional use: more than 6 hours per day (e. g. commercial gyms)

Warranty Service

Within the warranty period, equipment which develops faults as a result of material or manufacturing defects, will be repaired or replaced at our discretion. Ownership of equipment or parts of equipment which have been replaced is transferred to us. The warranty period is not extended nor does a new warranty period begin following repair or replacement under the warranty.

Warranty Conditions

For the warranty to be valid, the following steps must be taken:

Please contact our customer service by email or phone. If the product under warranty has to be sent in for repair, the seller bears costs. After expiry of the warranty, the buyer bears the costs of transport and insurance. If the fault is covered by our warranty, you will receive a new or repaired equipment in return.

Warranty claims are invalid in case of damage resulting from:

- + misuse or improper handling
- + environmental influences (moisture, heat, electrical surge, dust, etc.)
- + failure to follow the current safety measures for the equipment
- + failure to follow the operating instructions
- + use of force (e. g. hitting, kicking, falling)
- + interventions which were not carried out by one of our authorized service centres
- + unauthorised repair attempts

Proof of Purchase and Serial Number

Please make sure that you are able to provide the appropriate receipt when claiming on your warranty. So that we can clearly identify the model of your equipment, and for the purposes of our quality control, you will need to give the serial number of your equipment, when contacting the service team. Where possible please have your serial number and your customer number ready when you call our service hotline. It will help us to deal with your request swiftly.

If you cannot find the serial number on your fitness equipment, our service team is at your disposal to offer further information.







































Service outside of the Warranty Period

We are also happy to issue an individual cost estimate if there is a problem with your fitness equipment after the warranty has expired, or in cases which do not fall under the terms of the warranty, e. g. normal wear and tear. Please contact our customer service team to find a quick and cost-effective solution to your problem. In such a case you will be responsible for the delivery costs.

Communication

Many problems can be solved just by speaking to us as your specialist supplier. We know how important it is to you as a user of the fitness equipment to have problems solved quickly and simply, so you can enjoy working out with minimal interruption. For that reason, we also want to resolve your queries quickly and in a straightforward manner. Thus, please always keep your customer number and the serial number of the faulty equipment handy.

10 CONTACT

DE	DK	UK
<p>TECHNIK</p> <p> +49 4621 4210-900</p> <p> +49 4621 4210-698</p> <p> technik@fitshop.de</p> <p> Öffnungszeiten entnehmen Sie unserer Homepage.</p> <p>SERVICE</p> <p> 0800 20 20277 (kostenlos)</p> <p> 04621 4210 - 0</p> <p> info@fitshop.de</p> <p> Öffnungszeiten entnehmen Sie unserer Homepage: https://stg.fit/statita</p>	<p>TEKNIK OG SERVICE</p> <p> 80 90 16 50</p> <p>+49 4621 4210-945</p> <p> info@fitshop.dk</p> <p> Åbningstider kan findes på hjemmesiden: https://stg.fit/statit7</p> <p>FR</p> <p>TECHNIQUE & SERVICE</p> <p> +33 (0) 189 530984</p> <p>+49 4621 42 10 933</p> <p> info@fitshop.fr</p> <p> Vous trouverez les heures d'ouverture sur notre site Internet: https://stg.fit/statit4</p>	<p>CUSTOMER SUPPORT</p> <p> 00800 2020 2772</p> <p>+494621 4210 944</p> <p> info@fitshop.co.uk</p> <p> You can find the opening hours on our homepage: https://stg.fit/statitc</p> <p>BE</p> <p>TECHNIQUE & SERVICE</p> <p> 02 732 46 77</p> <p>+49 4621 4210 933</p> <p> info@fitshop.be</p> <p> Vous trouverez les heures d'ouverture sur notre site Internet: https://stg.fit/statit8</p>
<p>ES</p> <p>TECNOLOGÍA Y SERVICIOS</p> <p> 911 238 029</p> <p> info@fitshop.es</p> <p> Consulta nuestro horario de apertura en la página web: https://stg.fit/statit5</p>	<p>NL</p> <p>TECHNISCHE DIENST & SERVICE</p> <p> +31 172 619961</p> <p> service@fitshop.nl</p> <p> De openingstijden vindt u op onze homepage: https://stg.fit/statit3</p>	<p>INT</p> <p>TECHNICAL SUPPORT & SERVICE</p> <p> +49 4621 4210-944</p> <p> service-int@fitshop.de</p> <p> You can find the opening hours on our homepage: https://stg.fit/statita</p>
<p>PL</p> <p>DZIAŁ TECHNICZNY I SERWIS</p> <p> 22 307 43 21</p> <p>+49 4621 42 10-948</p> <p> info@fitshop.pl</p> <p> Godziny otwarcia można znaleźć na stronie głównej: https://stg.fit/statit6</p>	<p>AT</p> <p>TECHNIK & SERVICE</p> <p> 0800 20 20277 (Freecall)</p> <p>+49 4621 42 10-0</p> <p> info@fitshop.at</p> <p> Öffnungszeiten entnehmen Sie unserer Homepage: https://stg.fit/statitb</p>	<p>CH</p> <p>TECHNIK & SERVICE</p> <p> 0800 202 027</p> <p>+49 4621 42 10-0</p> <p> info@fitshop.ch</p> <p> Öffnungszeiten entnehmen Sie unserer Homepage: https://stg.fit/statit9</p>

Please find a detailed overview including address and opening hours for all stores of the Fitshop Group in Germany and abroad on the following website:

www.fitshop.com/en/stores

WE LIVE FITNESS

WEBSHOP AND SOCIAL MEDIA

Fitshop is Europe's largest specialist store for home fitness equipment with currently over 70 stores and one of the world's most renowned online mail order companies for fitness equipment. Private customers order via the 25 web shops in the respective national language or have their desired equipment assembled on site. In addition, the company supplies fitness studios, hotels, sports clubs, companies and physio practices with professional equipment for endurance and strength training.

Fitshop offers a wide range of fitness equipment from renowned manufacturers, high-quality in-house developments and comprehensive services, such as a build-up service and sports scientific advice before and after the purchase. The company employs numerous sports scientists, fitness trainers and competitive athletes.

Visit us also on our social media platforms or our blog!

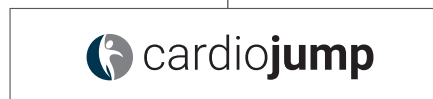
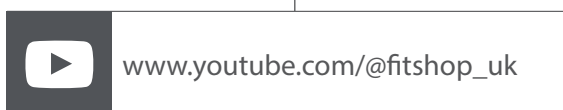
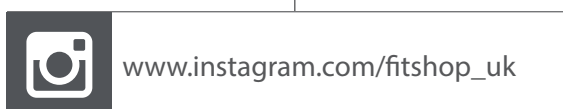

TAURUS[®]

Upright Bike UB10.5 Pro